

PTC® Live Global

PTC 103 - PTC Windchill Roadmap



Kevin Wrenn

Divisional GM, PLM Segment



Darryn Kozak

VP Product Management

June 2015



CUSTOMERS

*Extend and maximize
the value of your PTC
Windchill investment*

INNOVATION

*The PLM platform for IoT
and Smart, Connected
Products*

FUTURE

The next step in PLM

CUSTOMERS

PTC Windchill
10.2 M030

Administration | Performance | Usability |

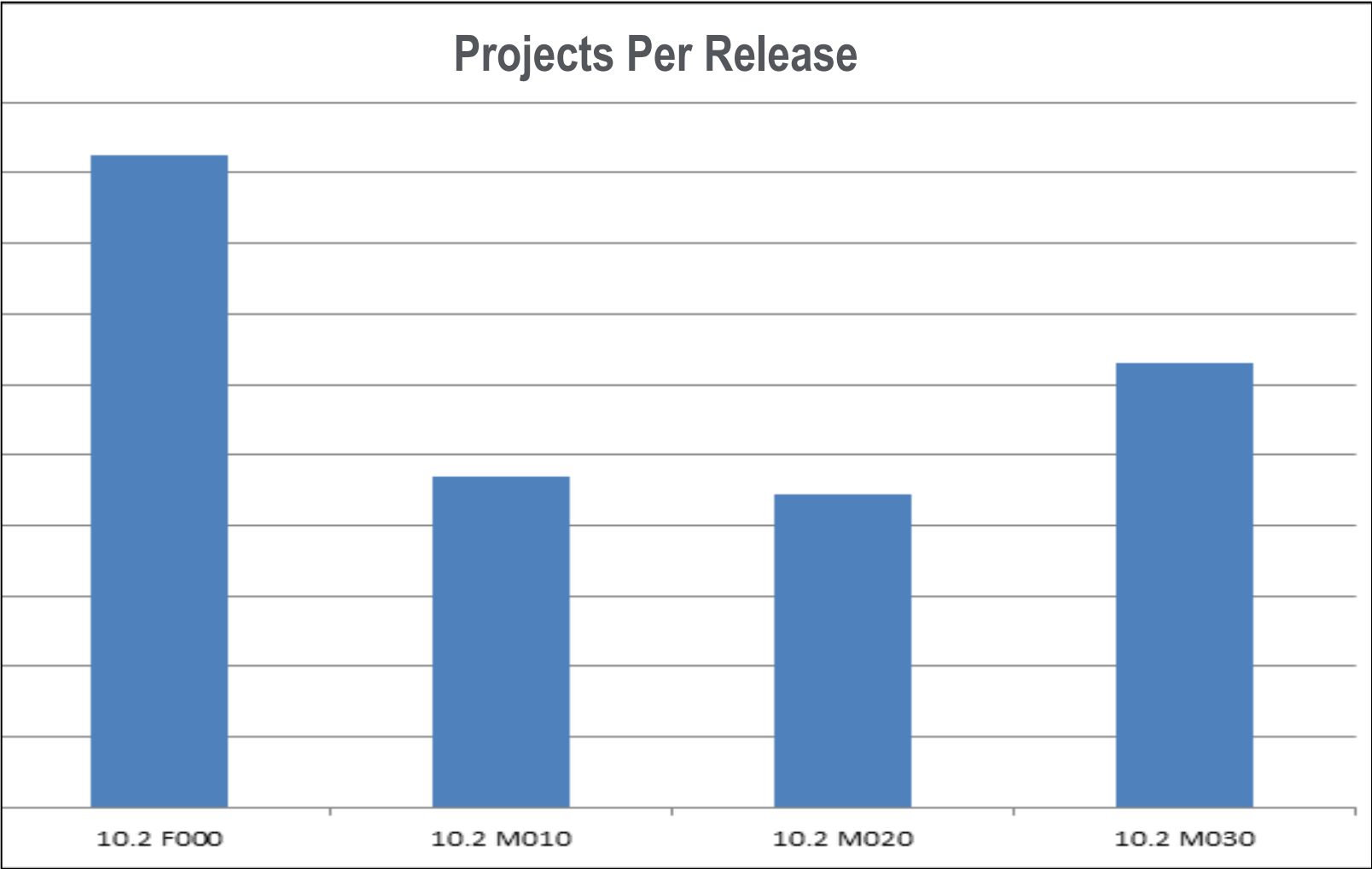

Investment in capabilities aligned with customer requirements

Role Based Apps

Connected PLM

xBOM

INNOVATION

PTC Windchill
'X-26'

View 3-D Section Exploded

Property Summary

6289427 Derailleur Assembly Version C.4 Released
 Last modified: 12/20/2014 Cost: \$52.36
 Last modified by: Jim Smith Quantity In Stock: 507
 Manufacturer: SRAM

Parts List

Part Number	Description	Quantity	Unit	Lot Size	In Stock	Unit Cost	Vendor
5648291	B-Knuckle	1	ea	400	1,200	1.07	SRAM
5622654	Outerlink	1	ea	400	1,200	1.02	SRAM
5613205	Pivot Pin	4	ea	400	1,600	.28	Acme
5475310	P-Knuckle	2	ea	200	800	.79	SRAM
5920783	Bolt Bushing	1	ea	600	1,200	.22	Han
5951726	Fin	1	ea	200	1000	.23	SRAM
5639464	Seal	8	ea	1,000	10,000	.14	Han
5796453	O-ring	8	ea	1,000	8,000	.08	Han
5688517	External Retaining Ring	8	ea	1,000	6,000	.07	Han
5688517	Outer Cage	1	ea	400	650	.96	SRAM
5688517	Inner Cage	1	ea	400	625	.98	SRAM
5688517	Pulley	2	ea	400	1,350	.91	SRAM
5688517	Spring	1	ea	600	923	.62	Leroy

Formats

PDF IGES STEP

PTC is uniquely positioned to deliver this to the market

Role Based Apps

Connected PLM

xBOM

INNOVATION

Windchill – Integrity Lifecycle Manager Integration

- Associate requirements to Windchill product information
- Lightweight “App” to view and establish relationships
- Easily view Windchill information from Integrity Lifecycle Manager or Integrity Lifecycle Manager information from Windchill
- Coordinate product changes which include requirements, software, and hardware
- Capture all product information in the release process

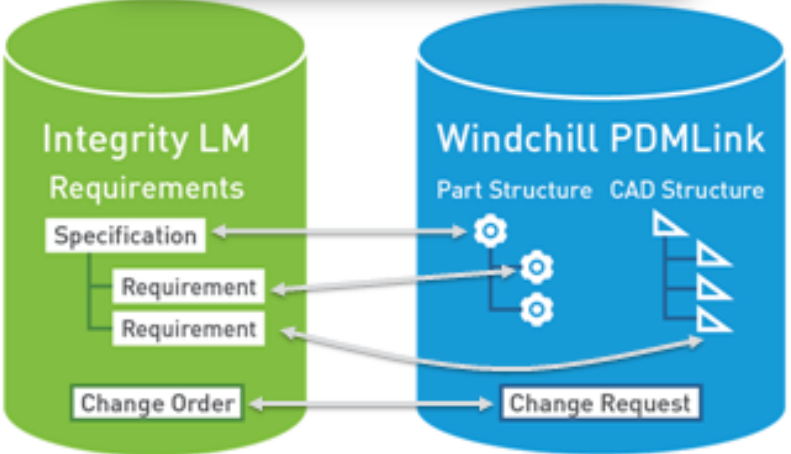
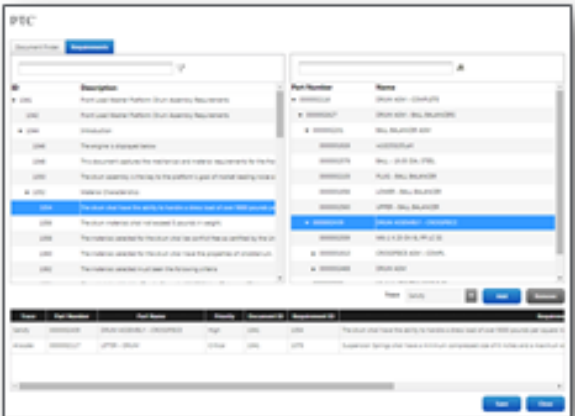

PTC Windchill ‘X-26’

PTC is uniquely positioned to deliver this to the market

Role Based Apps

Connected PLM

xBOM

INNOVATION

PTC Windchill 'X-26'

Improvements with PTC's Engineering Bill of Materials

PTC®

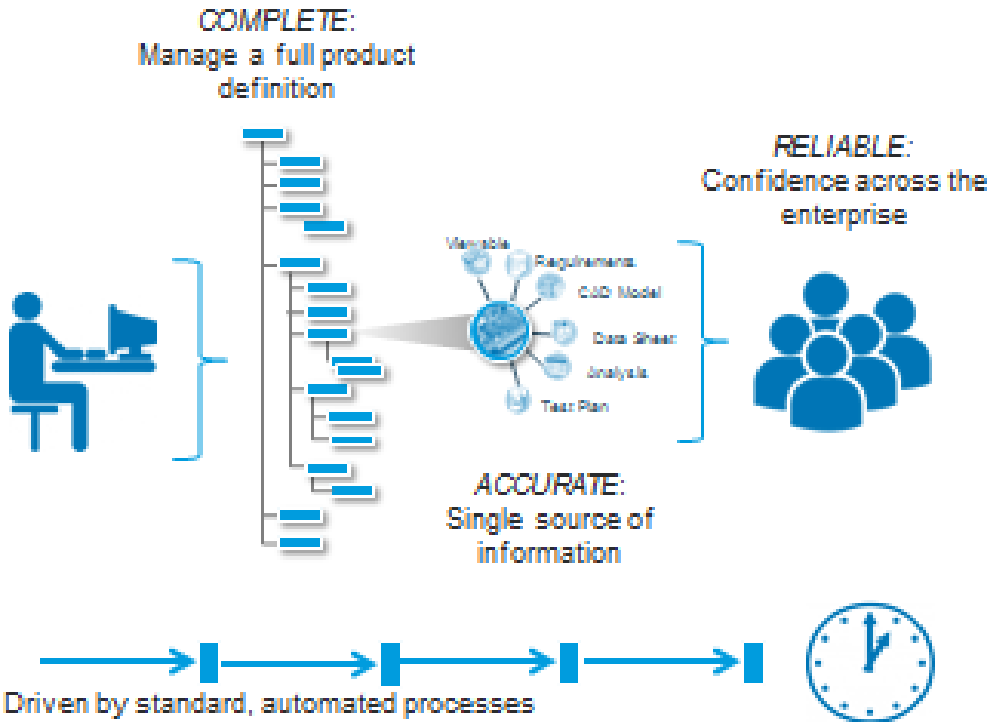

- Find & reuse information
- Process efficiency
- On-schedule releases
- Better decisions

PTC is uniquely positioned to deliver this to the market

Digital Twin

Augmented Reality

Feedback Loops

FUTURE

PTC Windchill
2020



Merging the digital and physical worlds

CUSTOMERS

INNOVATION

FUTURE

PTC Windchill
10.2 M030

PTC Windchill
'X-26'

PTC Windchill
2020

PLM Sessions @ PTC Live 2015 (not a complete list)

Topic	Date	Time	Room	Topic	Date	Time	Room
PTC Windchill Business and System Administration Roadmap	6/8/2015	1:15PM	Lincoln C	Smart, Connected Products Need Electronics: How to Manage Them with PTC Windchill	6/9/2015	1:15PM	Jackson AB
PTC PLM Cloud: Fueling Business Agility and Reducing Costs	6/8/2015	1:15PM	Hermitage AB	Managing the SKU Development Process for Consumer Products	6/9/2015	2:15PM	Lincoln DE
Consolidating Multiple CAPA Systems: The Case for Quality Management in PLM	6/8/2015	2:15PM	Hermitage D	Improving PTC Windchill Performance	6/9/2015	4:00PM	Jackson AB
Best Practices for Managing Your Product Configurations	6/8/2015	2:15PM	Lincoln DE	Driving Part Re-Use: ROI and Best Practices for Maximize Design Reuse	6/9/2015	5:00PM	Jackson AB
Process Planning Management with PTC Windchill MPMLink	6/8/2015	2:15PM	Hermitage AB	Moving from PDM to PLM: The Value of Associative BOM	6/10/2015	8:15AM	Hermitage D
Part Types in PTC Windchill	6/8/2015	4:00PM	Lincoln DE	Smart, Connected Products and PLM: The Future is Here	6/10/2015	9:15AM	Tennessee B
Unified Search in PTC Windchill	6/8/2015	5:00PM	Hermitage AB	Moving to MBOM (Unifying Engineering and MFG Planning) with PTC Windchill MPMLink	6/10/2015	10:30AM	Jackson AB
Model Based Design: 3D Product Development for a 3D World	6/8/2015	4:00PM	Hermitage AB	Connecting PLM to PTC: Improving Support and Maintenance	6/10/2015	10:30AM	Hermitage D
Managing Configurable Product Platforms	6/9/2015	10:00AM	Presidential Boardroom A	PTC Role-Based Applications	6/10/2015	11:30AM	Washington B
Change Management Best Practices: Executing the Change Process	6/9/2015	10:00AM	Jackson AB	PTC's Own Smart Connected Applications	6/10/2015	11:30AM	Jackson EF
Leveraging PTC Creo Unite in a Data				Monitoring PTC Windchill through PTC System Monitor and User Experience			

- Windchill Product Releases and Release Strategy
- Business and System Administration Improvements
- Windchill PLM User Features and Improvements



PTC Windchill

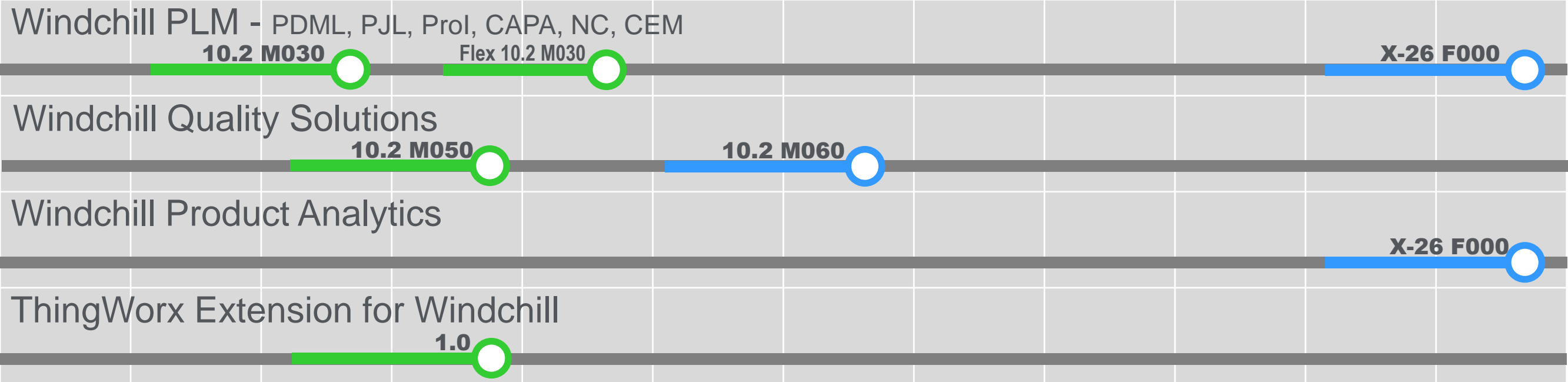

Enterprise Administration

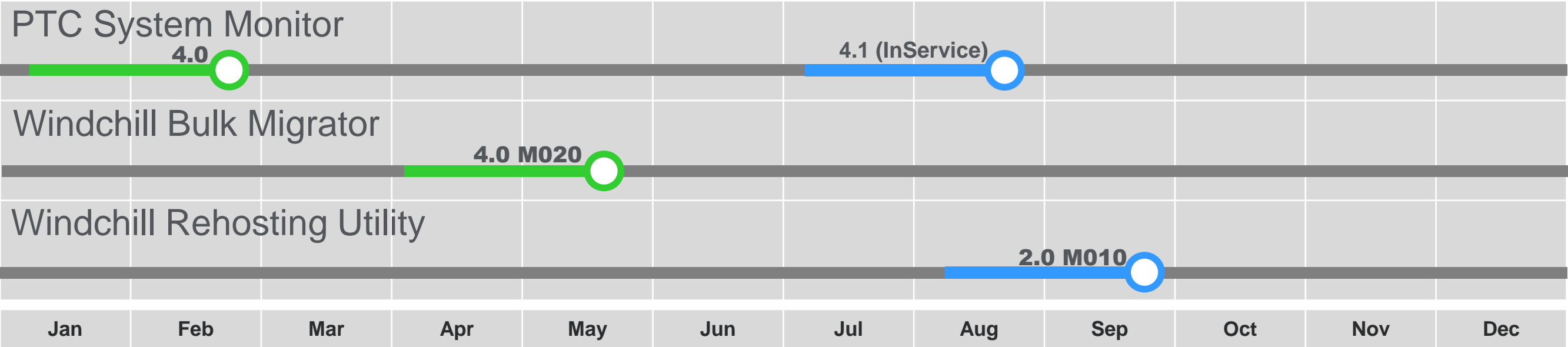

Forward Looking information, subject to change without notice

Adoption of Industry Best Practices to Reduce Customer Effort & Risk

- Limited number of feature enhancement releases
- “CPS” (critical patch set) releases
 - Delivered with a single patch installation
 - They include fixes only, no new features
- Improved Quality
- Improved Client Interoperability
 - With asynchronous WWGM client releases
 - So that customers can stagger Windchill client and server upgrades independently

PTC Windchill 10.2 and later

Major Releases

- **Every 12 to 18 Months**

Maintenance Releases

- **Two or Three**
- Defect fixes
- Selected features - minimal user impact

Critical Patch Sets (CPS)

- **Cumulative, Issued every 30 Days**
- Contain only significant customer fixes
- No feature content

Forward looking – Actual Dates Will Change

Code Name	Release Identifier	Projected RTM Date	Release Type
X-26	X-26 F000	December 2015	Major Release Resets support window Significant platform support changes Short-term CPS support
Athens	X-26 M010	CQ2 2016	Maintenance Release Minor platform support changes Short-term CPS support
Berlin	X-26 M020	CQ4 2016	Maintenance Release Minor platform support changes Long-term CPS support
Cairo	“Cairo” F000	2017	Major Release Resets support window Significant platform support changes Short-term CPS support
Dresden	“Dresden” M010	2017	Maintenance Release Minor platform support changes Short-term CPS support

Business and System Administration Improvements

Enables Administrators to Promote Administrative Data as it matures through Test to Production systems

10.2 M030

Selective Mode
Selectivity on Export
Matching based on Business Identity

Synchronized Mode
Domain level selectivity on Export
Matching based on Object ID

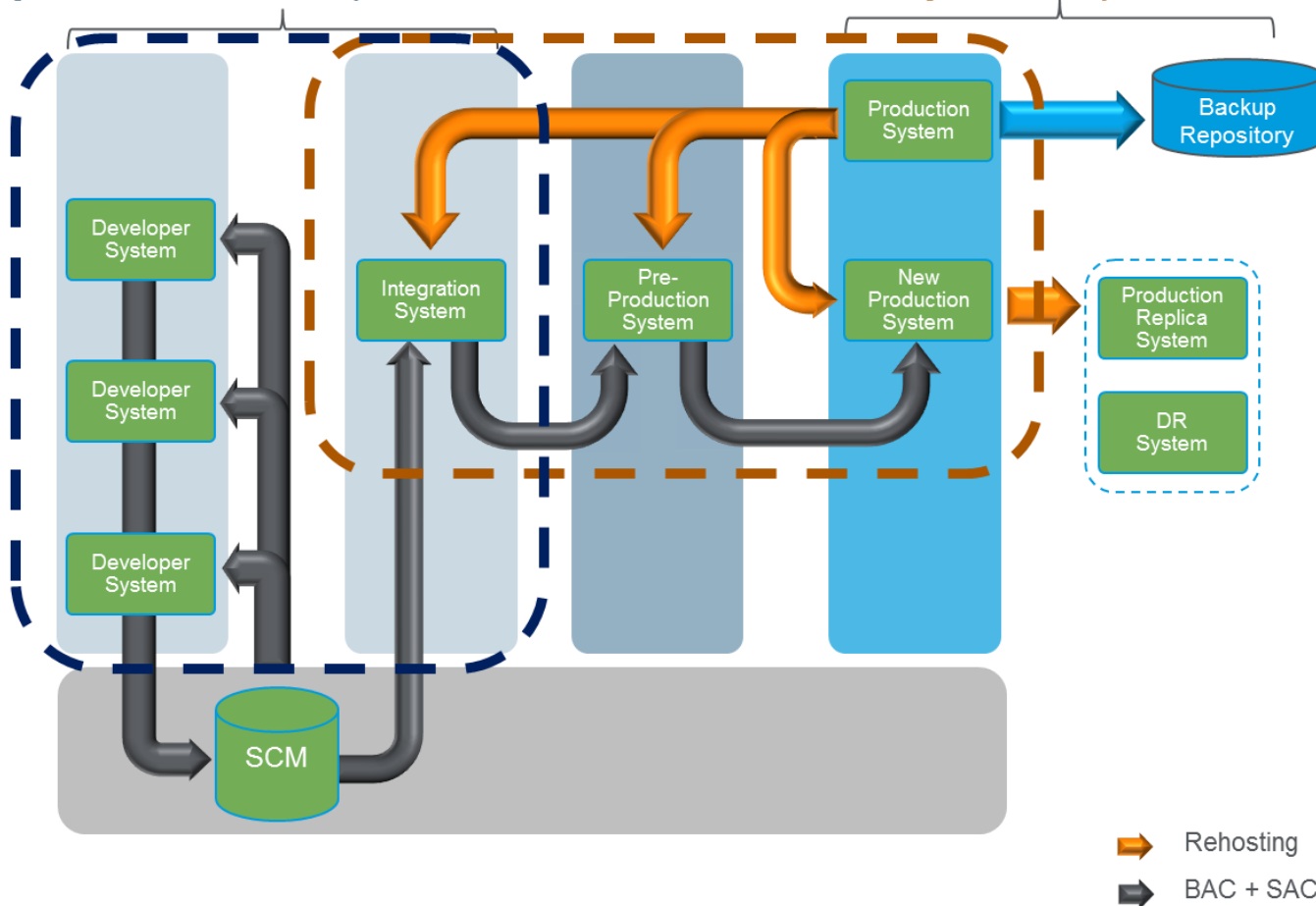

- Administrative Data Types:

- Policy Access Control Rules
- Profiles

- Supported Modes

- Synchronized Mode
- Selective Mode

- HTML preview and manifest on export

- Windchill X-26 Improvements

X-26 F000

- Support for Object Initialization Rules and Preferences
- Rich export filtering capabilities for Selective Mode
- Conflict handling for Delete Operations
- Enhanced Import log file

An application for performance and reliability monitoring of PTC Products – Based on Dynatrace 6.1

10.2 M030

- **Support for Additional PTC Enterprise Products**
 - Windchill Quality Solutions 10.2 M040 and later
 - Windchill MPMLink
 - Windchill PartsLink
 - Servigistics Knowledge Management 5.4
 - Servigistics Knowledge and Diagnostics 5.5 and later
 - InService 6.0
- **Additional Support for Windchill Business Transactions**

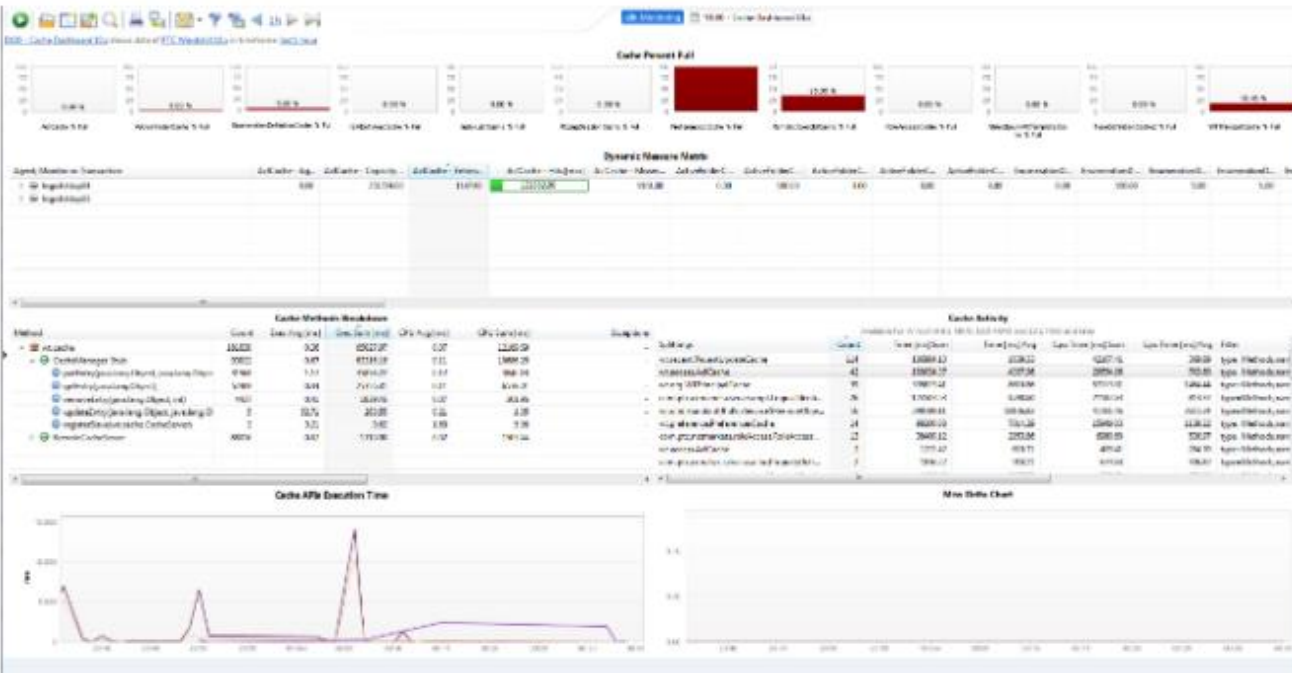

- MPMLink Operations**
- Part Allocation
- Rename Operation
- Search in Tree Picker
- Work Instruction

- Options and Variants Operations**
- Assign Expression
- Configure Option Filter
- Create Rule
- Delete Operation
- Edit Option Filter
- Option Pool Structure
- Option Set Structure
- Preview Variant Structure
- View Conditional Rules
- View Enable Rules
- View Exclude Rules
- View Include Rules

- ProjectLink Transactions**
- Convert to PDM Checkout
- Convert to Share
- Edit Multiple Assignments
- Edit Selected Objects
- Export / Import Plan
- Insert Activity
- New / Multiple Activities
- Send to PDM
- Update Project
- Update Selected Shares
- View in Gantt Explorer

- PartsLink Operations**
- Classification Search
- Classify Part
- Create Classification Node
- Edit Classification

Monitoring PTC Windchill through PTC System Monitor and User Experience Management

- Security Labels in the Workspace
 - View security label information without leaving the context of the workspace
 - Ability to set security labels during workspace checkin
- Related Agreements Report
 - Find Agreements that affect a part or document

- New Security Label batch update utility
 - Bulk definition of security labels
- Collection Capabilities for Editing Security Labels
 - Optionally change security labels to all versions of a given object

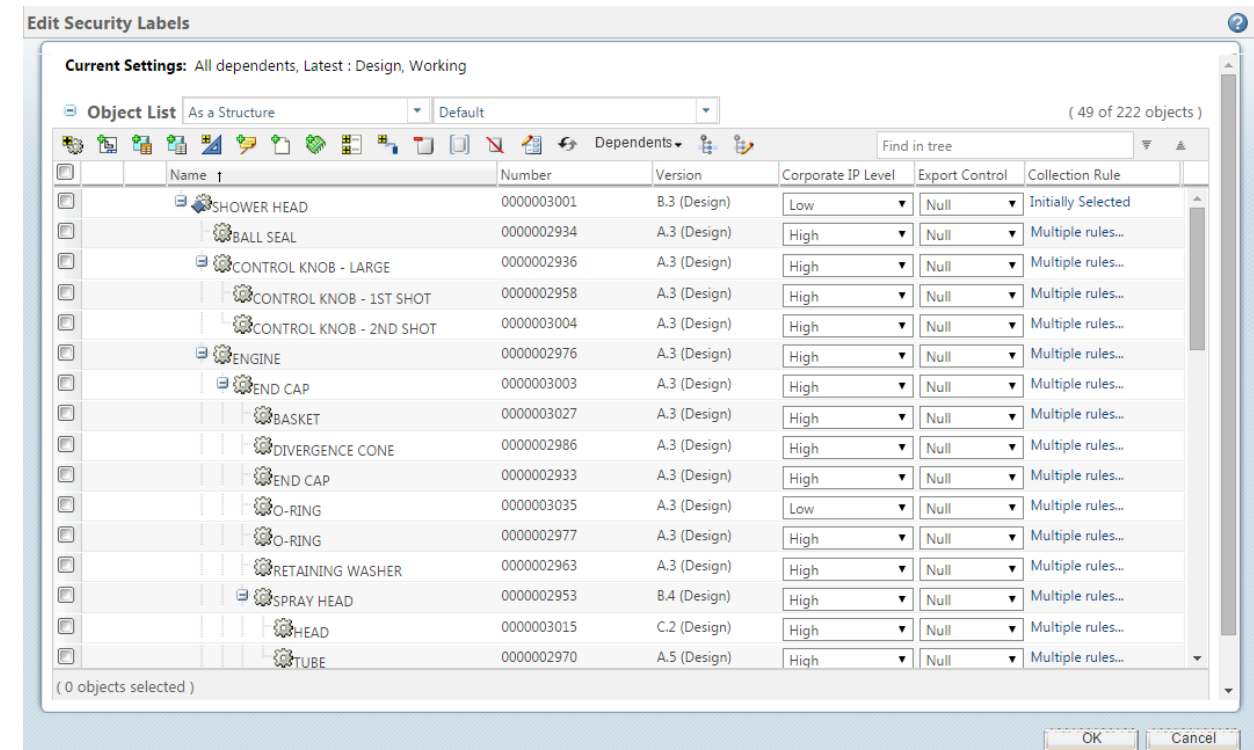
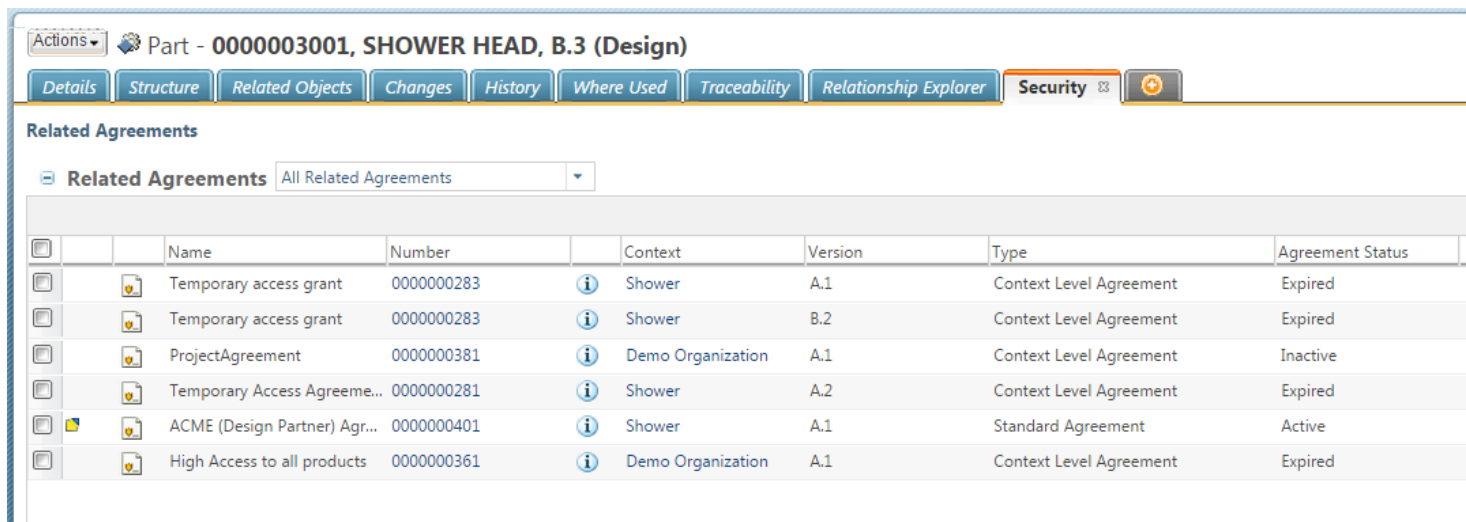

- Individual projects can elect automatic updates

- Configure start time
- Configure users responsible for updates
- Location preference for newly added shares

- Leverages existing scalable process queues

- Benefits

- Improve the quality of collaboration by ensuring up-to-date information
- Improve productivity through the automation of manual repetitive tasks

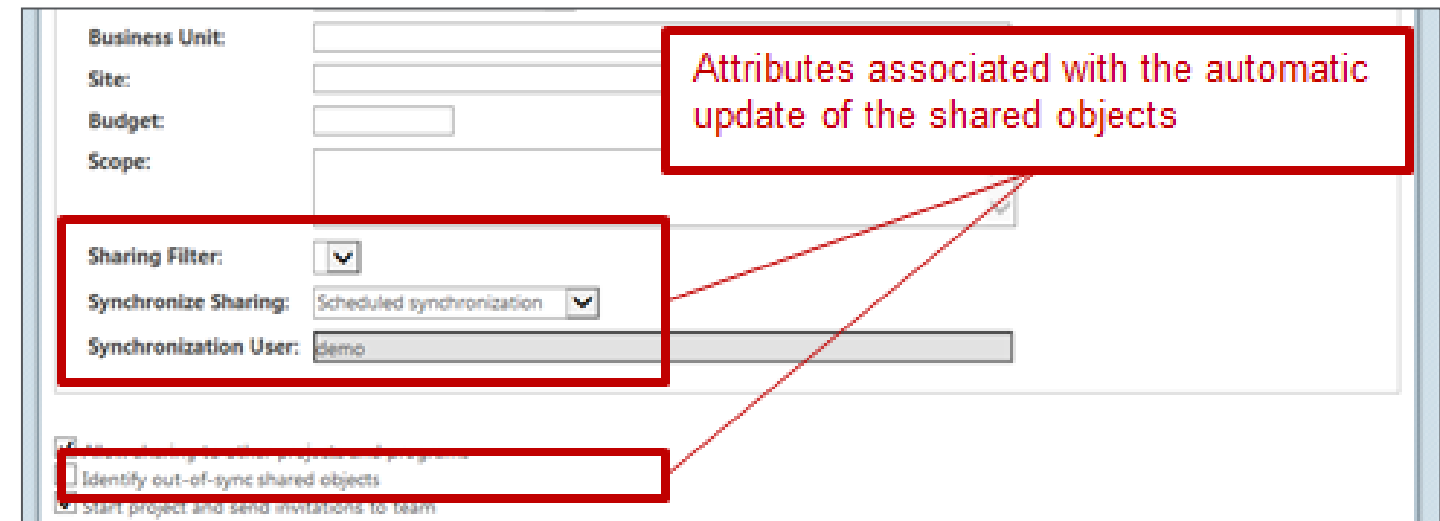
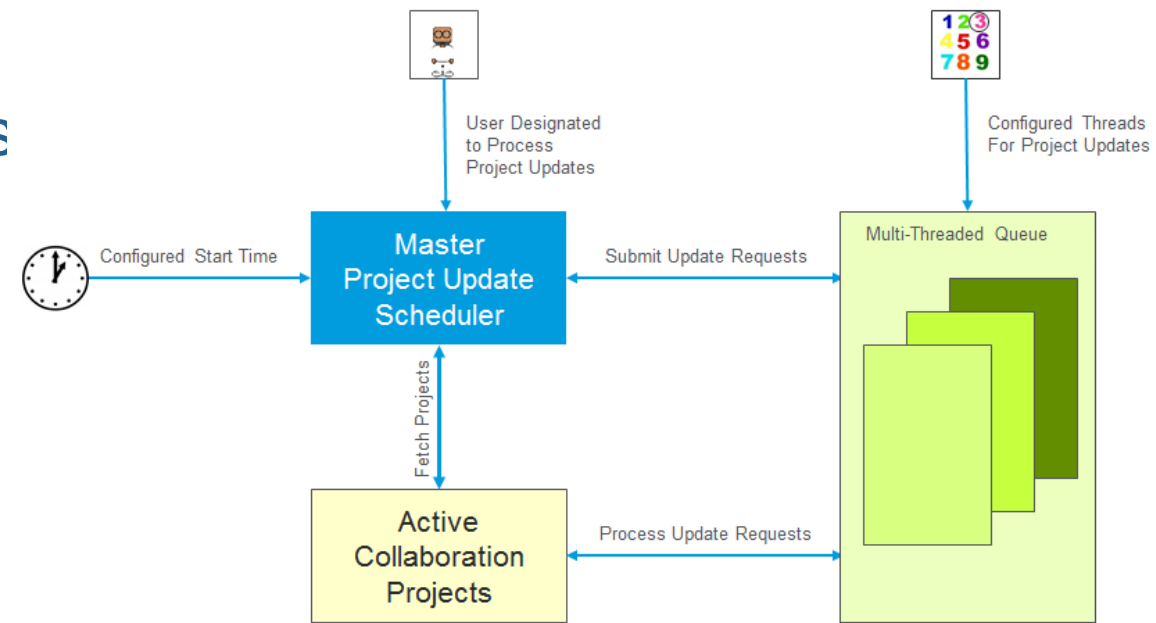

Applet List

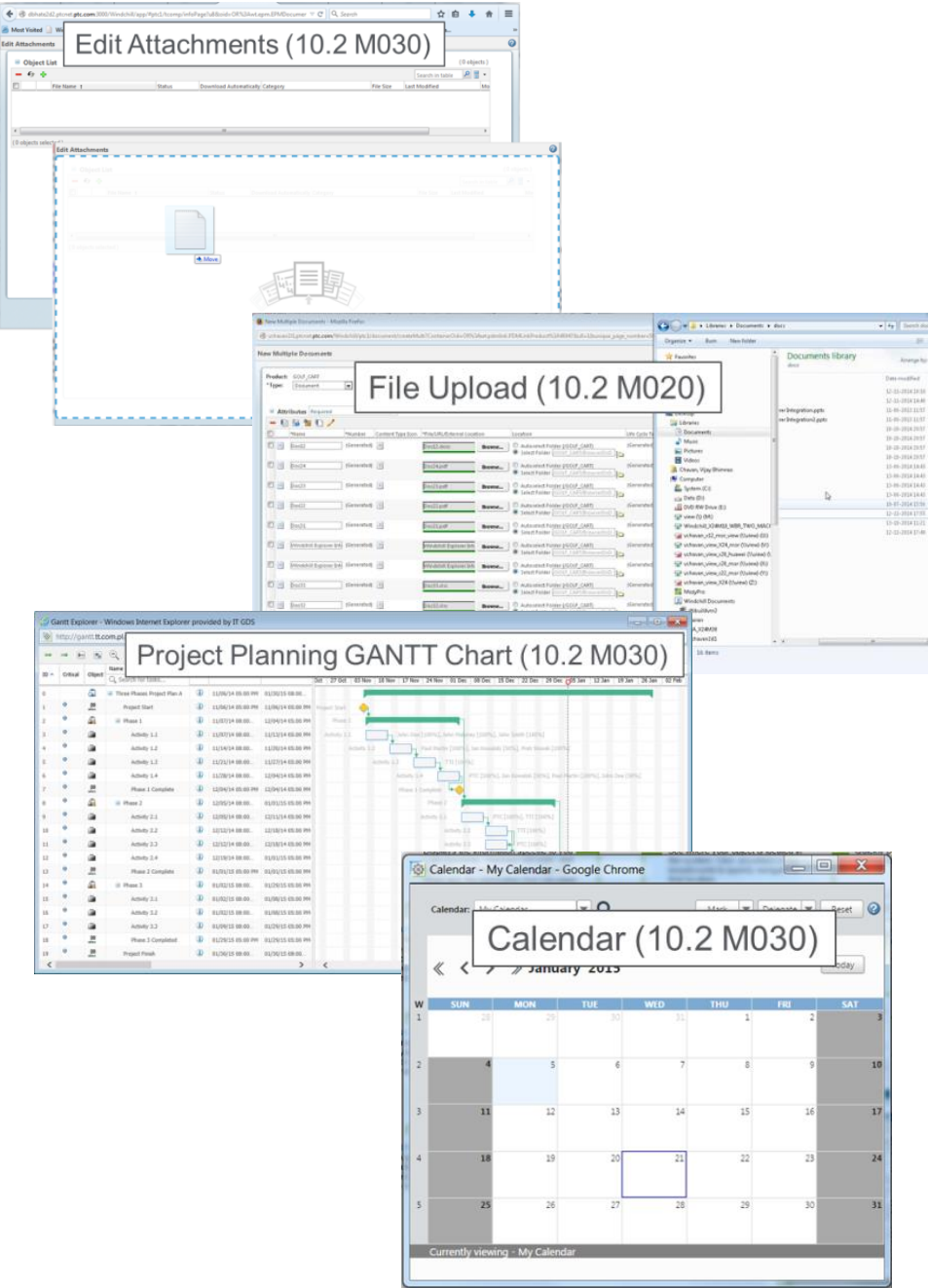

Applet	
File Upload	10.2 M020
Calendar	10.2 M030
Import and Export Utility	
Project Planning GANTT Chart	
Software Download (<i>sign</i>)	
Live Charting (<i>sign</i>)	X-26 F000
Common Participant Picker	
Query Builder	
Software Download	
Policy, Notification, Indexing Administration	
Attribute/Measurement Admin	
Publish MPMLink to ERP	

- Redesign of Query Builder UI
 - Rich Internet Application
 - Enhanced Usability and Intuitiveness
 - Example: Graphical UI to create and edit join conditions
- Enhanced Report Template
 - New Query Modeling Language
 - Results in better Report Builder performance, flexibility and extensibility
 - Query Builder Maintenance Dashboard
 - Enhanced HTML layout improves usability and clarity

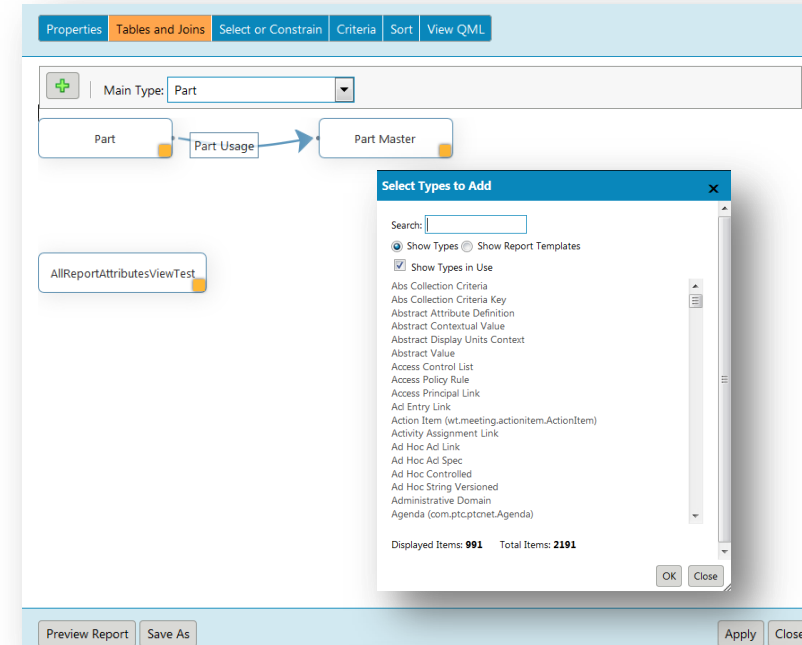

Heading	Attribute	Property	
Section Header	...		-
Name Column	Column	Part.Name	[Icon] [Icon] [Icon]
Part Created	Column	Part.Created	[Icon] [Icon] [Icon]
Part Master Name	Column	Part Master.Name	[Icon] [Icon] [Icon]
View Part Master Name	Report View Attribute	Part Master Name	[Icon] [Icon] [Icon]
View Update Count	Report View Attribute	Update Count	[Icon] [Icon] [Icon]
View Created	Report View Attribute	Created	[Icon] [Icon] [Icon]
View Identity	Report View Attribute	Identity	[Icon] [Icon] [Icon]

Query Builder Maintenance Dashboard						
Report Template Name ^	Upgraded	Eligible for Upgrade	Date Upgraded	Date Last Modified	Date Last Run	
Alias Test	Yes	No		2015-04-30 11:04:30 CDT		
All Average Change Notice Complet...	Yes	Yes	2015-05-18 14:18:39 CDT	2015-04-23 14:28:42 CDT		
All Average Change Request Compl...	No	Yes		2015-04-23 14:28:42 CDT		
All Average Problem Report Comple...	No	Yes		2015-04-23 14:28:42 CDT		
All Change Notice Influx And Resol...	No	Yes		2015-04-23 14:28:42 CDT		
All Change Request Influx And Res...	No	Yes		2015-04-23 14:28:42 CDT		
All Criteria	Yes	Yes	2015-05-06 10:33:50 CDT	2015-05-06 10:33:31 CDT		
All Criteria DO NOT UPGRADE	No	Yes		2015-05-06 10:33:18 CDT		
All Criteria Test 1	Yes	Yes	2015-04-28 14:48:21 CDT	2015-04-28 14:47:56 CDT		
All Criteria W Attribute Ref	Yes	Yes	2015-05-06 16:31:45 CDT	2015-05-06 16:30:31 CDT		
All Criteria W Attribute Ref DO NOT...	No	Yes		2015-05-06 16:30:16 CDT		
All Open Change Notices	No	Yes		2015-04-23 14:28:42 CDT		
All Open Change Requests	Yes	Yes	2015-05-18 14:16:19 CDT	2015-04-23 14:28:42 CDT		
All Open Problem Reports	Yes	Yes	2015-05-18 14:18:00 CDT	2015-04-23 14:28:42 CDT		
All Problem Report Influx And Reso...	No	Yes		2015-04-23 14:28:42 CDT		

PTC Windchill PLM User Features and Improvements

- **Enhanced Platform Rules and Assigned Expressions**
 - Introduce Aliases, and Choices with Numeric values
 - Benefits: Streamline rule and assigned expression definition

Tire Size: 28IN, 30IN, 32IN, 36IN, 48IN
 IF (Tires>=32IN) THEN Fender=FD0102

10.2 M030

- **Advanced Management Support**
 - Change Management of Local Rules
 - Change Management of Assigned Expressions, Independent of Parts
 - Assigned Expressions on Part Occurrences
 - New Administrative Support for Creating Configurations
 - Spreadsheet and API support to create & update configurations (variant specifications)
 - Benefits: Provides additional options for advanced management

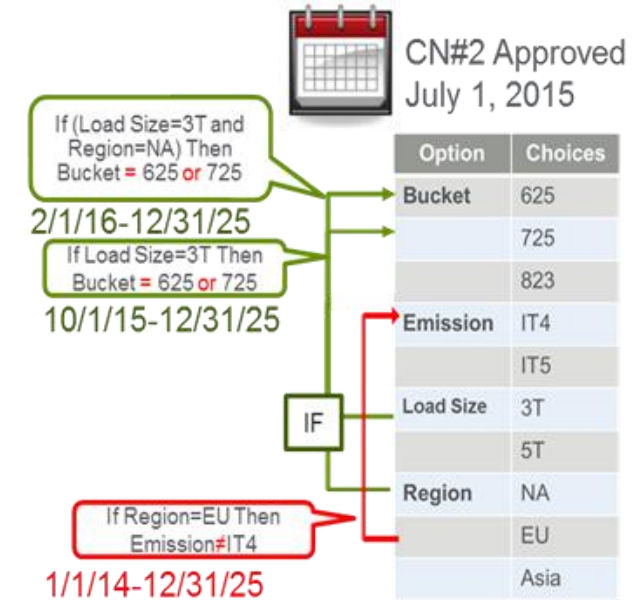

- **Usability and Filtering Enhancements**
 - New filter type – filter out incomplete assigned expressions
 - Tailorable logic expression display
 - Benefits: Display expressions as users expect, and minimize clutter

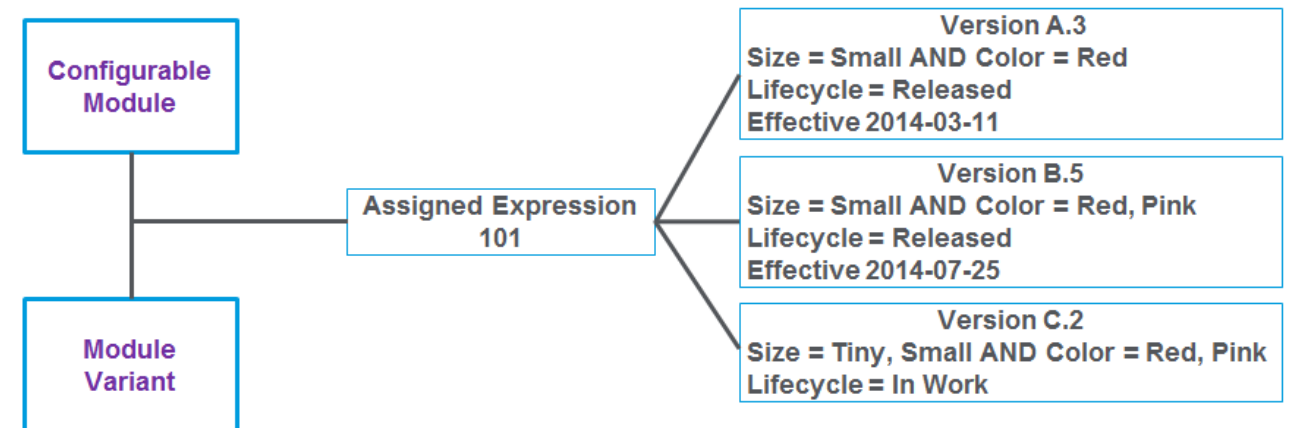

Managing Configurable Product Platforms

- **Mass Change of CAD structures when changing Part structure**
 - Improved mass change Preview table showing conflicts
 - Mass WIP actions on Change tables, Folders and Search
 - Benefit: Improved user productivity for assemblies built from CAD
- **User selection of Nodes to Prune during Save-As**
 - Benefit: Better control of removing unneeded components
- **Configuration Context Enhancement**
 - Benefits: Improved Configuration Context to maintain feature consistency with Design Context.

10.2 M030

- **Excel Product Family Matrix Editor**
 - Quickly export family of related products to Excel so they can be edited together
 - *Available only with Platform Structures module*

*Current Part Number: 🔍

Current View: 🔍

Current Find Number:

Current Line Number:

Details

*Replacement Part Number: 🔍

Associated CAD Structure Action: ▼

- Build and Publish Later
- Build and Publish Now**
- Do Not Build
- Exclude from Mass Change

Comments:

	A	B	C	D	E	F
1	Define Child Parts and Add to Selected Parents					
2	*Select Parents:	<input type="text" value="GC000002"/> <input type="text" value="GC000003"/> <input type="text" value="GC000003-1"/> <input type="text" value="GC000003-2"/> <input type="text" value="GC000003-3"/>			<input type="button" value="Go to the Matrix Tab"/>	
3					<input type="button" value="Clear Table"/>	
4	*Indicates required fields				<input type="button" value="Add Child Parts"/>	
5	*Child Part Number	*Quantity	*Unit	Line Number	Find Number	
6	CP0001	1	ea		110	
7	CP0002	1	ea		120	
8	CP0003	1	ea		130	
9	CP0004	1	ea		140	
10	CP0005	2	ea		150	
11	CP0006	6	m		160	
12						

Best Practices for Managing Your Product Configurations

10.2 M030

- Providing Core BOM transformation actions:
 - Visual and HTML Browser-based environment
 - 3D integration
 - High Performance:
 - Multi-Site: 100 times
 - Action Performance: 5 to 20 times
 - Benefit: Rich set of operations to create downstream BOM to meet business requirements
- Manage mBOM related information:
 - Examples: Attribute, Documentation, Use Tabs
 - Benefits: Efficient access to details

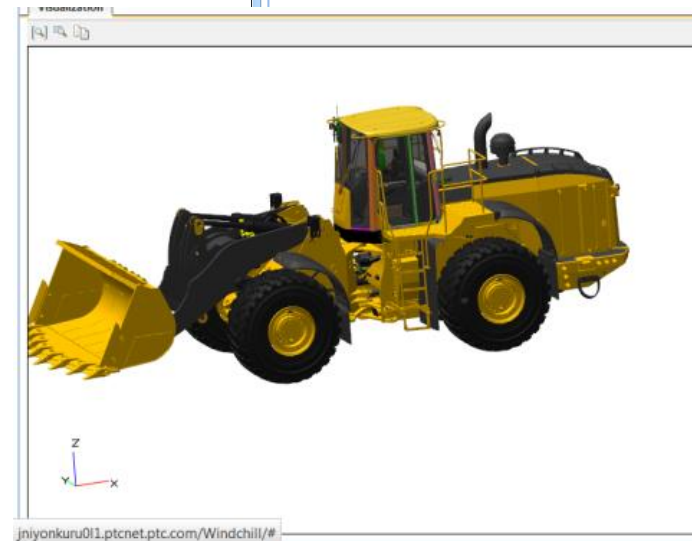
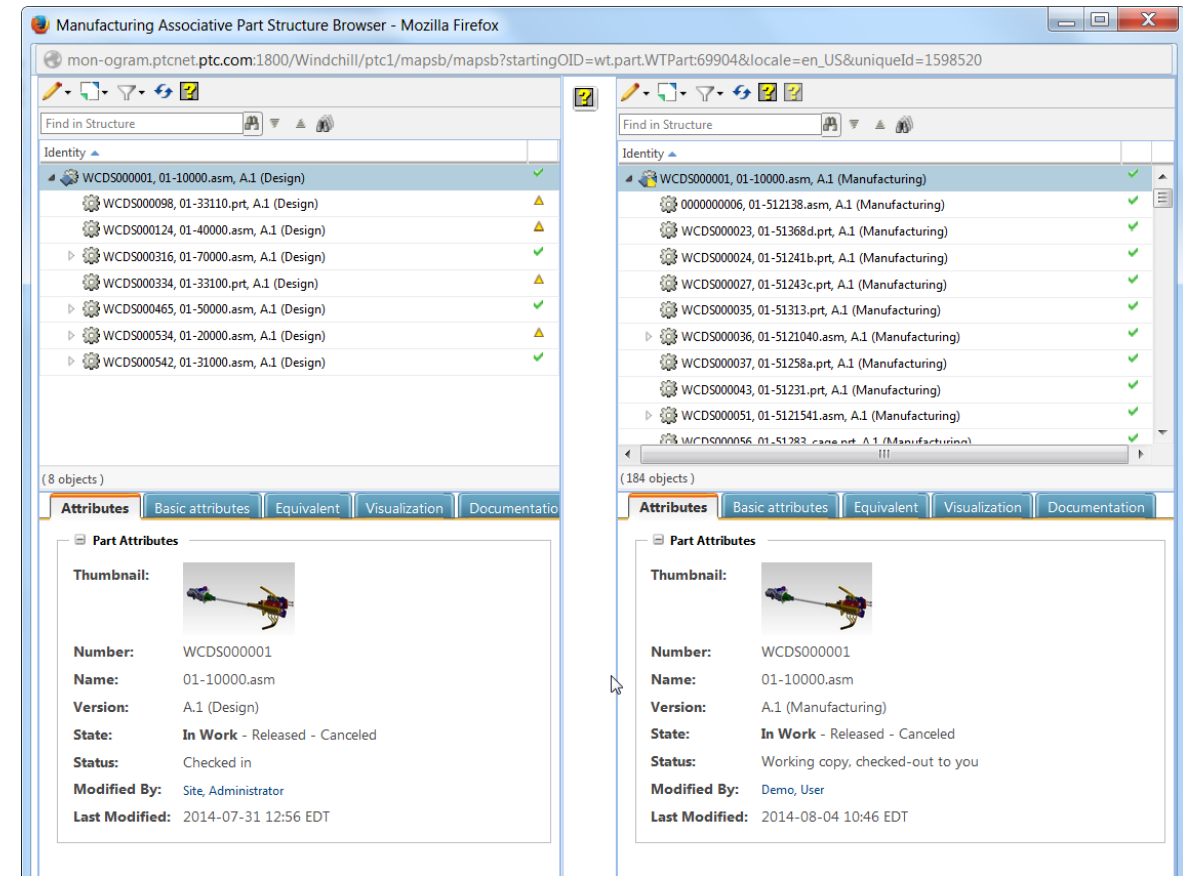

Moving to MBOM (Unifying Engineering and MFG Planning) with PTC Windchill MPMLink

- **Create a CAPA from any state of an NC, Complaint or existing non-effective CAPA**
 - Benefit: Efficiently create new CAPA as required in customer process
- **Allow a Quality Manager to Edit CAPA and NC throughout the object lifecycle**
 - Benefit: Efficiently correct minor mistakes without restarting process
- **UDI Update, and Approval Enhancements**
 - Support Update of existing UDI records from Excel
 - Support Bulk Approval of UDI Submissions
 - Benefits: Efficiently manage update and approval UDI data
- **UDI Validation Package**
 - Support FDA Requirements to validate software packages
 - Benefits: Help customers efficiently provide results and data needed to meet FDA Requirements

Corrective Action Prevention Action (CAPA)
Nonconformance (NC)
Customer Experience Management (CEM)
UDI (Unique Device Identification)

- **Flexible Links**

- Provide the ability to configure links between Change objects
 - Configure links to support customer specific change process needs
 - For Example: Link a Problem Report to a Change Notice
 - Provide constraints to enforce the use of correct types and cardinality on the links
- Benefits: Enable an organization to map their change management process needs via configuration

- **Annotation Lock Control**

- Visual and Structural annotations on a change can be locked based on customer workflow process
 - Prevent updates to an annotation being used as reference to understand the change
- Benefits: Provide clarity to the information used to assess the change

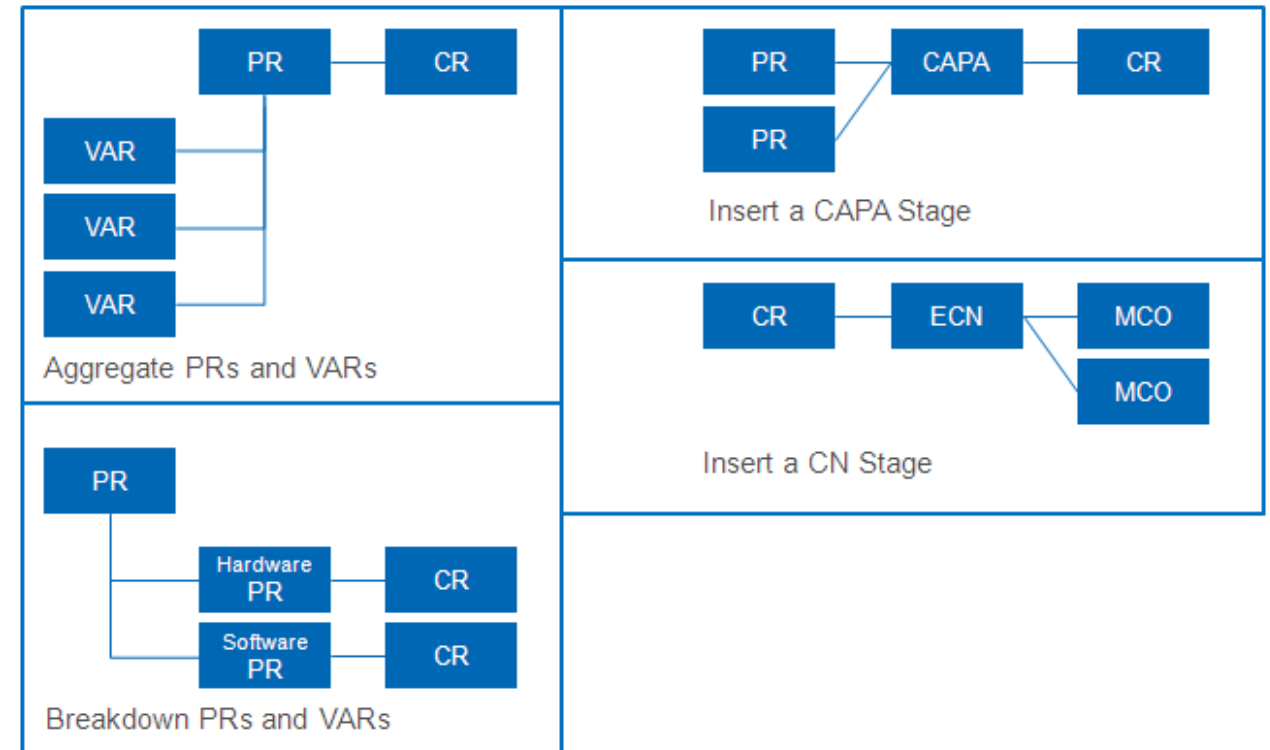

Visualization Usability

- Enable the Visualization Tab to start empty and load the representations that the user selects
 - Load or hide representations based upon selection or branch
- Thumbnails in the Attribute Tab
 - Display the thumbnail representation
- Benefits: Improve the daily experience of users working with large complex structures with better performance and the ability to just show representations they are interested in

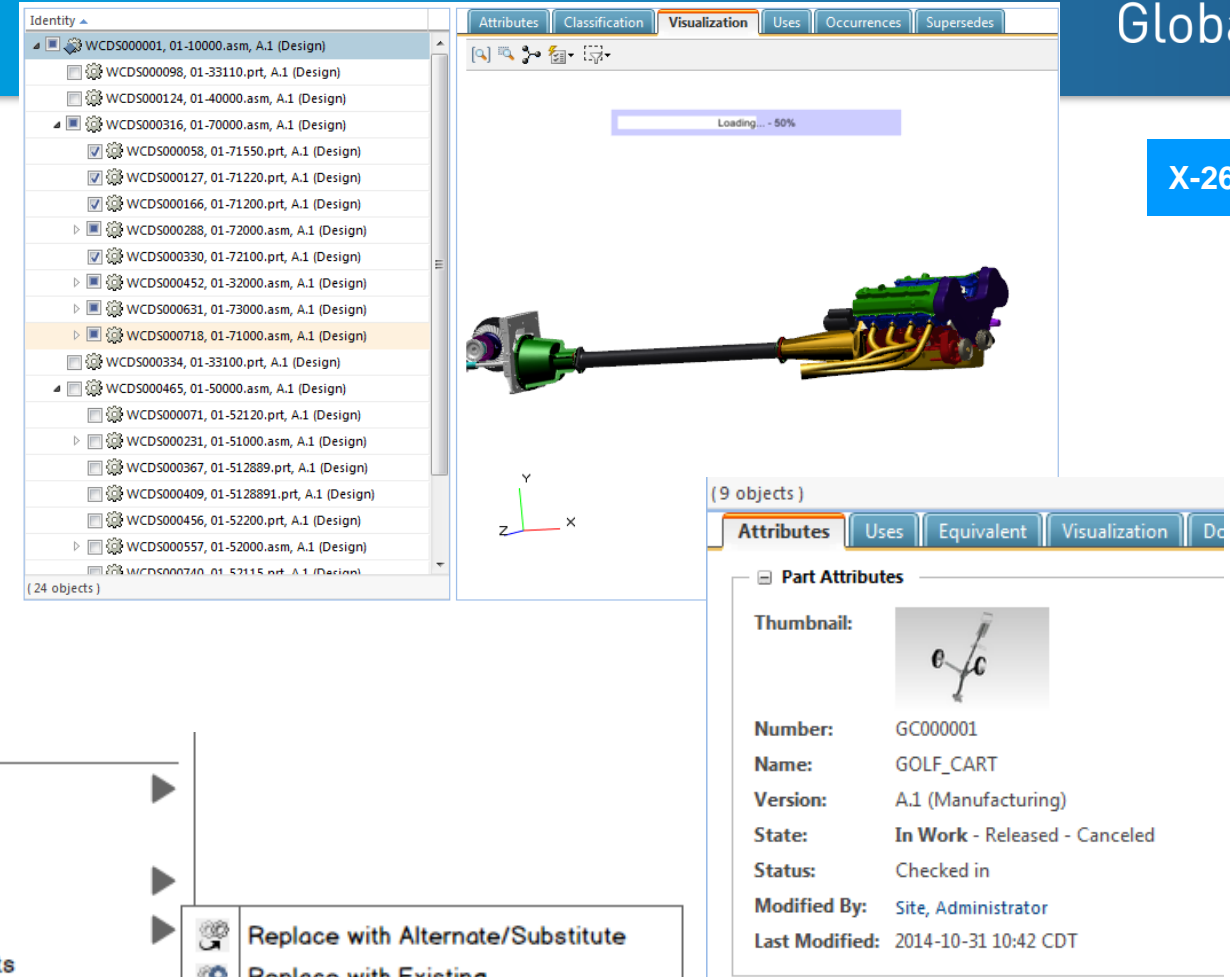

Support Replace with Existing/New in PSB

- Unify and enable all Replace actions in PSB
- Benefits: Remove need to use PSE client

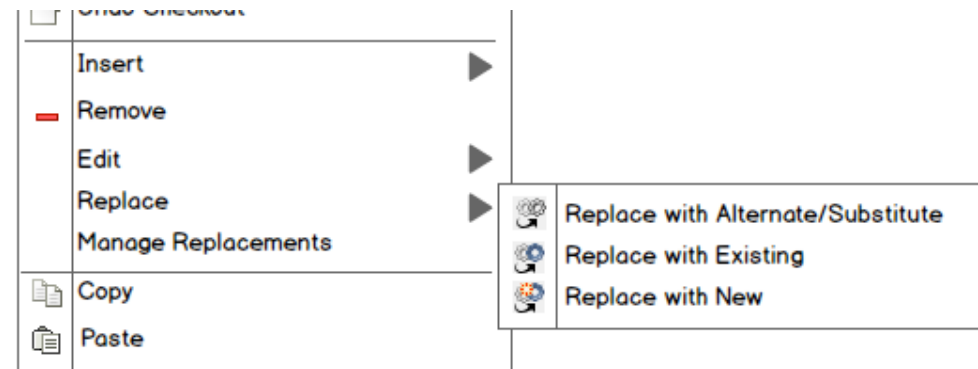

Show/Hide Usability Improvements

- Simplify steps to Show or Hide Related Information
- Provide ability for the user to define which Related Information to Show by default
- Benefits: Reduce extra steps and clutter

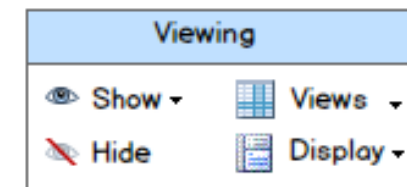

- **Naming and Numbering Improvements**

- Help users efficiently keep Part and CAD, Naming and Numbering, aligned
 - Streamline number synchronization of Part and CAD in the New Part wizard
 - Save-As, and Rename, operations will support similarly Named Parts and CAD
 - Support multiple Rename in Folders and Search Results

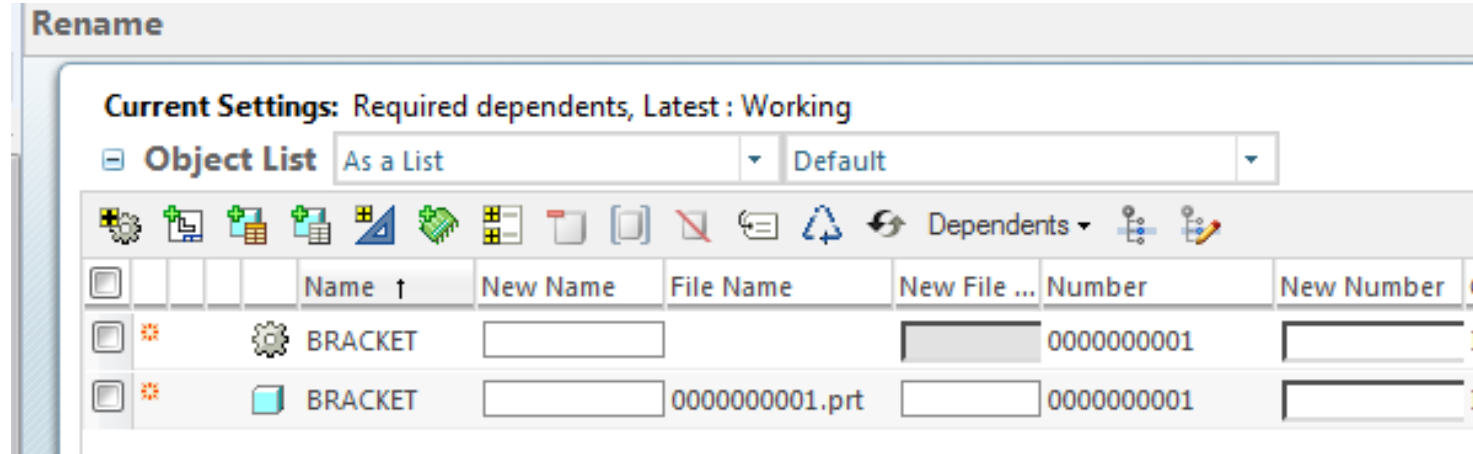

- **CAD to Part association improvements**

X-26 F000

- Streamline the association process for users
 - Improve Auto Association of Parts and CAD with the same Base Number
 - Enable Part soft type selection during CAD doc association

- **Associative Structure Build Improvements**

- Enable users to efficiently keep Part and CAD structures in sync
 - Propagating Find Number/Line Number from BOM to CAD structure
 - Enable user choice to “Build Part” on Check In

- **Managing introduction of legacy BOM with CAD**

- Allow operations (Check Out, Save As, Revise and Windchill Import) to Repair Member links with Duplicate Link IDs
- Provide a multi-object build utility to support Initial migration, and bulk loading, of Parts related to CAD

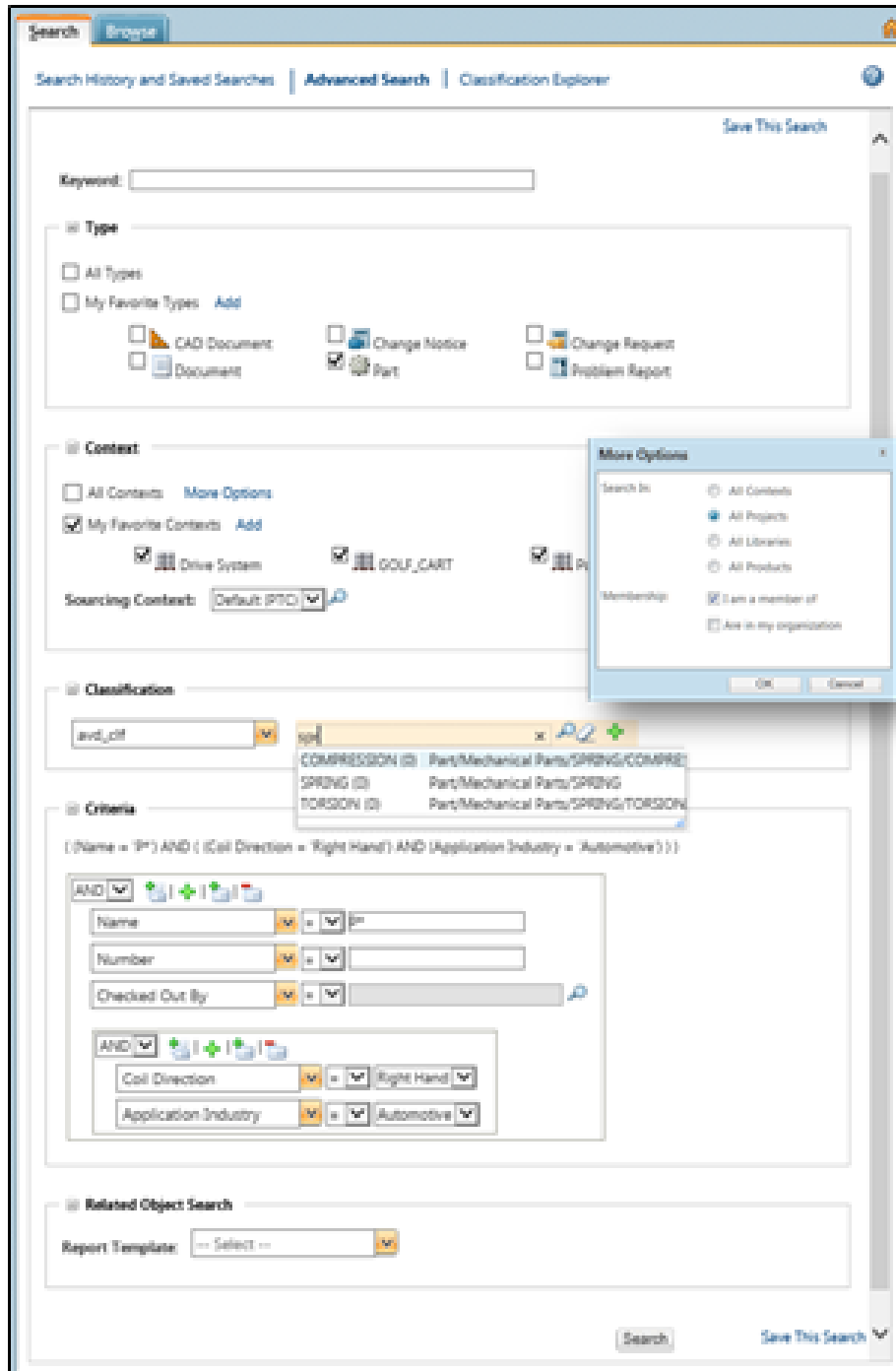

Keyword Search

Search on Content and Metadata

Type Field Set

Select Object Types

Context Field Set

Select Contexts to Search in

Classification Field Set

Select Classification(s) for Parts to Search against

Criteria Field Set

Specify criteria against classification, modeled or soft attributes

Picker for multi-valued attributes

Create complex queries with Grouping and Nesting

Relationship Field Set

Specify criteria against related objects and links

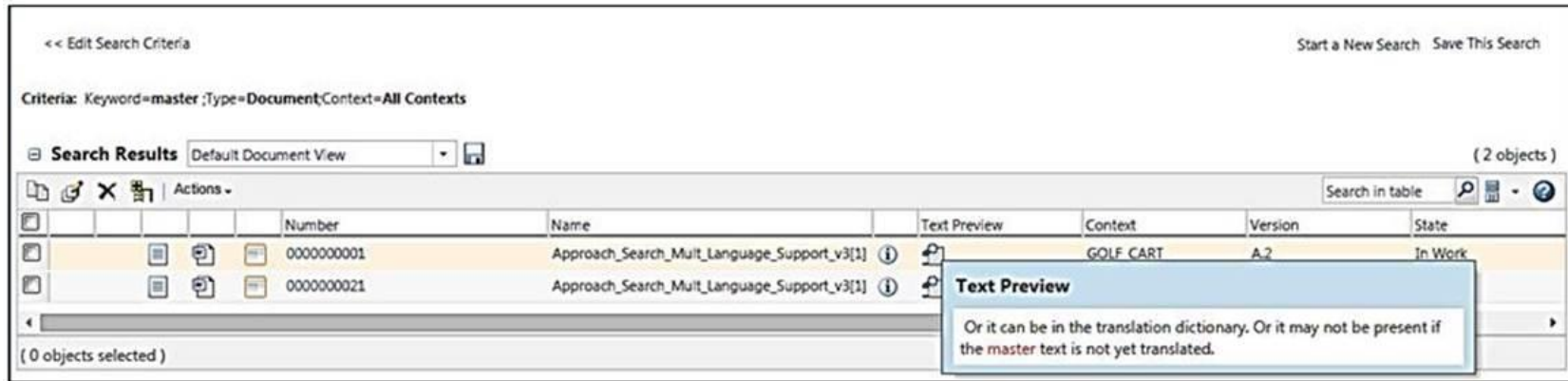

- **Keyword in Context - KWIC**

- User searched on keyword “master”
- The search results table includes documents that have the word “master” in the content of their attachments
- The text preview column on the search results table shows icons, which on mouse rollover display a sentence where the word “master” is used.

- **Dynamic Columns**

- User search criteria included both Typed Attributes (on the part) as well as Classification Attributes
- On execution, the search results table shows the attributes as columns with the values populated
- In addition, since it is a classification search, it also shows a column that reflects the complete path of the part’s classification node

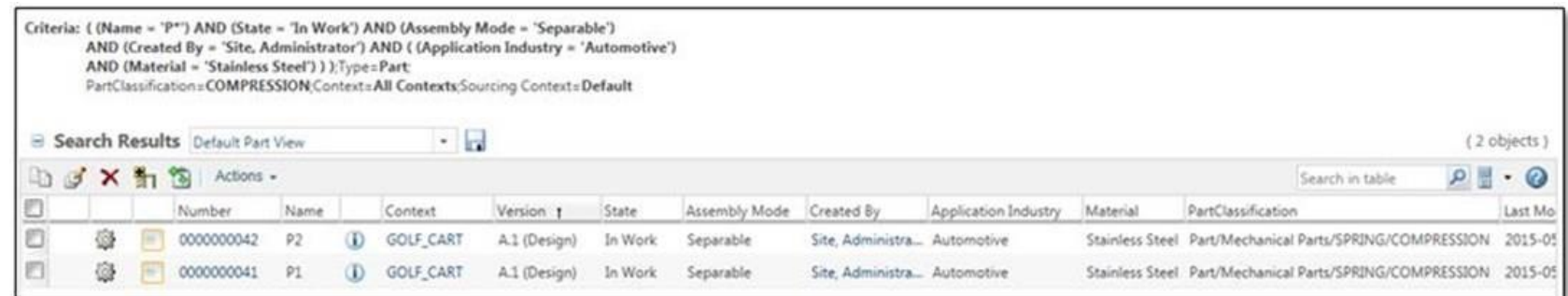

- **Faceted Search, or Navigation**
 - Common on retail shopping websites
 - Facets are explicit search dimensions, often with discrete values
 - Example: Amount of Memory on a computer: 16 GB, 32 GB, 64 GB
- **Refine Search Results**
 - Start with basic search
 - Refine results by selected discrete facet values

The screenshot shows the PTC Windchill Administrator interface. The top navigation bar includes 'Search' and 'Browse' tabs. Below the navigation bar, there are links for 'Search History and Saved Searches', 'Advanced Search', and 'Classification Explorer'. The main content area is divided into two panes. The left pane, titled 'Refine Your Results', contains several facet categories with expandable options: 'Context' (SearchTestProduct, Drive System, Power System, GOLF_CART, GENERIC_COMPUTER, Show All...), 'Created On', 'Last Modified', 'Assembly Mode', 'Configurable Module', 'Created By' (Me, Demo, User), 'Default Trace Code', 'Default Unit', 'End Item' (No, Yes), and 'Modified By'. The right pane, titled '<< Edit Search Criteria', shows the search criteria: 'Criteria: Keyword=a*;Type=Part;Context=All Contexts;Sourcing Context=Default'. Below this, there is a 'Search Results' section with a 'Default Part View' dropdown and an 'Actions' menu. A table displays the search results with columns for 'Number', 'Name', and 'Context'. The table contains 20 rows of data, including items like 'WCDS000534' (01-20000.asm) in the 'Drive System' context and 'GC000012' (LOWER_RIGHT_ACTUATOR) in the 'GOLF_CART' context. At the bottom of the table, it indicates '(0 objects selected)'.

Number	Name	Context
WCDS000534	01-20000.asm	Drive System
WCDS000562	01-51297.asm	Drive System
GC000012	LOWER_RIGHT_ACTUATOR	GOLF_CART
WCDS000391	01-51327_asm.asm	Drive System
WCDS000547	01-512106.asm	Drive System
GC000038	RT_ARM	GOLF_CART
WCDS000601	tensioner.asm	Drive System
WCDS000631	01-73000.asm	Drive System
GC000007	AXLE_LATCH	GOLF_CART
WCDS000231	01-51000.asm	Drive System
GC000004	LOWER_LEFT_ARM	GOLF_CART
GC000040	WHEEL_ASSY	GOLF_CART
WCDS000469	01-51283.asm	Drive System
WCDS000561	01-51243.asm	Drive System
GC000015	UPPER_ACTUATOR	GOLF_CART
WCDS000159	01-2_head.asm	Drive System
GC000034	AXLE_SLEEVE	GOLF_CART
WCDS000465	01-50000.asm	Drive System
WCDS000658	01-2_cam_intake.asm	Drive System

Enables customers to quickly and easily create custom connected ThingWorx applications that consume and create information in Windchill

Available now in the
ThingWorx Marketplace

Compatibility

- ThingWorx 6.0 and Windchill 10.1 M040, M050 and 10.2 M020, M030
- No extra cost for customers of Windchill and ThingWorx

Includes Support For

- Authentication through Windchill
- Native REST Services to retrieve data
- Structure Grid Widget to show CAD, Part and Document Structures
- Info*Engine task service wrappers
- Creo-View Visualization Widget

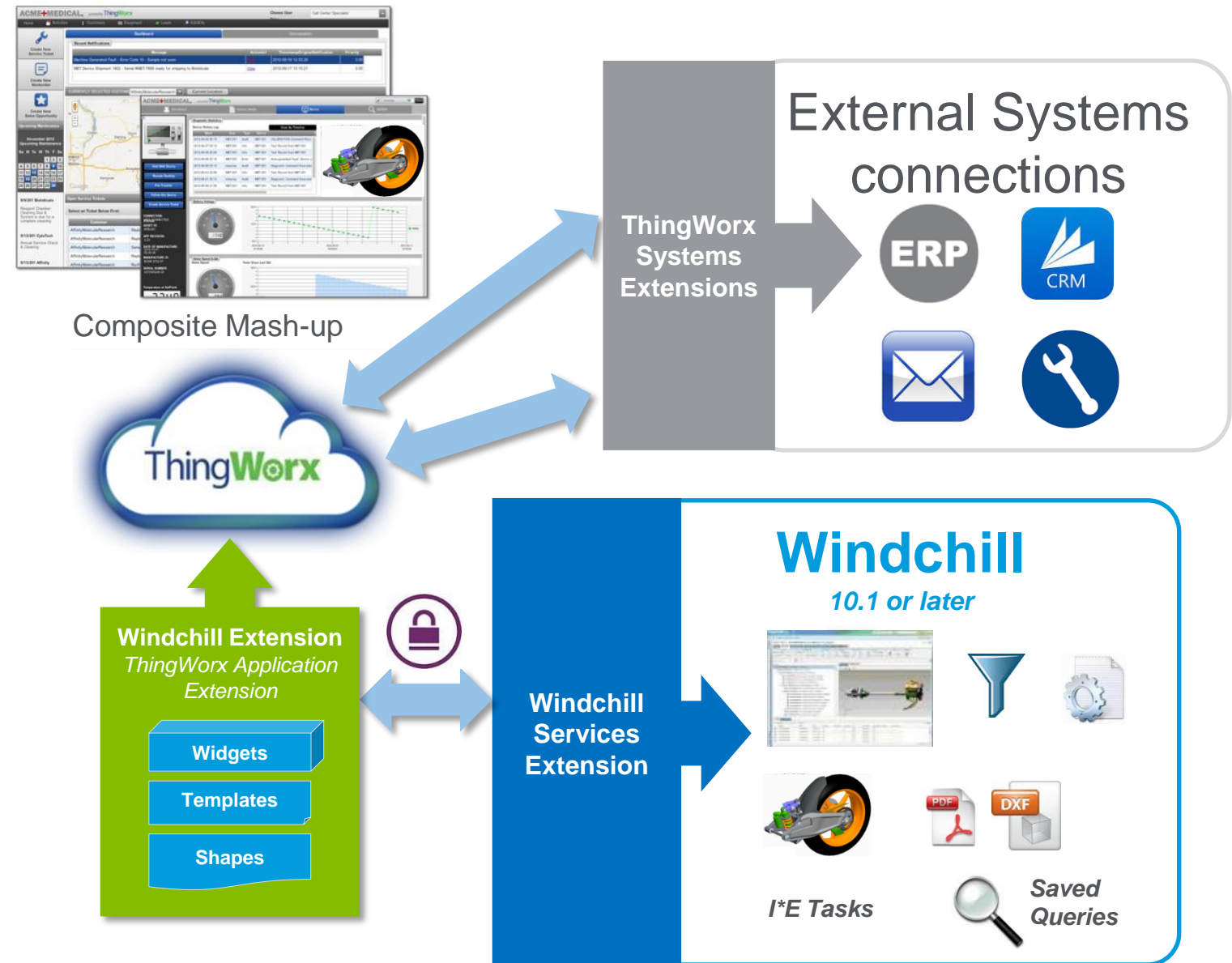

PTC Windchill Extension for ThingWorx

Sample mash up delivered with Extension

WCDS000594 Latest Load BOM

Structure

Name	Number	Version	# in Stock	\$ Cost
01-2_engine.asm	WCDS000594	A.Design	408	406.00
sqb010.prt	WCDS000352	A.Design	151	777.00
▼ tensioner.asm	WCDS000601	A.Design	712	1413.00
tensioner_guide.prt	WCDS000109	A.Design	321	308.00
tensioner_bracket.pr	WCDS000233	A.Design	723	120.00
▼ 01-2_crankshaft.asm	WCDS000204	A.Design	750	393.00
01-2_crankshaft.prt	WCDS000328	A.Design	487	1170.00
01-2_valve_timing_sj	WCDS000450	A.Design	234	361.00
▶ connecting_rod.asm	WCDS000349	A.Design	48	54.00
▶ connecting_rod.asm	WCDS000349	A.Design	48	54.00
▶ connecting_rod.asm	WCDS000349	A.Design	48	54.00
▶ connecting_rod.asm	WCDS000349	A.Design	48	54.00
▶ connecting_rod.asm	WCDS000349	A.Design	48	54.00
▶ connecting_rod.asm	WCDS000349	A.Design	48	54.00
▶ connecting_rod.asm	WCDS000349	A.Design	48	54.00
▶ connecting_rod.asm	WCDS000349	A.Design	48	54.00
▶ connecting_rod.asm	WCDS000349	A.Design	48	54.00
▶ connecting_rod.asm	WCDS000349	A.Design	48	54.00
▶ 01-2_piston.asm	WCDS000652	A.Design	700	1497.00
▶ 01-2_piston.asm	WCDS000652	A.Design	700	1497.00
▶ 01-2_piston.asm	WCDS000652	A.Design	700	1497.00
▶ 01-2_piston.asm	WCDS000652	A.Design	700	1497.00
▶ 01-2_piston.asm	WCDS000652	A.Design	700	1497.00
▶ 01-2_piston.asm	WCDS000652	A.Design	700	1497.00
▶ 01-2_piston.asm	WCDS000652	A.Design	700	1497.00
▶ 01-2_piston.asm	WCDS000652	A.Design	700	1497.00
01-2_damper_pulley	WCDS000648	A.Design	418	1348.00
01-2_crankshaft_groi	WCDS000245	A.Design	91	998.00
01-2_head.asm	WCDS000159	A.Design	648	834.00
▶ valve_exhaust_2.asm	WCDS000454	A.Design	855	452.00
▶ valve_exhaust_2.asm	WCDS000454	A.Design	855	452.00
▶ valve_exhaust_2.asm	WCDS000454	A.Design	855	452.00
▶ valve_exhaust_2.asm	WCDS000454	A.Design	855	452.00
▶ 01-2_cam_intake.asn	WCDS000658	A.Design	875	690.00
▶ 01-2_cam_exhaust.a	WCDS000494	A.Design	738	984.00
01-2_chain.prt	WCDS000646	A.Design	894	398.00
▶ 01-2_valve_intake_2.	WCDS000052	A.Design	280	570.00
▶ 01-2_valve_intake_2.	WCDS000052	A.Design	280	570.00
▶ 01-2_valve_intake_2.	WCDS000052	A.Design	280	570.00
▶ 01-2_valve_intake_2.	WCDS000052	A.Design	280	570.00
01-2_front_oil_seal.p	WCDS000298	A.Design	676	503.00

Export BOM CSV

Properties

parentId	/
objectId	OR:wt.part.WTPart:64725
name	01-2_head.asm
usesOccurrenceIdentifier	110.0
defaultUnit	ea
view	Design
type	Part
version	A.Design
number	WCDS000159

2D

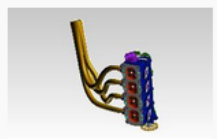

Export Properties CSV

Create Problem Report

3D

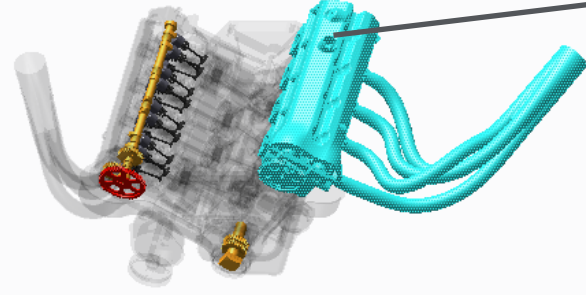

Additional Files

Open in Creo View

Obtain and display BOM Structure using navigation criteria

Create mashup with columns using data for part items obtained from other systems

Bi-directionally navigate through 3-D view and/or BOM Structure

Obtain properties based on structure or visual selection

Create Windchill objects such as a problem report using Info*Engine tasks

Download published representations such as PDF, IGES or STL

Use the 3-D visualization widget to manipulate and facilitate decision making based on color coding driven by attribute values from Windchill and external systems

Launch in Creo View to measure, explode, and section

- Your feedback is valuable
- Don't miss out on the chance to provide your feedback
- Gain a chance to win an instant prize!
- Complete your session evaluation now

PLM Sessions (not a complete list)

Topic	Date	Time	Room	Topic	Date	Time	Room
PTC Windchill Business and System Administration Roadmap	6/8/2015	1:15PM	Lincoln C	Smart, Connected Products Need Electronics: How to Manage Them with PTC Windchill	6/9/2015	1:15PM	Jackson AB
PTC PLM Cloud: Fueling Business Agility and Reducing Costs	6/8/2015	1:15PM	Hermitage AB	Managing the SKU Development Process for Consumer Products	6/9/2015	2:15PM	Lincoln DE
Consolidating Multiple CAPA Systems: The Case for Quality Management in PLM	6/8/2015	2:15PM	Hermitage D	Improving PTC Windchill Performance	6/9/2015	4:00PM	Jackson AB
Best Practices for Managing Your Product Configurations	6/8/2015	2:15PM	Lincoln DE	Driving Part Re-Use: ROI and Best Practices for Maximize Design Reuse	6/9/2015	5:00PM	Jackson AB
Process Planning Management with PTC Windchill MPMLink	6/8/2015	2:15PM	Hermitage AB	Moving from PDM to PLM: The Value of Associative BOM	6/10/2015	8:15AM	Hermitage D
Part Types in PTC Windchill	6/8/2015	4:00PM	Lincoln DE	Smart, Connected Products and PLM: The Future is Here	6/10/2015	9:15AM	Tennessee B
Unified Search in PTC Windchill	6/8/2015	5:00PM	Hermitage AB	Moving to MBOM (Unifying Engineering and MFG Planning) with PTC Windchill MPMLink	6/10/2015	10:30AM	Jackson AB
Model Based Design: 3D Product Development for a 3D World	6/8/2015	4:00PM	Hermitage AB	Connecting PLM to PTC: Improving Support and Maintenance	6/10/2015	10:30AM	Hermitage D
Managing Configurable Product Platforms	6/9/2015	10:00AM	Presidential Boardroom A	PTC Role-Based Applications	6/10/2015	11:30AM	Washington B
Change Management Best Practices: Executing the Change Process	6/9/2015	10:00AM	Jackson AB	PTC's Own Smart Connected Applications	6/10/2015	11:30AM	Jackson EF
Leveraging PTC Creo Unite in a Data				Monitoring PTC Windchill through PTC System Monitor and User Experience			

PTC[®] Live Global

- **Support Promotion Request on Check-In**
 - Provide the ability to create a Promotion Request during Check-In
 - Benefits: Simplify the process to create Promotion Requests by reducing additional steps
- **Promotion Request enhancements**
 - Comment rows for each item in the Promotion Table
 - Incorporate Native Task Template in the OOTB Promotion Request Workflows
 - Define a Need Date for the Promotion Request
 - Broaden Business Rule support for Promotion Request
 - Leverage “Checked Out” Business Rule check in Promotion Request workflows
 - Support for Attribute Business Rules with Promotion Requests

Target Promotion State: Released X-26 F000

Promotion Objects All

Number ↑	Version	Name	State	Promotion Comments	Available S
01-2_CAM_EXHAUST.ASM	A.1	01-2_cam_exhaust.asm	In Work	Update CAM assembly	Canceled
01-2_CAM_EXHAUST.PRT	A.1	01-2_cam_exhaust.prt	In Work	Refine CAM profile per new lab results	Canceled
WCDS000494	A.1 (Design)	01-2_cam_exhaust.asm	In Work	Update CAM assembly	Canceled
WCDS000666	A.1 (Design)	01-2_cam_exhaust.prt	In Work	Refine cam profile per lab test results from exhaust gas analysis and next gen EPA Tier 2 testing	Canceled

(0 objects selected)

Task - 01-51328_outer_race.prt, WCDS000100, A.1, 2015-05-051430833748705-Approve Pr

Details Promotion Objects

Promotion Objects Promotion Objects

Promote Status	Number ↑	Version	Name	Promote...	Promotion Comments	Context
	WCDS000033	A.1 (Design)	01-2_valve_shim.prt	In Work	Work is complete let...	Drive System
	WCDS000098	A.1 (Design)	01-33110.prt	In Work	Please review updat...	Drive System
	WCDS000100	A.1 (Design)	01-51328_outer_race.prt	In Work	Check race clearances	Drive System
	WCDS000226	A.1 (Design)	01-51282a.prt	In Work		Drive System

(0 objects selected)

10.2 M030

- Providing Core BOM transformation actions:
 - Visual and HTML Browser-based environment
 - 3D integration
 - High Performance:
 - Multi-Site: 100 times
 - Action Performance: 5 to 20 times
 - Benefit: Rich set of operations to create downstream BOM to meet business requirements
- Manage mBOM related information:
 - Examples: Attribute, Documentation, Use Tabs
 - Benefits: Efficient access to details
- Manage Equivalent Part Link
 - Occurrence Link X-26 F000

