

SCALEXTRIC
4SCHOOLS



Scalextric4Schools

PTC® | ACADEMIC
PROGRAM

C2-ED-L2-004-1.0

Written by
Tim Brotherhood

These materials are © 2012, Parametric Technology Corporation (PTC)
All rights reserved under copyright laws of the United Kingdom, United States
and other countries.

PTC, the PTC Logo, Creo, Creo Parametric, Creo Elements/Pro, Wildfire,
Windchill, Pro|DESKTOP and all PTC product names and logos are
trademarks or registered trademarks of PTC and/or its subsidiaries in the
United States and in other countries.

Conditions of use

Copying and use of these materials is authorized only in the schools colleges
and universities of teachers who are authorised to teach Creo Parametric in
the classroom.

All other use is prohibited unless written permission is obtained from the
copyright holder.

Acknowledgements

Initial idea and ongoing development - Chris Jarman & David Eyre.
PTC – Ayora Berry, Mike Brown, Phil Darlington, Andy Deighton, Mark
Fischer, Alister Fraser, Adam Haas, Tom Malloy, Curtis Siebenaller,
Hornby – Paul Chandler, Tom Malloy, Adrian Norman, Victoria Reed, Darren
Rye.
Boxford – Howard Barrett, Paul Barraclough, Gary Smith, Dave Porter, Pete
Olive.
CR Clarke – Maurice Clarke.
Bits from Bytes – Iain Major, Andrew Edwards.
Concept2Creation – Bernie Fitzsimmons, Andrew Lloyd, Ron Stevens.
Data Harvest – Barbara Higginbottom.
Dimension 3D Printing – Paul Gateley.
Pilot – Wolgarston High School, Alleyne’s High School, Dave White -
Clevedon School.
RolandDG – Russell Cooper, Glenn Kennedy, Andrew Dudley, Peter, Kettle.

Feedback

In order to ensure these materials are of the highest quality, users are asked
to report errors to the author.

tbrotherhood@ptc.com

Suggestions for improvements and other activities would also be very
welcome.

Product code

C2-ED-L2-004-1.0

The following organizations share a common goal of promoting STEM subjects and
endorse PTC’s Education Program.

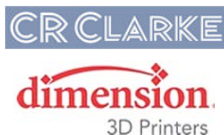

Contents

Contents	2
Session one: Scalextric4Schools Challenge	5
Overview	7
Task1: Configuring Creo Parametric	9
Task 2: Download the model files	9
Task 3: Setting the working directory	10
Task 4: Exploring Creo Parametric.....	12
Task 5: Prepare for modeling	15
Task 6: Body profile.....	17
Task 7: Side taper	25
Task 8: Rounds	29
Task 9: Complete the mold	31
Task 10: Model properties.....	33
Task 11: STL file for machining.....	35
Session two: Physics of car performance	37
Task 1: Review homework.	37
Task 2: Review design factors	37
Session three: Modify Creo Parametric models.....	38
Task 1: Hornby the company	38
Task 2: Dealing with failed features	38
Task 3: Reverting to a previous version of a part	41
Extension one: Alternative modeling strategies	42
Freestyle	Error! Bookmark not defined.
Creo Direct.....	Error! Bookmark not defined.
Blend.....	42
Variable section sweep	42
Warp.....	42
Session four: Own design	43
Task 1: Preparing your drawings.....	43
Task 2: Tracing over Images.....	44
Session five: Machining	47
Session six: Car assembly.....	49
Session seven: Testing, analysis and simulation.....	50
Task 1: Mass/C of G measurement.....	51

Task 2: Frontal area	53
Task 3: Center of gravity and stability	55
Task 4: Acceleration.....	58
Task 5: Coefficient of friction	59
Session eight: Presentation preparation	62
Task 1: CAD modeling the vacuum formed body	63
Task 2: Part properties.....	68
Task 3: Add body shell to the assembly	70
Session nine: Visualizing	74
Task 1: Applying textures	75
Task 2: Sponsorship and logos	77
Task 3: Applying a decal	80
Task 4: Final render	84
Session ten: Races.....	88
Session eleven: Presentation	89
Appendix: Car design template.....	90

Session one: Scalextric4Schools Challenge

Scalextric4Schools is an exciting Design – Make – Race challenge developed by PTC™ and Hornby™ with support from Root Solutions™. Many companies and organizations support the challenge.

Full information including guides, rules and links to order components and track can be downloaded from www.scalextric4schools.org

Introduction

The PTC Scalextric4Schools challenge provides students with **Creo Parametric 3D** software to model their own designs for 1:32 scale racing cars. Many schools will have equipment to manufacture their cars but if not, partner schools and organizations will manufacture components and ship to the team. Details are on the web site at www.scalextric4schools.org.

A combination of track testing and simulation using the advanced tools in **Creo Parametric** will help you understand the physics of car performance and redesign your car to make it faster.

In certain regions, PTC organizes official competitions where teams compete to become champions.

Prior learning

This tutorial assumes you are already familiar with **Creo Parametric** and comfortable creating parts, assemblies and testing movement using kinematic motion.

If you are not confident about these techniques you should complete the Primer and Advanced Primer. These can be downloaded here: www.ptcschools.com.

To help you get the most from **Creo Parametric**, PTC provides teachers and students with access to Precision LMS, a virtual learning environment with over 400 hours of self-paced tutorials covering all of the tools and techniques available in **Creo Parametric**.

The slot car challenge was originally developed by design & technology teachers David Eyre and Chris Jarman. The cars you see on the right and on the next page were created by them and their students.





Scale models

Most slot cars are designed to a scale of 1:32 which means the model of a car 12 feet (4 metres) long in real life will be 4.5 inches (12.5 cm) long.

The Design guide booklet shows how to transfer your own sketches into **Creo Parametric** and trace around them to create the shape of your very own slot car.

The design challenge

Can you design and make a slot car based around a standard chassis?

Models should be to a scale of 1:32 and must comply with the rules for the competition.

This tutorial and companion documents will prepare you for the challenge.

After designing and making your car you can test it on any analogue Scalextric track.

Schools can buy sets of parts and a special track layout for this challenge at heavily discounted prices. Details on: www.scalextric4schools.org

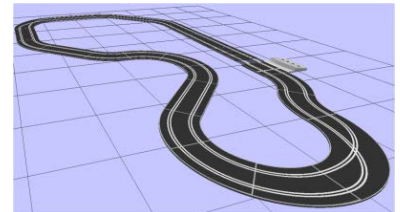

Baseline for car performance

An important part of design development is to establish a 'benchmark' against which you can measure how quick your design is.

With help from your teacher, you will be shown how to model, make, assemble, set-up and test a standard car shape to establish a benchmark for future design improvement.

The 'Make – Assemble - Setup' booklet will help you get the car working smoothly and efficiently.

You should then use scientific methods to carry out 'fair tests' to quantify the performance of the standard car, establishing the benchmark.

Later you will carry out the same experiments on your own designs to measure any improvements in performance.

Overview

Chassis

This inline chassis layout is used for the **Creo Parametric** tutorial that follows. A number of flat parts are slotted together and a single screw holds everything together.

This allows components to be swapped and changes to be made very easily.

Design for maintenance is very important part of product development.

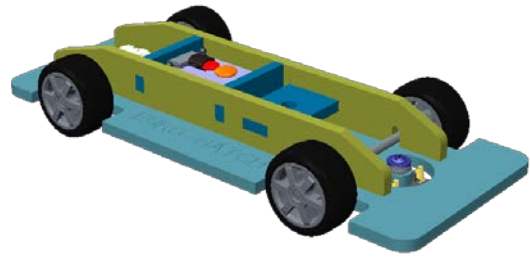

Body

High quality realistic body shapes are made possible using CNC machining to create a mold.

The mold can then be used to vacuum form thin shells from thermoplastic sheet.

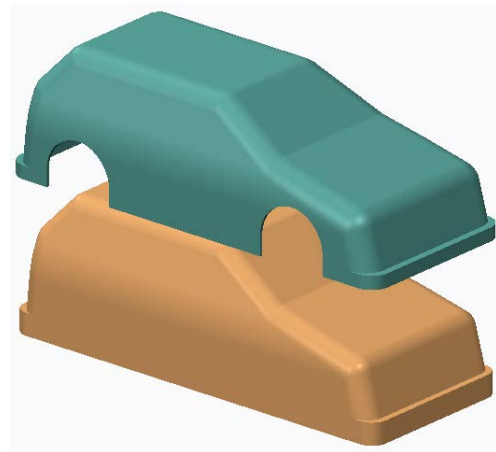

Outline

The instructions that follow will teach you how to use **Creo Parametric** to create a hatchback body shape for a slot car.



The starting point is a **Creo Parametric** part with half the base modeled and wheel arch cutouts.

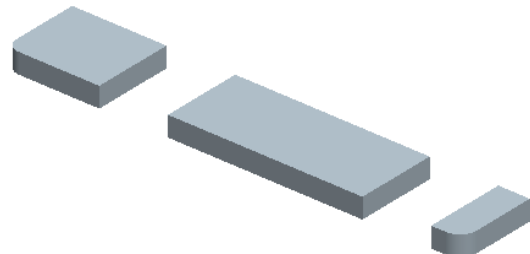

You will insert a series of features that form the body mold which is then exported for manufacture.

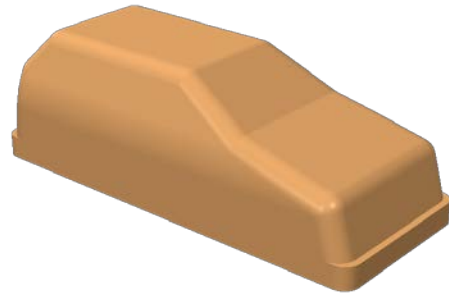

Additional features will be added to convert the mold into a finished car body.

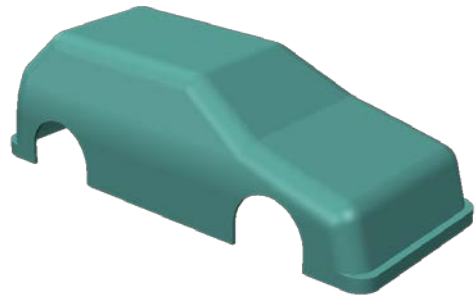

With symmetrical designs it's good practice to model half of the car body and mirror the shape late in the modeling process. Any asymmetric details like driver, steering wheel, windshield wipers and exhaust pipes can be added after the mirror feature.

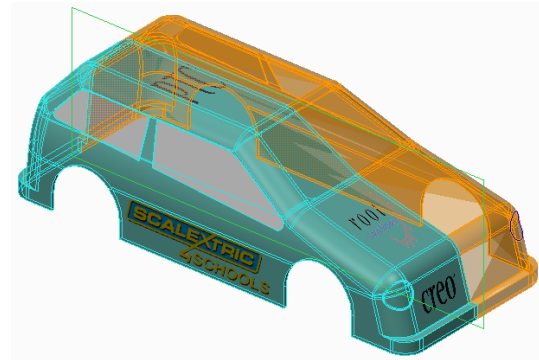

Task1: Configuring Creo Parametric

Expert/overview

PTC provides scripts to configure Creo Parametric for units of measurement and drawing standards. Refer to the install instructions to configure Creo Parametric for **mm, kg and seconds**.

Task 2: Download the model files

Expert/overview

We provide models you can download to use as a starting point

1. Go to www.scalextric4schools.org:
 - On the right of the home page click **Get Started**:
2. Expand the Download Curriculum and CAD Models section:
 - Click on F3 Hatchback Creo Parametric 2.0:
 - **Save** the file where you store documents:
 - Right click on the zipped folder and select **Extract All**.



There may be occasions when it would be useful to see a completed version of an exercise. We provide completed versions of most activities by adding a Z_ prefix to the filename. These files appear at the bottom of a list of files sorted alphabetically.

For example, the completed body mold exercise is named Z_BODY.PRT

Task 3: Setting the working directory

Expert/overview

When modeling using **Creo Parametric** you will create many different files in numerous formats and there will be occasions when **Creo Parametric** creates files for you. It is important that all these files can be found later and the easiest way to ensure this is to set the working directory before you start modeling.



Always **Set working directory** before you start each **Creo Parametric** modeling session.

1. Getting started:

- Start **Creo Parametric**.
- From the **Home** tab, **Data** group, click **Select Working**

Directory

- In the Select Working Directory dialog box navigate to the folder **2013_S4S_Car** folder.
- Click **OK** to set the folder as the working directory.

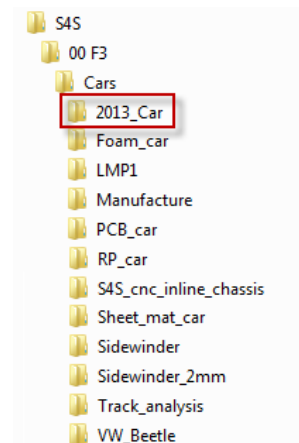

2. Open an assembly

- From the Quick Access toolbar or the Home tab, click **Open**
- In the File Open dialog box, double click **2013_S4S_HATCH.ASM**

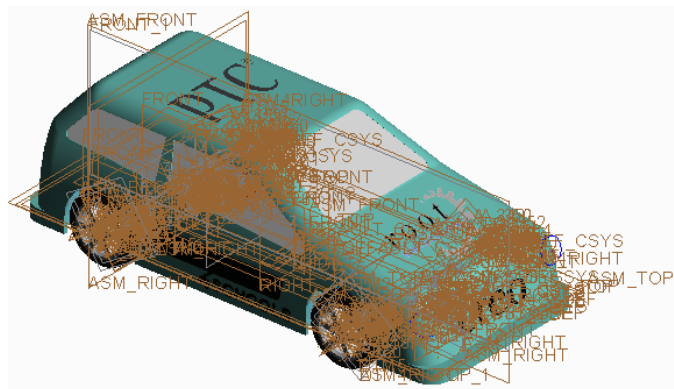

You will see a completed Scalextric4Schools car in the graphics screen.

3. Hide datum features

- From the In Graphics toolbar, click the **Datum Display Filters**  list and disable the display of all datum features.

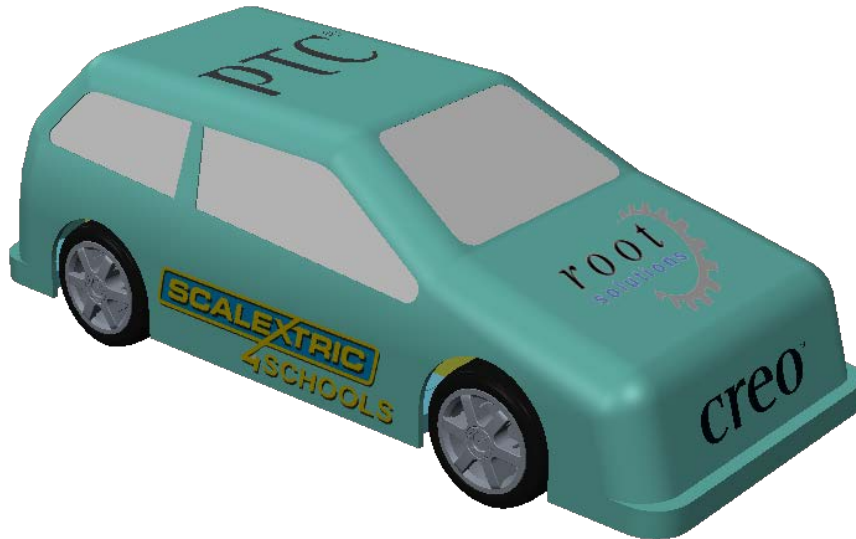
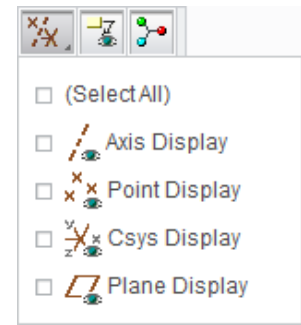

What have you learned?

- Overview of the Scalextric4Schools F3 car.
- Aware of Creo modeling the car body.
- Configure Creo for units of measurement.
- Download library files.
- Setting working directory.
- Open files.
- Datum visibility.
- Advantages of mirroring geometry.
- Multiple select (Ctrl key to add/remove selections).
- Edge references.

Task 4: Exploring Creo Parametric

Expert/overview

This section will show or remind you how to manipulate and position models in the graphics area. You will also hide and unhide components in the assembly.

1. Spinning the model

- Move the mouse cursor into the graphics area, hold down the middle mouse button and move the mouse.
- As you move the mouse, the model will spin around the **Spin Center** .



If the Spin Center is turned off, the model spins around the mouse cursor position.

2. Zoom the model

- Move the mouse cursor over a part of the model and, without clicking, rotate the middle mouse wheel.

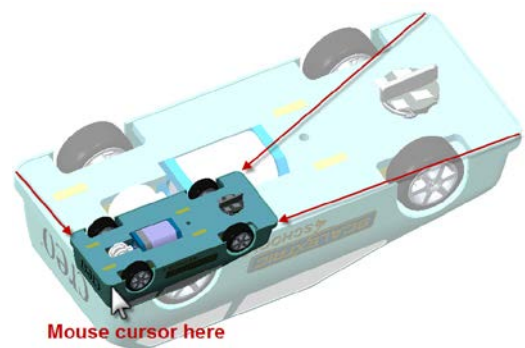

The zoom function uses the mouse cursor as the fixed position while zooming.

3. Refit the model

- If the model disappears, there is a button to refit the model in the modeling window.
- From the In Graphics toolbar, click on **Refit** .

The model will automatically zoom to fit into the graphics area.

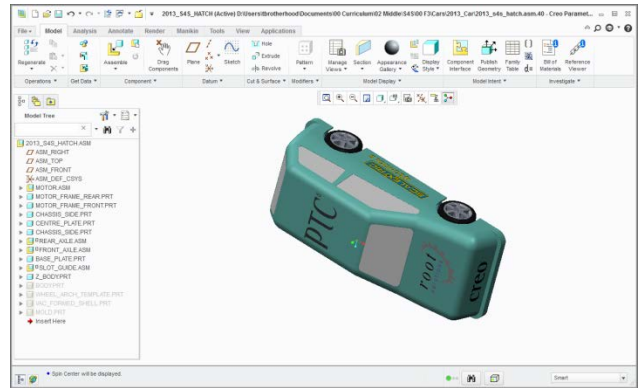

4. Saved Views

You may also want to return to a view of the car the correct way up.

- From the In Graphics toolbar, click **Named Views**  and select **Trimetric** from the drop-down menu.



5. Hiding and Unhiding

- In the model tree, right click on **Z_BODY.PRT**, and from the pop-up menu, select **Hide**.

The body will disappear.

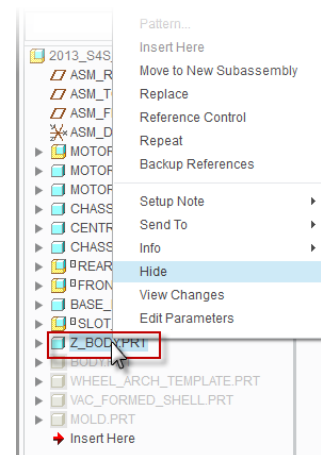
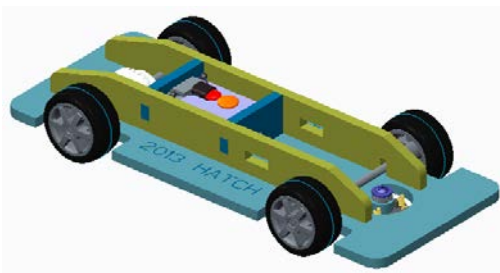

- In the model tree, right click on **BODY.PRT** and from the pop-up menu select **Unhide**.

This part will be developed first as a mold and then as the finished body.

At the moment BODY.PRT occupies the same space as the chassis base and is shown here highlighted in green.

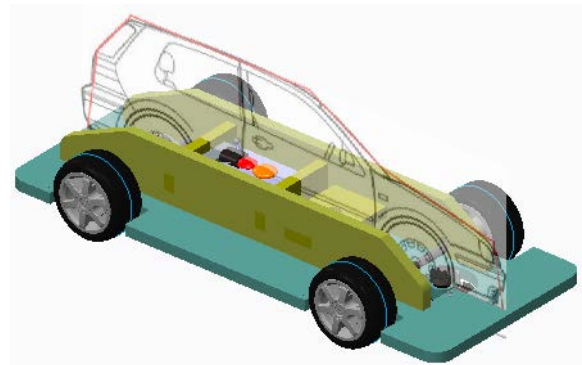



Along the centerline of the car you will see a drawing for a hatchback car. This will be used as a guide when drawing the side profile of the car. Later in this tutorial you will be shown how to add your own design sketches to the model.

Task 5: Prepare for modeling

Expert/overview

You will open the file BODY.PRT, move the Insert Here flag then add features to create the mold shape.

1. Opening a part from an assembly

- In the model tree right click on **BODY.PRT** and from the pop-up menu, select **Open**.

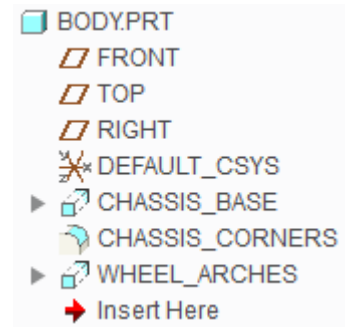
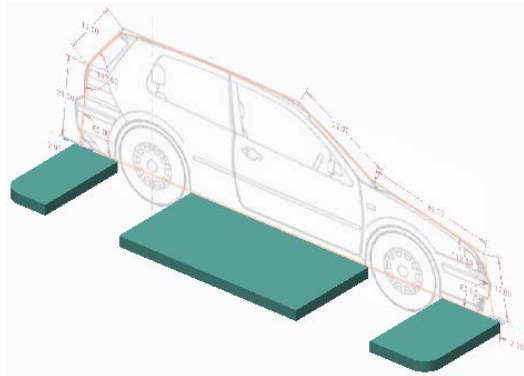

The model tree displays the features that were used to create the part.

Several new features need to be inserted before the CHASSIS CORNERS feature.

2. Inserting new features

- In the model tree, drag the **→Insert Here** flag above the **CHASSIS_CORNERS** feature.

The model tree will look like this with the wheel arch cut outs and corner rounds disappearing from the model.

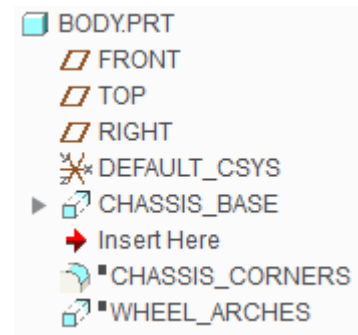
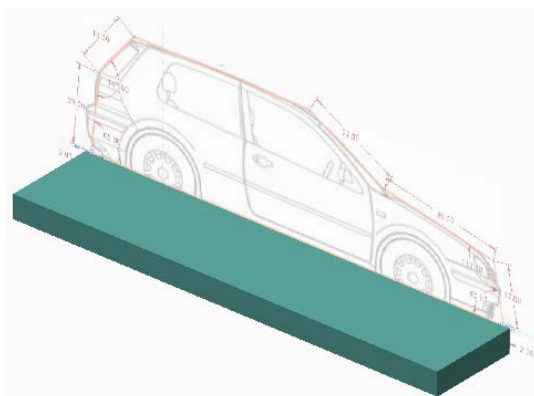

The small black squares next to the features below the red arrow in the model tree indicate the features are now 'suppressed' and not being included in the model.

What have you learned?

- Viewing the model – Rotate, zoom and spin center.
- Hide and unhide parts in the model tree.
- Inserting features in the model tree.

Task 6: Body profile

Expert/overview

The body profile shown below will be extruded from an internal sketch located on the **FRONT** datum plane.

The sketched profile uses straight lines to trace the car outline and references the **TOP** datum plane and the ends of the **CHASSIS_BASE** extrusion.

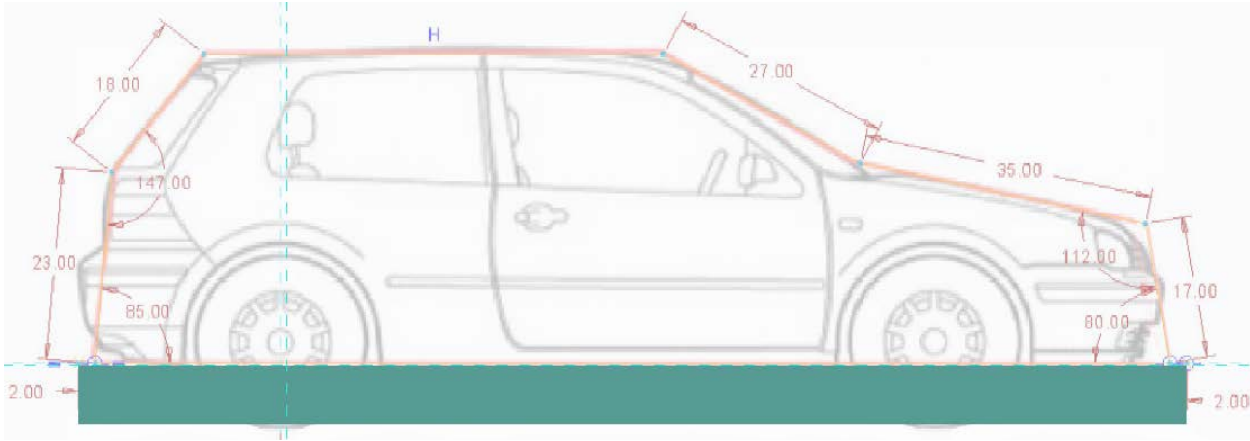

1. Begin extrusion

You will start an extrusion and then select the **FRONT** datum plane as your sketching plane.

- From the **Model** tab, **Shapes** group, click **Extrude** .

The Extrusion dashboard will appear across the top of the modeling window.

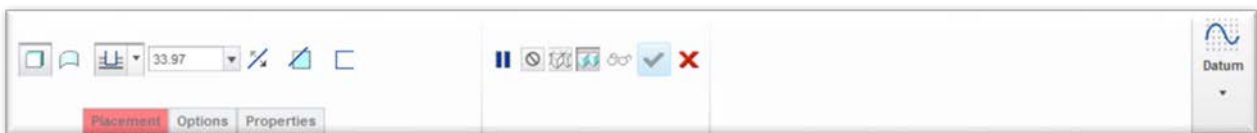

- In the model tree, select the **FRONT** datum plane as the location for the sketch.

The Sketch tab will open across the top of the **Creo Parametric** screen.

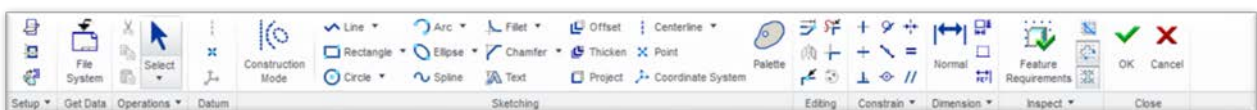

- From the In Graphics toolbar click **Sketch View** .



To help with the next step we have provided red lines you can trace over plus dimensions if you want to fully constrain the sketch.

2. Sketching the body profile

- In the Sketcher toolbar start the Line Chain  tool.
- Draw the shape shown here by left clicking at each **X** starting with number one and finishing back at the same point. When drawing the roof line, make sure there is an 'H' visible showing this line will be constrained to be horizontal.

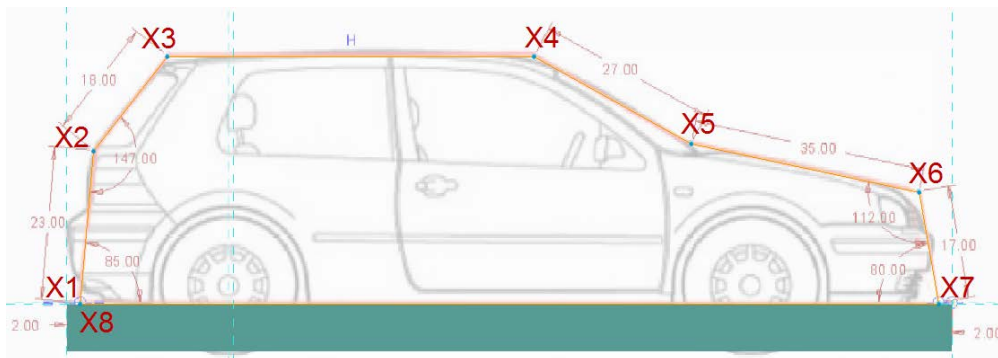

- When you finish drawing the shape, click the middle mouse button twice to complete the sketch.



Initially your sketch should look like this with dimensional constraints. **Creo Parametric** has added these grey 'weak' dimensions. Don't worry if yours are not the same as these at the moment.

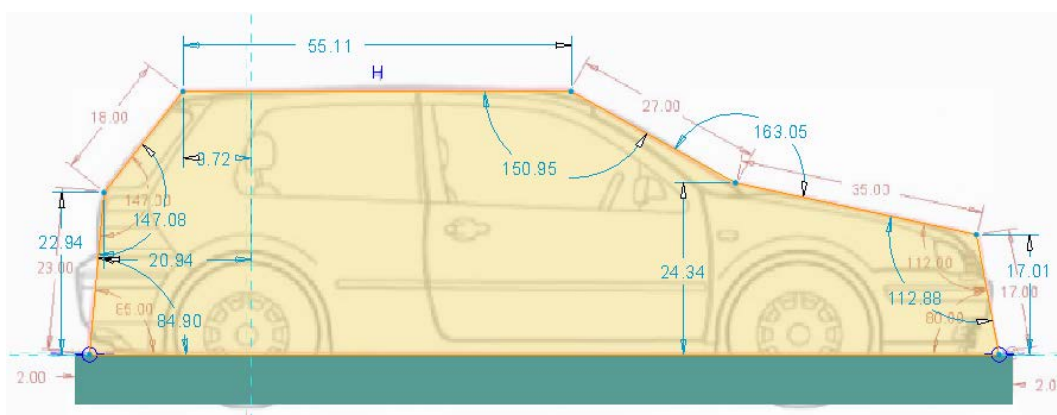

The sketch for a simple extrusion should contain a continuous outline with no breaks or overlaps. If the sketch is a closed loop, **Creo Parametric** will shade the outline as shown in the previous illustration.

Sketch diagnostics

If your sketch is not shaded, **Creo Parametric** provides diagnostic tools in the **Inspect** group of the Sketcher toolbar to help find errors.

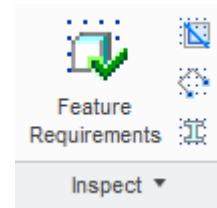



Cause

- Profile not shaded
- Open ends
- Gaps - Lines that do not meet properly
- Coincident lines - Lines drawn on top of each other

Cure

The **Highlight Closed Loops** tool should be active by default and shades closed outlines of lines. If an outline will not shade, use the other diagnostic tools to find and correct errors.

Use the **Highlight Open Ends**  diagnostic tool to find these, the open end will have a red dot clearly visible.

The **Highlight Open Ends** tool  will also identify very small gaps with two red dots close together. Zoom in on each pair of red dots to find the gap, delete the line that is too short and redraw it closing the gap.

Use the **Overlapping Geometry** tool  to find overlapping lines. The double line and the line either side will be highlighted in **red**. Click on the middle one of the **red** lines and delete it.

Repeat the  diagnostic tool as many times as necessary to find each duplicate line.

If you accidentally delete a line that is not a duplicate, use **Undo**  or **Ctrl + Z** to restore the last line deleted.

- Extended lines
- Stray lines

Use the **Highlight Open Ends** tool  to find extended lines.

Zoom in on each extended line and use the trim tool  to delete the extended part of the line.

The **Highlight Open Ends**  diagnostic tool will help you find these. Look inside and outside the profile for red dots and delete the stray lines.

If these techniques do not work use **Undo**  or **Ctrl + Z** multiple times to remove all lines and sketch the profile again.

Revising the dimensioning scheme

There are 3 types of sketch dimension;

- **Weak** - colored **light blue**, these are created automatically by **Creo Parametric**. They report sizes in the sketch but allow changes to be made including letting you drag lines and points.

- **Strong** – these dimensions are **darker blue** in color. Geometry controlled by strong dimensions can still be dragged on screen.
- **Locked** – these dimensions are **brown** in color. Geometry controlled by locked dimensions cannot be changed by dragging on screen. Locked dimension can be changed by double clicking and typing a different value.

Lips at the front and rear of the body shell are needed to locate it accurately on the chassis.

Dimensions will be added to the sketch to specify 2mm lips and **Creo Parametric** will automatically sort out the other dimensions.

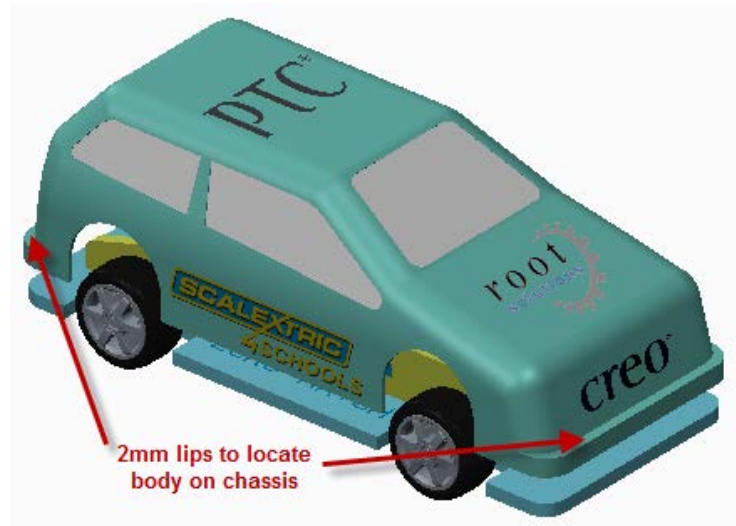

3. Adding a dimension

Dimensions are added by left clicking on the two extents of the dimension then middle clicking to locate the dimension text.

- Zoom in on one end of the car profile.
- In the sketcher toolbar, Dimension group, click the Normal  tool.
- Select the vertical edge of the base extrusion at **X1**.
- Select the end point of the sketched line at **X2**.
- Middle click at **X3** to place the dimension value.
- Type 2 and press **Enter**.

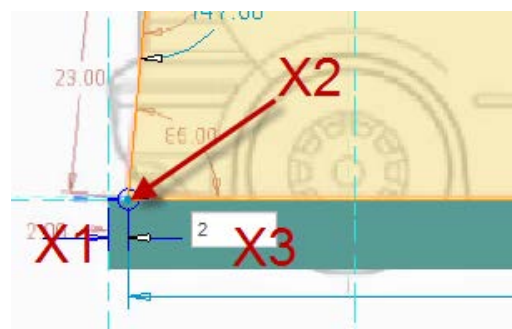

The dimension changes from **light blue** to **darker blue** denoting it is now a **strong** dimension. To ensure the sketch is not over-constrained, Creo has removed one of the weak dimensions.



This is a major strength of **Creo Parametric**. It constantly manages dimensions to fully specify the sketch.

4. Adding another dimension

- Create another 2mm dimension at the opposite end of the sketch.
- In the Sketcher toolbar, activate the One by One  selection tool.

5. Locking dimensions

Dimensions you do not want to change can be “locked”.

- From the In Graphics toolbar click **Refit** .
- Select one of the 2mm dimensions.
- Right click and from the pop-up menu, select **Lock**.
- Click in a blank region of the graphics area to deselect the dimension.

The dimension will change color to **brown** to show it is now locked.

- Lock the other 2mm dimension as shown below

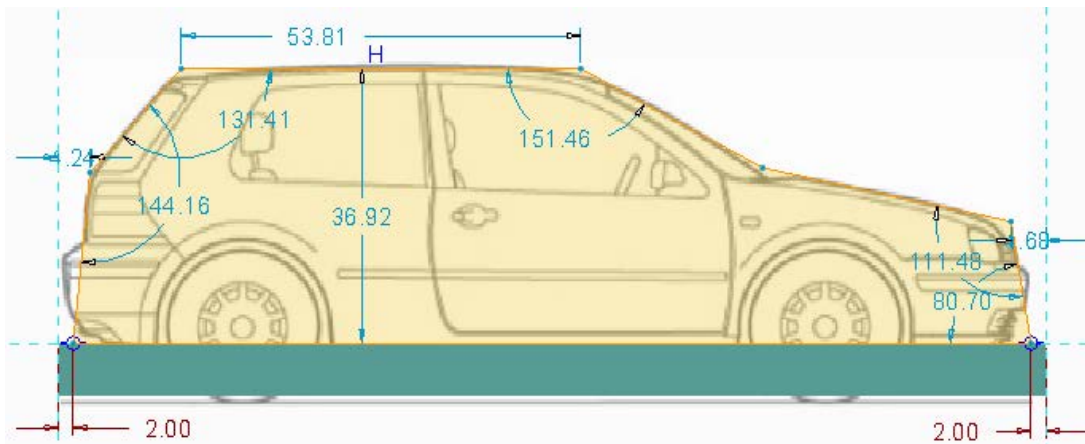

Drag lines to change shape

When you added the 2mm dimensions, other lines may have moved and no longer follow the shape of the image underneath. Lines that are not constrained with locked dimensions can be dragged.

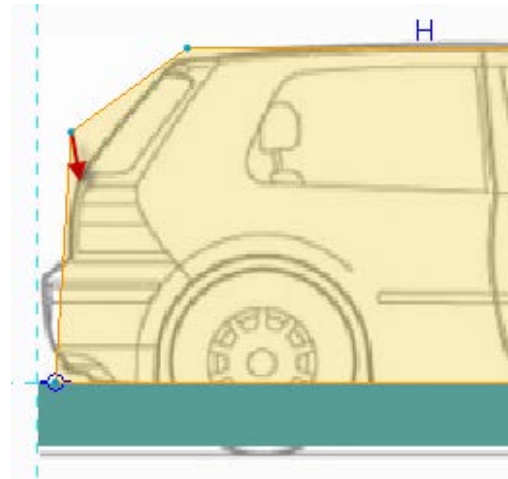

6. Moving sketched lines

- Click to select a node between two lines and then drag to re-align the node with the car shape.
- Continue moving nodes until the sketch matches the car profile image.



If the sketch changes shape unexpectedly, use the **Undo**  button or **Ctrl + Z**.

Fully constrained sketch

Product designers are mostly concerned with shape and proportion so dragging the nodes until the shape is how they want it would probably be sufficient.

Engineers don't like anything left to chance and would probably lock all the dimensions. You can do this too by following the dimensions on the image.

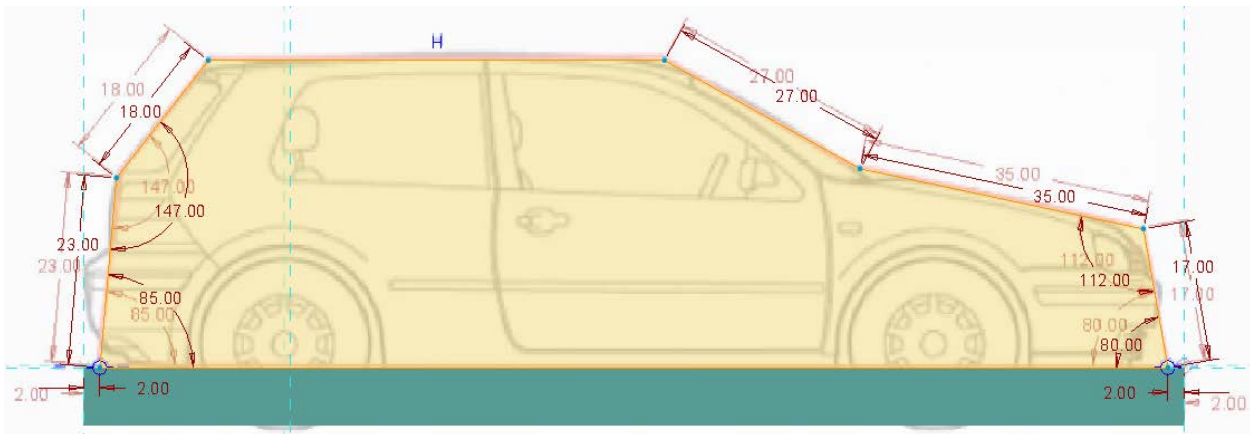

7. Complete the extrude

- Once you are happy with your sketched shape, check that it is still shaded and that there is a horizontal constraint **H** on the roof.
- From the **In Graphics** toolbar, **Saved Views** list  select **Trimetric**.

- When finished sketching, in the Close group, click **OK** ✓.

The Sketcher tab will close revealing the Extrude tab.

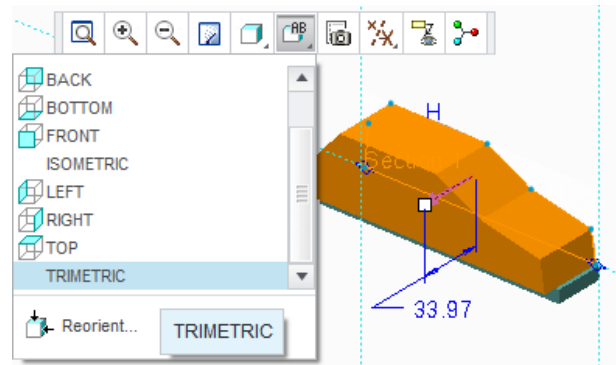

8. Setting extrude options

- Change the depth option to **Extrude to Selected** 

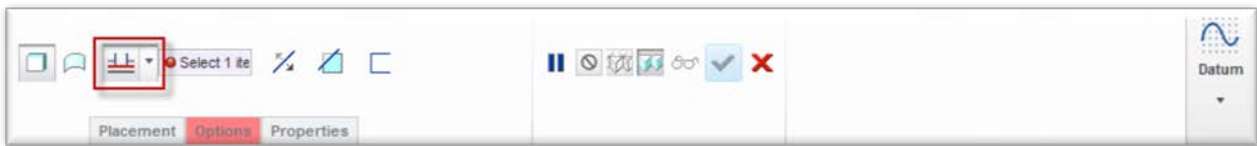

- Click to select the side surface of the base extrusion, shown outlined in green to the right.
- In the dashboard, click **Complete Feature** ✓ to complete the extrusion.
- From the Quick Access toolbar click **Save** .

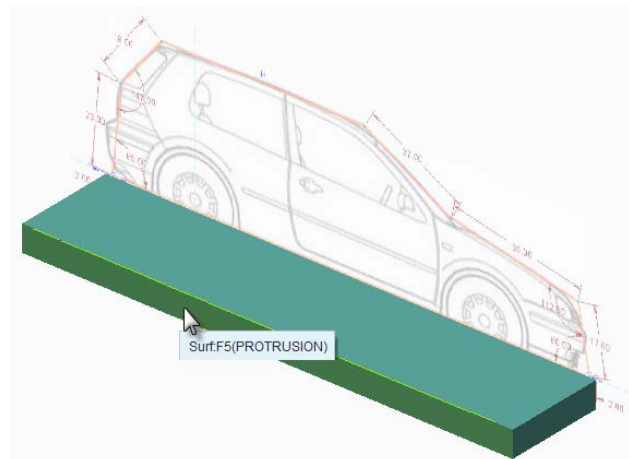

A new Extrude entry will appear in the model tree and the body will display as shown below.

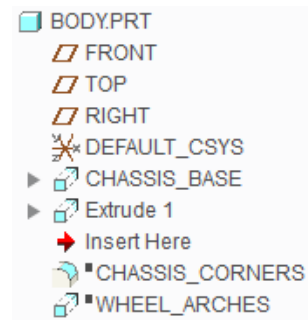
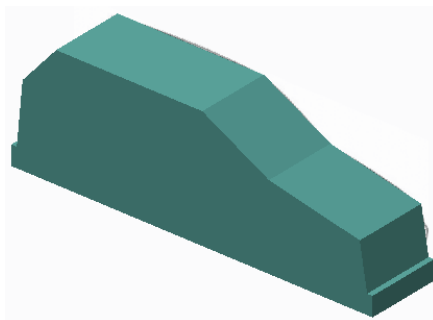



9. Hiding the profile image

We no longer need the car image so it can be hidden from view.

- Click the **View** tab
- In the Model Display group click **Images**

The Images toolbar opens.

- Open the Imported Images drop-down menu
- Select Side Elevation.jpg
- Click  **Hide** and the Side elevation image will be hidden.
- Click **OK** to close the Images toolbar
- From the Quick Access toolbar click **Save** .

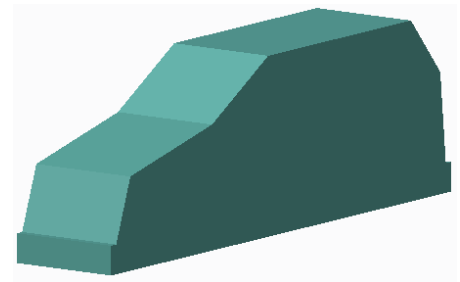
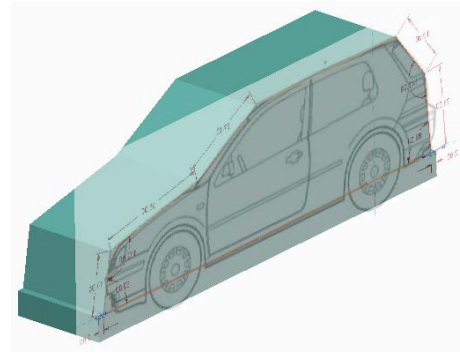

What have you learned?

- Sketcher – toolbar, sketch plane, line chain, drag geometry.
- Sketcher constraints – adding references to existing geometry.
- Sketcher diagnostics – closed loops, open ends, overlapping geometry.
- Dimensions – normal, weak, strong, locked, adding and changing.
- Extrusion – add material, depth controls.
- Model view – trimetric, sketch view

Task 7: Side taper

Expert/overview

Looking from the front of the car, the side needs to be tapered.

This will be done by drawing a diagonal line on the **RIGHT** datum plane referenced from the roof to the point where the hood/bonnet meets the side of the car.

The sketch will be extruded, removing material **Through all** in both directions.

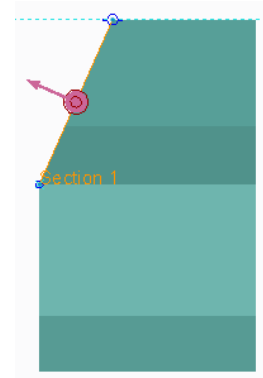

1. Start an Extrude

- In the **Model** tab, **Shapes** group, start the **Extrude**  tool.
- In the model tree, select the **RIGHT** datum plane as the sketch plane.

Creo Parametric will enter sketch mode with the sketch tab open across the top of the screen.

- From the **In Graphics** toolbar, click **Sketch View** .

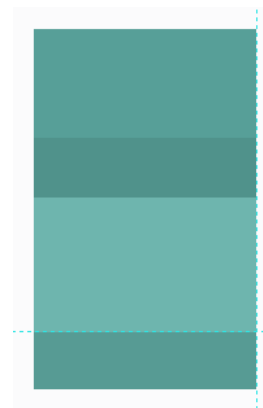

2. Sketching with references

Open loop sketches can be used to remove material but lines must extend beyond the model or attach to the edges of the model. Sketch references allow us to do this and can be created “on the fly”.

- From the Sketching group, Line Types drop-down menu, select **Line Chain** .

3. Creating references “on-the-fly”.

- Move the mouse cursor over the top edge of the model and hold down the **Alt** key on the keyboard.
- Click to create a line reference along the top surface.
- Release the **Alt** key to see the reference.

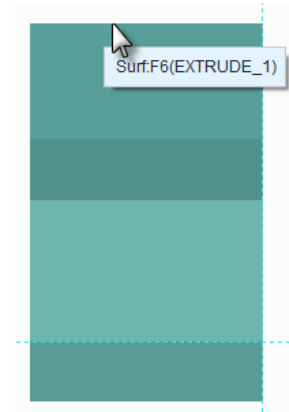

A dashed reference line will appear across the top of the model.

- Move the point of the mouse cursor arrow precisely over the front corner of the hood/bonnet, hold down the **Alt** key and click to create a point reference.
- Release the **Alt** key and a very small **light blue** “Point reference” **x** will appear.

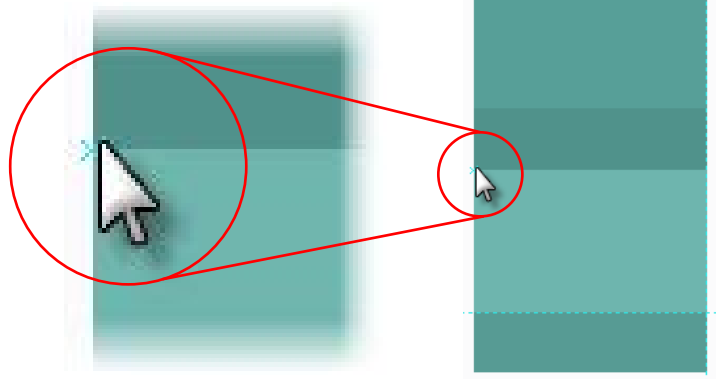



4. Drawing the cut line

The **Line Chain**  tool should still be active.

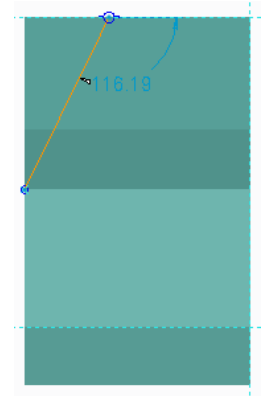
- Draw the diagonal line shown here making sure the ends snap to the references you have just created.
- Middle mouse button twice to cancel the **Line Chain**  tool.
- If necessary drag the top of the line along the reference until it is angled as shown here on the right.



- When finished sketching, from the Close group, click **OK** .
- From the In Graphics toolbar, click Named Views , and from the drop-down menu, select **Trimetric**.

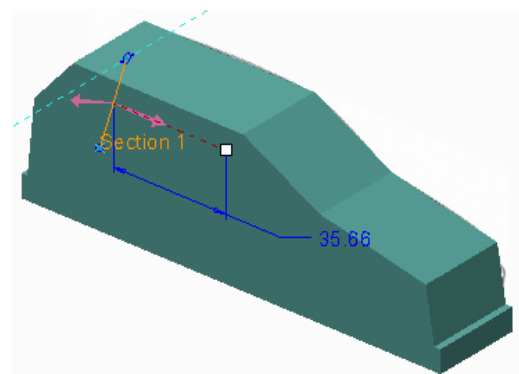

5. Changing extrude settings

- In the Extrude tab, change the choices to those shown below.
- Ensure that Extrude as Solid **X1** has been selected.
- Click **Blind** and select **Through All X2** from the drop-down menu.
- Click Remove Material **X3**.

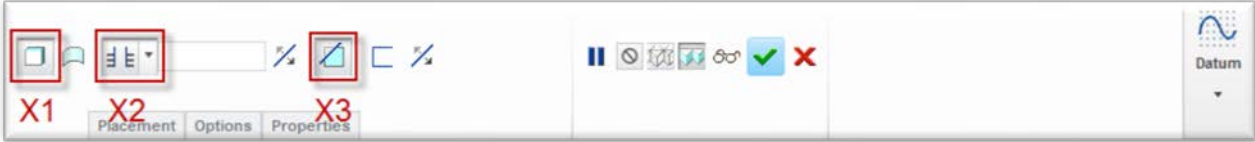

- Change the options so that material is removed through the entire model
- In the dashboard, click the **Options** tab to open the drop-down panel.
- Change the **Side 2** option to extrude **Through All**.
- Make sure the **purple** arrow is pointing away from the model.

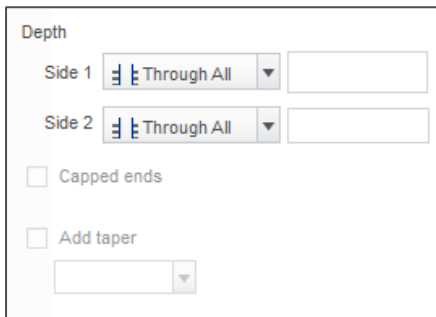
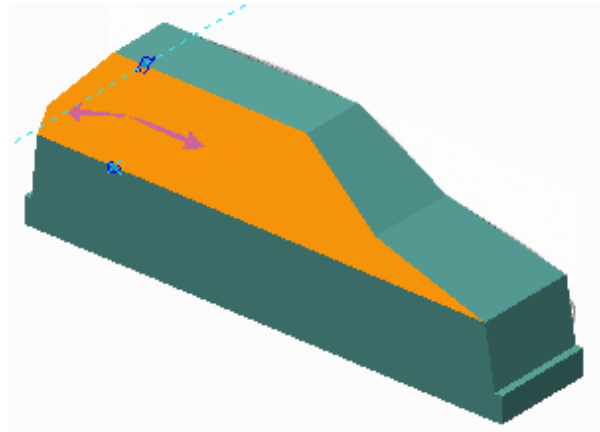

6. Complete the extrude feature and save your work.

- Click **Complete Feature**  to complete the feature.

The side of the car body will now be angled.

- From the Quick Access toolbar, click **Save** .

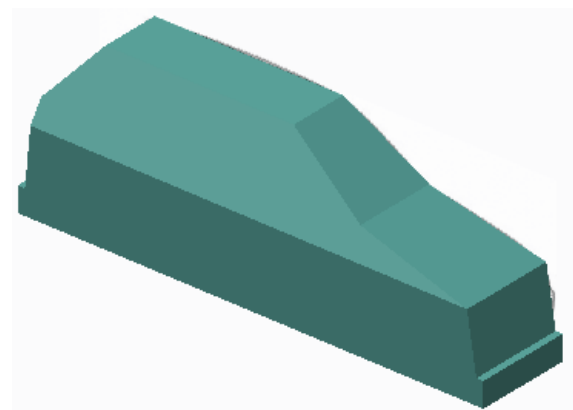

What have you learned?

- Sketcher – toolbar, sketch plane, line chain, drag geometry.
- Sketcher constraints – adding references to existing geometry.
- Extrusion – dashboard, remove material, depth controls.
- Model view – trimetric, sketch view.

Task 8: Rounds

Expert/overview

Three rounds will be added to the edges arrowed in the order **30mm**, **8mm** then **5mm**

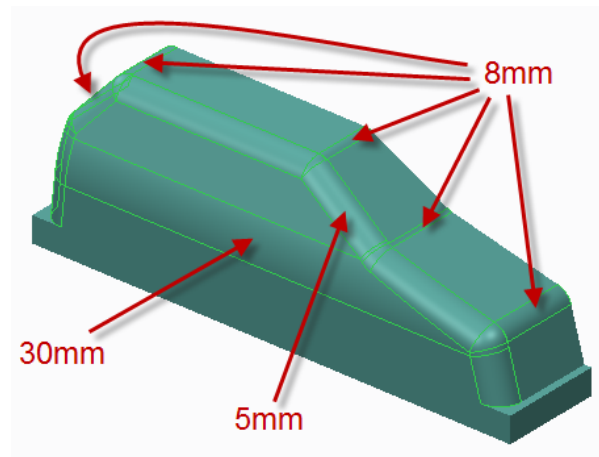

1. Adding a round feature:

- From the Model tab, Engineering group, click **Round** from the Round Types drop-down menu.
- Click to select the edge shown in **green**.
- In the Round tab, change the radius to **30** and press **Enter**.
- Click **Complete Feature** ✓ to finish the round feature.

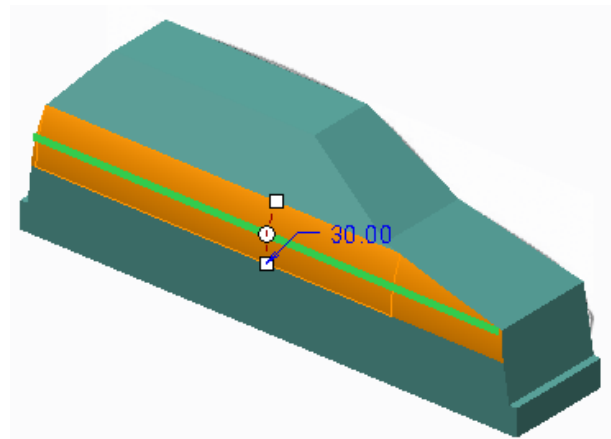

2. Adding more rounds:

- From the Model tab, Engineering group, click **Round** from the Round Types drop-down menu.
- Hold down the **Ctrl** key and select each of the edges shown here in **green**.
- In the Round tab, change the radius to **8** and press **Enter**.
- Click **Complete Feature** ✓ to finish the round feature.

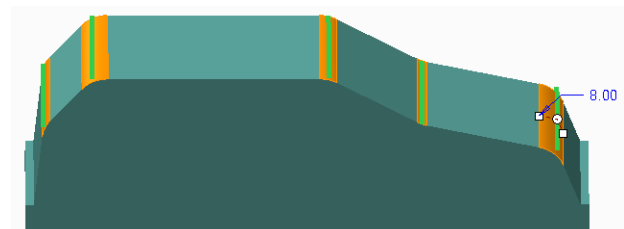

- Add another Round feature of **5 mm** radius to the edge shown in **green**.

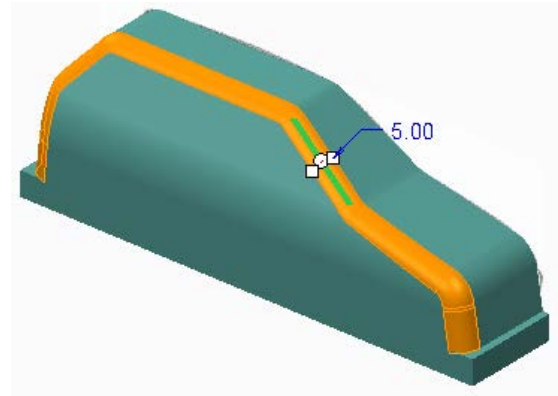

Creo Parametric continues the round along all edges that are tangential.

- From the Quick Access toolbar, click **Save** .

What have you learned?

- Round feature.
- Multiple select (Ctrl key to add/remove selections).
- Edge references.

Task 9: Complete the mold

Expert/overview

To complete the mold you will move the Insert here flag down one feature in the model tree and then mirror the model about the **FRONT** datum plane.

1. Resume a feature

- In the model tree, drag the **➔ Insert Here** flag below the **CHASSIS_CORNERS** feature.

The corners of the base extrusion will now be rounded.

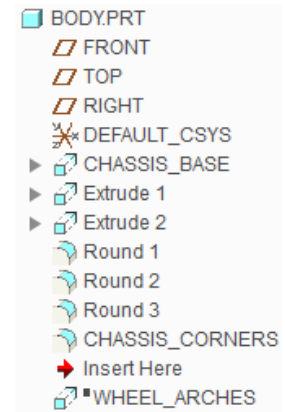
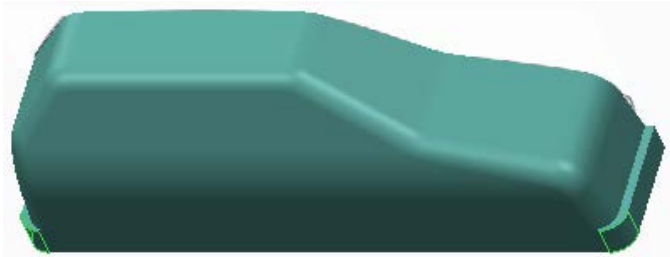

- From the In Graphics toolbar, click the Datum Display Filters list , and enable only the display of datum planes.

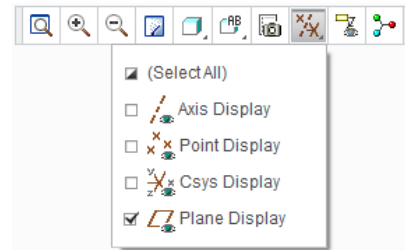

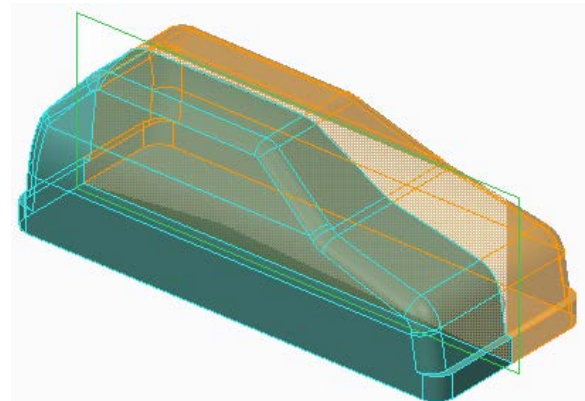

2. Mirror the model

- In the model tree, click on **BODY.PRT** to select it.
- In the Model tab, Editing group, click **Mirror** .
- In the model tree or the graphics area, select the **FRONT** datum plane as the mirror axis.



3. Complete the feature and save your work.

- From the In Graphics toolbar, click the Datum Display Filters list , and disable the display of all datum features.
- Click **Complete Feature**  to complete the mirror feature.
- Click **Save** .

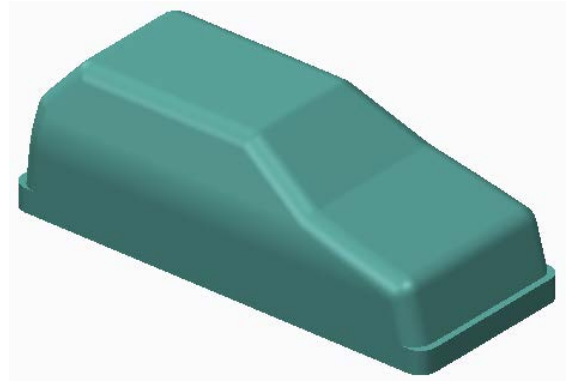

Task 10: Model properties

Expert/summary

While the shape of the body mold is complete, we still need to specify Balsa as the material it will be made of together with the name of the part, who modeled it and the project it is part of.

1. Editing model properties

- Click **File > Prepare > Model Properties**.
- In the Model Properties dialog box, next to Materials click **change**.



- In the Materials dialog box, select **Wood_balsa.mtl**.
- Click **Assign** and then click **OK**.

Creo Parametric will apply this material to the model.

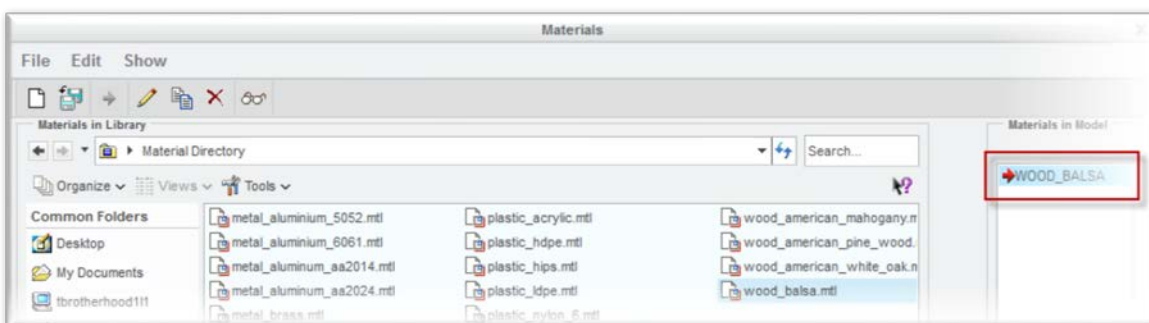

This will not alter the external appearance of the part. It has changed the density/mass and physical properties of the model so that measurements and analyses report accurate results.

The next step is to assign parameters to the part.

2. Assigning model parameters

- From the **Model Properties** dialog box, click **change** next to **Parameters**.
- From the Parameters dialog box, in the Value column:
- Next to DESCRIPTION, type S4S_BODY
- Next to PROJECT type SCALEXTRIC4SCHOOLS.
- Next to **MODELLED_BY** type your name.
- Click **OK** to close the Parameters dialog box.
- Click **Close** to close the Model Properties dialog box.
- Click **Save** .

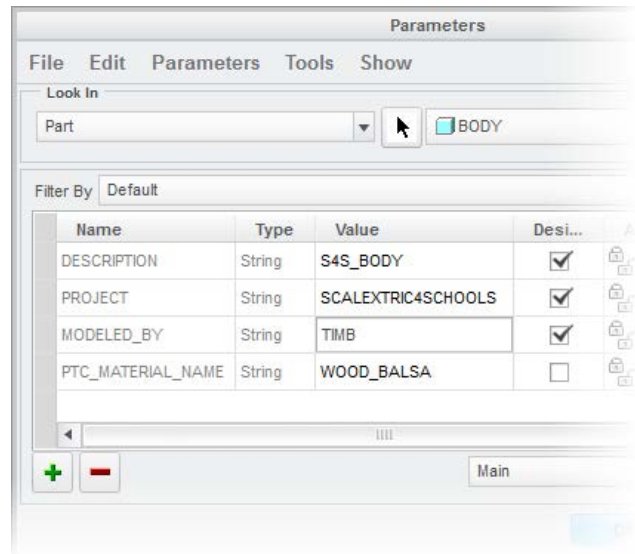

What have you learned?

- Model properties – assigning material properties, description, project and modeled_by properties to a model.
- Measurement and analyses – awareness of material properties and they affect measurements and analyses.
- Saving your work.

Task 11: STL file for machining

The most common file format used to transfer 3D shapes to machining software is STL. The companion document 'Make - assemble - setup' booklet contains a full description of the STL file format, post processing and CNC machining.

Expert/summary

Here you will be shown how to export an STL file of your model configured for a fine mesh surface.

1. Exporting an STL file.

- Click **File > Save As... > Save a Copy** and, in the Save a Copy dialog box, change the **Type** to Stereolithography (*.stl).

The default filename uses the part name with an .stl extension.

- Click **OK** to save your model as BODY.STL

2. Defining the mesh size.

- In the **Export STL** dialog box, change the **Chord Height** value to **0** (zero).

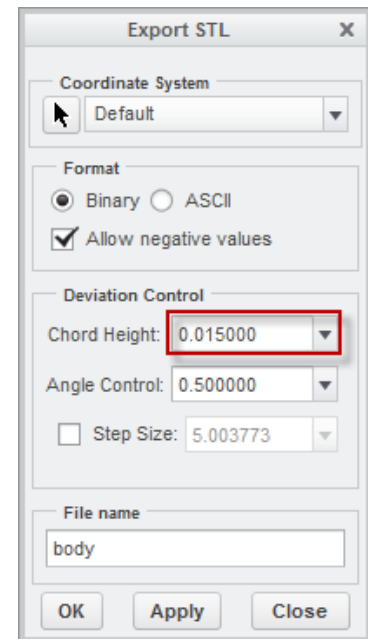

Creo Parametric will enter the smallest practical value for Chord Height. The resulting number is based on the size and complexity of the part.

- Accept the other defaults and click **OK** to create the STL file and close the dialog box.

The display will change to show the faceted surface of the STL file.

3. Check your work and repaint your model:

- Zoom in to a curved corner to see the triangular surfaces created by the STL conversion.
- From the **In Graphics**, toolbar click on **Repaint**  to repaint the screen and return to the parametric model.

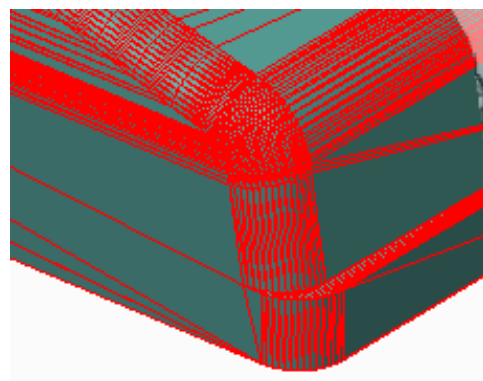



: A description of the machining process can be found in the accompanying 'Make – assemble – setup' document.

What have you learned?

- .Awareness that STL is an industry standard format for manufacturing files.
- Awareness that STL conversion creates a quilt of triangular facets on the surfaces of a model.
- Understanding that facet size is controlled using the “Chord Height” variable.

Homework one – Car performance

- Before the next session read through the section **Car performance** in the **Design Guide** booklet for this project.

Session two: Physics of car performance

Task 1: Review homework.

Based on your homework task, your teacher will help the group create a list of key physics principles affecting car performance. These will be useful later when re-designing your car.

Task 2: Review design factors

In design teams you will create a set of bullet points to guide the development of your car design.

Competitions

You will be racing other students or teams and to make sure competition is fair a set of rules have been created. Rules for the Scalextric4Schools Challenge are published on the www.scalextric4schools.org web site.

Next you will be shown how to convert your paper sketches into a 3D CAD model, then how to make changes to existing parts and finally learn about alternative 3D modeling features.

Homework 2: Design sketches

- Refer to the Design guide for detailed instructions on sketching ideas for body shapes.

Homework 3: Hornby the company

- Read through the 'Hornby the company' section of the 'Design guide' for this project.

You will be asked questions on this at the start of the next session.

Session three: Modify Creo Parametric models

Outline

During this session you will learn how to modify existing designs, correct some of the faults that can occur and hear about other 3D modeling tools.

Task 1: Hornby the company

Your teacher will ask the class to show their knowledge of Hornby, one of the foremost companies in the world designing and manufacturing slot cars.

Task 2: Dealing with failed features

This example shows changes to the body mold profile and how this makes the subsequent Round feature fail. Read through this so that you will know what is happening when failures occur.

In the diagrams below, the body profile has been edited changing it from a hatchback to a sedan/saloon.

Before

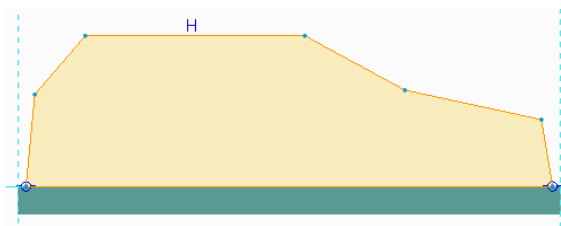

After

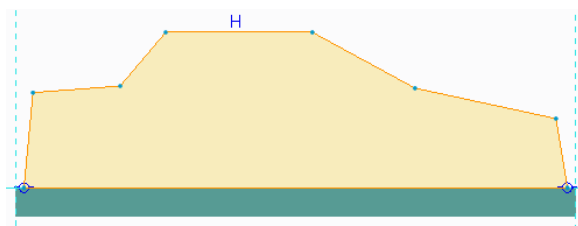

When it was created, the round features shown on the right referenced the five edges across the car.

The round feature is 'child' to the five 'parent' edges.

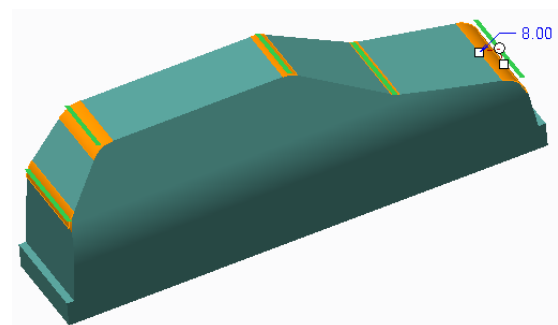

When changes were made to the profile sketch, an extra edge was created at the base of the rear window.

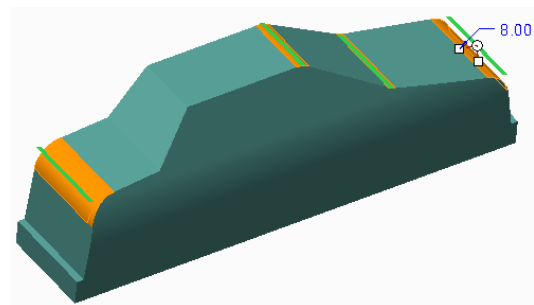

The round cannot work out which of the new edges to use so the round feature and others below have failed.

Creo Parametric reports modeling failures with a drop-down message like the one below.

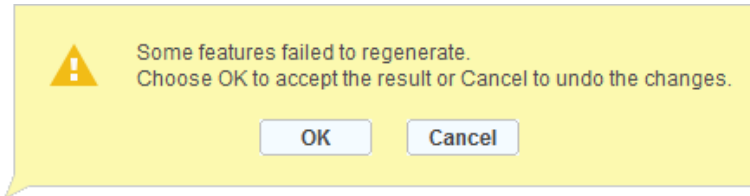

Edit Definition allows us to correct the errors.

Here **Edit Definition** was used to re-open the **Round 2** feature in the model tree. The **Sets** tab is where edge references and radii are recorded.

Scrolling down the references list revealed one failed edge reference (🔴) and two ambiguous edge references shown in yellow (🟡).

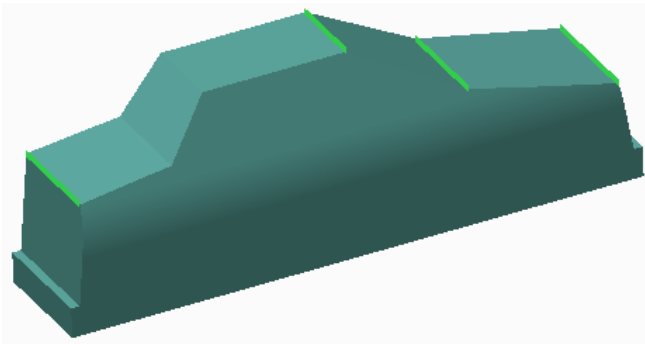

The failed entries are removed by right clicking on each one and, from the pop-up menu choosing **Remove**.

New edges are then added by holding down **Ctrl** and selecting the new edges.

The Round feature is then completed by clicking Complete Feature ✓.

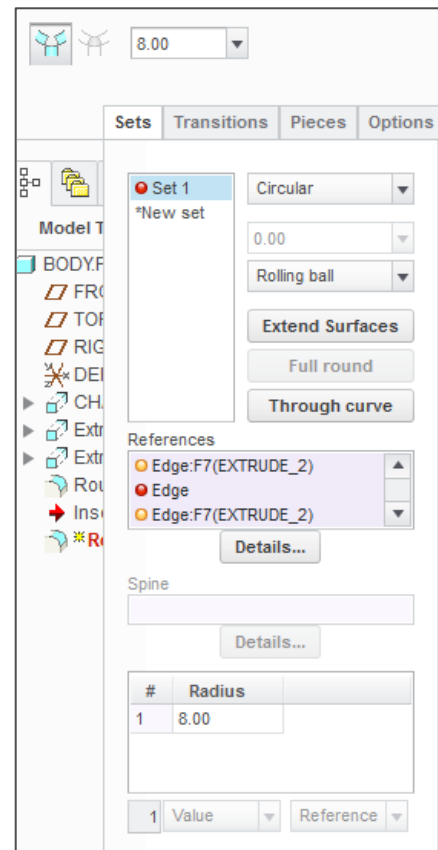
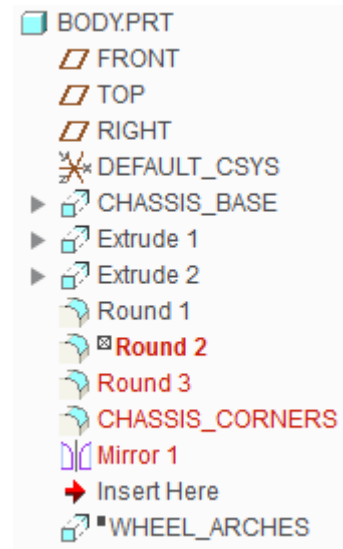

Correcting the parent edges in the first failed Round has resulted in the lower failures being resolved automatically.

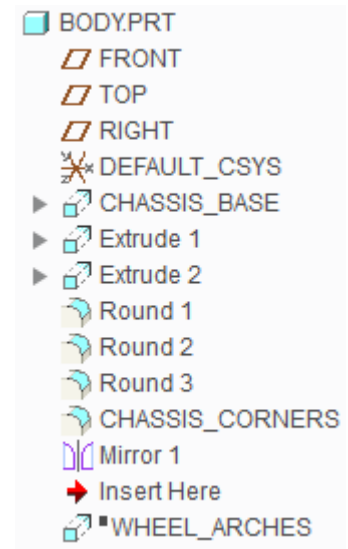
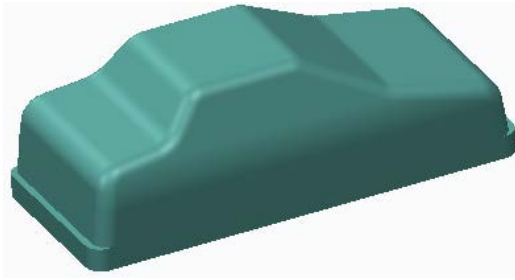

Creo Parametric is now able to regenerate the model successfully.



: Making changes to complex models may generate several failed features that should be corrected before continuing to model.

What have you learned?

- Aware of Hornby the company, its history and products.
- Causes of regeneration failure.
- Introduced to Parent - Child relations.
- Editing a Round feature – Edit Definition, removing and replacing failed references.

Task 3: Reverting to a previous version of a part

We shouldn't need to mention the importance of saving your work regularly!

When a part or assembly is created in **Creo Parametric**, a number is added after the file extension.

Each time you make changes to a part or assembly and save, another new file is created with the number incremented. Here is an example where the base part was saved sixteen times during development.



If changes to a model go seriously wrong you can close the part, erase the model from memory and then open a previous version.

1. From the Quick Access toolbar, click **Open** .

- In the **Type** drop-down list, select **Part (*.prt)**
- In the **Tools** drop-down list select **All Versions**.

You will now be able to see all the versions of each file.

2. Select one of the earlier versions of **BODY.PRT** and click the **Preview** button.

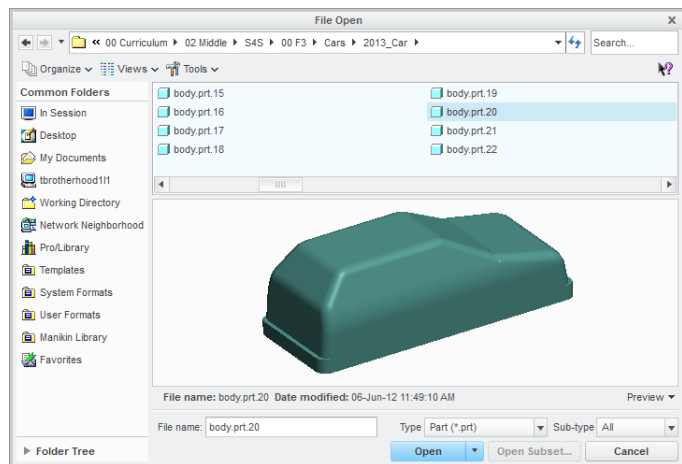

A preview of the earlier version is shown and can be opened.

Homework three – Competition rules

- Take a copy of the competition rules home with you. They are available on the challenge web site - www.scalextric4schools.org
- Read through them carefully.
- Read through again looking for opportunities to design a car that will be quick around the track.
- Write down a list of the top five things you think will make a car quick.
- Bring the list with you to the start of the next session.

You now have some of the knowledge to design your own car.

What have you learned?

- **Creo Parametric** creates numbered copies when files are saved.
- How to view and open previous versions can be opened.
- Aware of competition rules.

Extension one: Alternative modeling strategies

If you found the **Creo Parametric** modeling easy so far, you may want to know about a few other 3D features and modeling strategies that could be used to create a car body.

Blend

Sometimes called loft this uses cross sections that Creo joins up to create a solid or surface. All sections must contain the same number of lines

Precision LMS - Advanced Modeling.

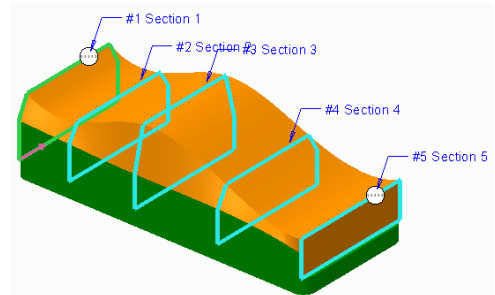

Variable section sweep

A very powerful tool that uses a single cross section sketch projected along one or more control curves to create a variable cross-section surface or solid.

Precision LMS - Advanced Modeling.

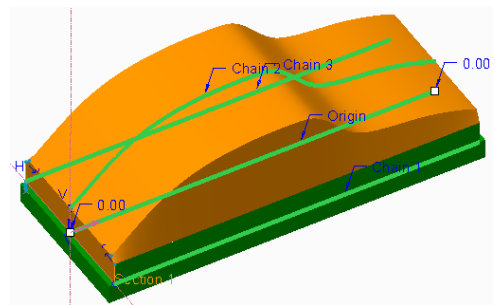

Warp

The warp feature is a collection of tools that allow existing shapes to be distorted in a very 'organic' way. There are no sketches involved; instead, frames surround the affected area while points and edges on a mesh are pushed and pulled to change the model.

Precision LMS – Advanced Modeling.

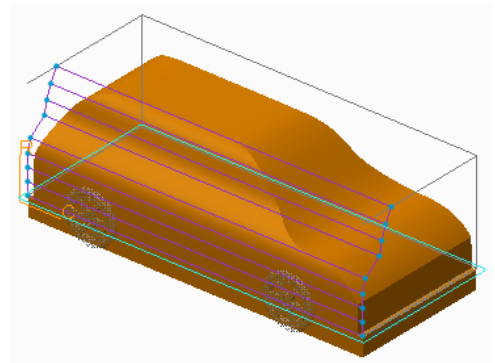

Homework – Change request

When a commercial product requires modifying the design team agrees to a change request. This is similar to a product specification and lists the changes needed.

Your task is to create a 'change request' listing the modifications needed to change the standard car body design to match your revised design. You will need your change request in the next session.



Use your experience of the model tree to help you order your list of changes.

Session four: Own design

You now have sufficient experience to model your own body. However you may find the following design guidance helpful

From previous homework you should have several sketch ideas for car shapes drawn on templates.

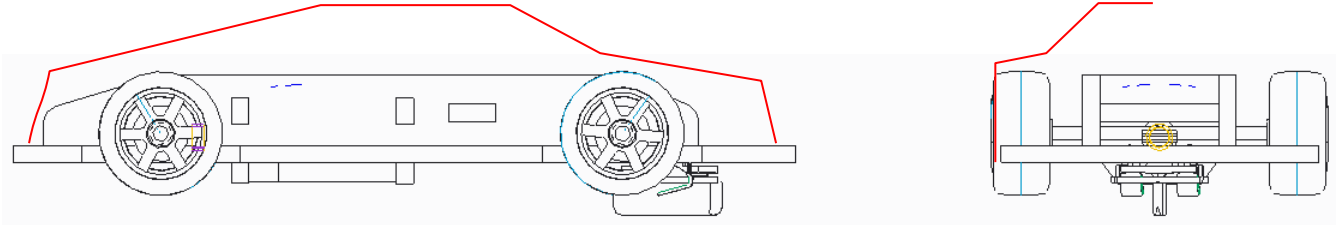

You should also have a 'change request' list of modifications to make.

Task 1: Preparing your drawings

1. Scanning images

- Choose one of your design sketches.
- Use a scanner to capture your drawings into the computer. Create two images of the car like the ones shown below.

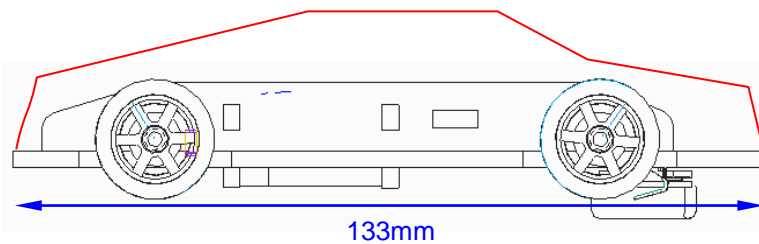

Car_name_side.png

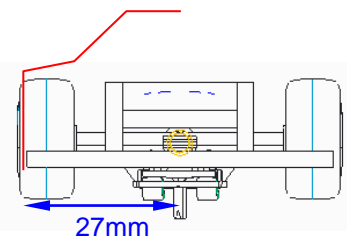

Car_name_front.png

- Name the files **Car_name_side.png** and **Car_name_front.png**, saving them in the directory where the Scalextric4Schools Creo models are saved.

Task 2: Tracing over Images

Creo Parametric allows you to insert and scale images as a reference to trace over. In the following task we will use images named **SKETCH_SIDE.png** and **SKETCH_FRONT.png**. You should use the images you have drawn, scanned and saved.

1. Opening a start part.

- From the Quick Access toolbar, click **Open**  and select the part **BODY_TRACE.PRT**.
- Drag the **Insert here** flag between the **CHASSIS_BASE** and **CHASSIS_CORNERS** features.

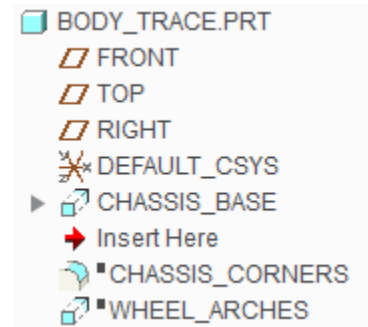

2. Adding an image

- From the **View** tab, **Model Display** group, select **Images** from the Model Display drop-down menu.

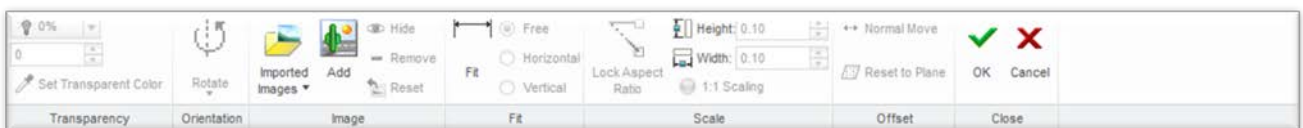

- From the **Image** group, click **Add** .
- In the model tree, select the **FRONT** datum plane.
- In the Open dialog box, browse to the working directory, select **SKETCH_SIDE.PNG** and click **Open**.

2. Refit the model in the graphics area.

- If necessary, from the In Graphics toolbar click **Refit** .

You can now see that the image placed on the FRONT datum plane

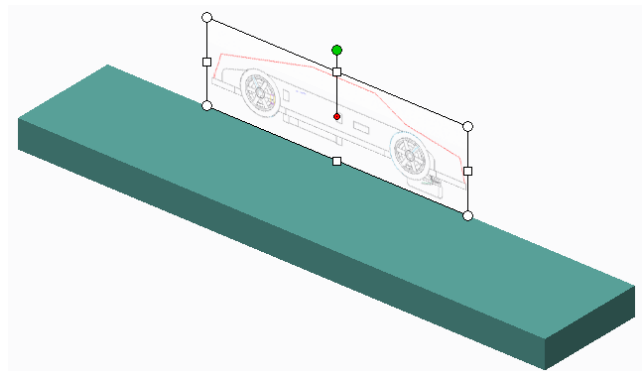

The sketch you have just placed needs to be scaled and positioned.

3. Scaling the image

- From the In Graphics toolbar, click **Named Views** , and select **FRONT** from the drop-down menu.
- From the **Images** tab, **Fit** group, click **Fit** and select **Horizontal** radio button.
- Drag the red dots until the vertical limit lines align with the ends of the chassis.
- Double click the dimension, type **133** and press **Enter**.

The image will be rescaled to 133 mm wide while maintaining the image aspect ratio. An alternative dimension you could use is the wheelbase which is 78.5 mm.

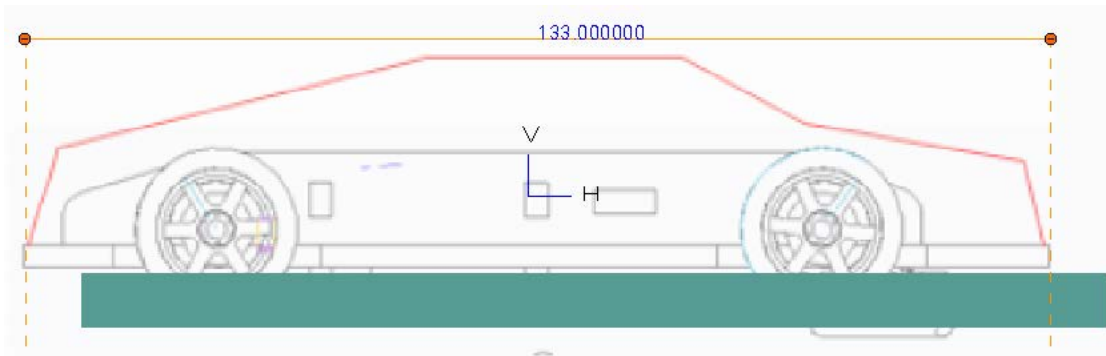

4. Repositioning the image

- From the **Fit** group, click **Fit** to deselect the Fit tool.
- In the graphics area, drag the image aligning the top of the chassis in the image with the top of the chassis model.

The image below shows the image correctly aligned with chassis base in the model.

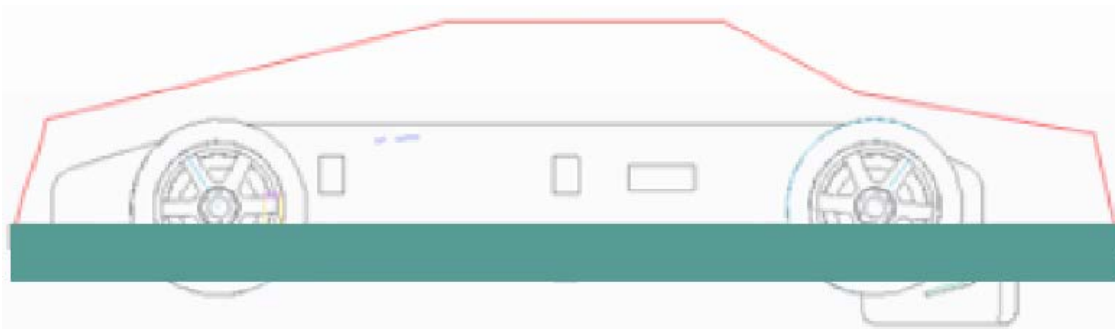

Take a look at the other options in the Images dashboard including altering the transparency of the image.

When you are happy with the scale and location of your image, from the **Close** group, click **OK**



- Repeat the process in order to place the **SKETCH_FRONT.PNG** image on the **RIGHT** datum plane.
- If necessary, rotate the image by 90 degrees.
- Edit the horizontal width to be 27mm.

Your instructor/teacher will now help you create a **Creo Parametric** model of your design of car.

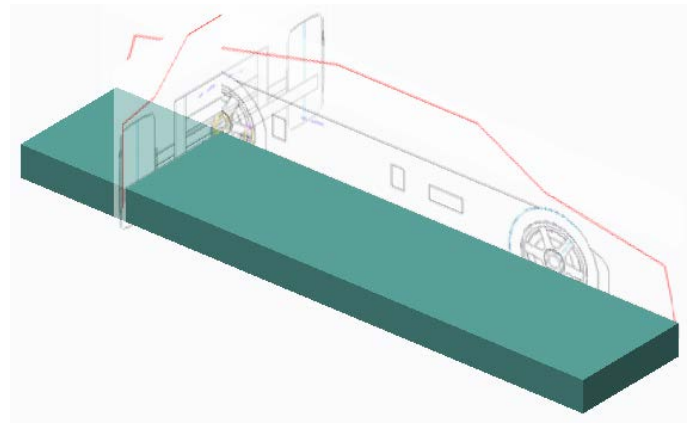

Homework four – CNC machining

Research CNC machining and write a description of:

- How a 3D CAD model is transferred to the computer controlling the machine tool.
- How the machine tool software creates instructions for the machine.
- How the machine removes material.
- The advantages of CNC machining.
- The disadvantages of CNC machining.

Session five: Machining

The Make-Assemble-Setup guide contains a detailed description of taking the **Creo Parametric** model of the body mold through to the machined vacuum forming mold.

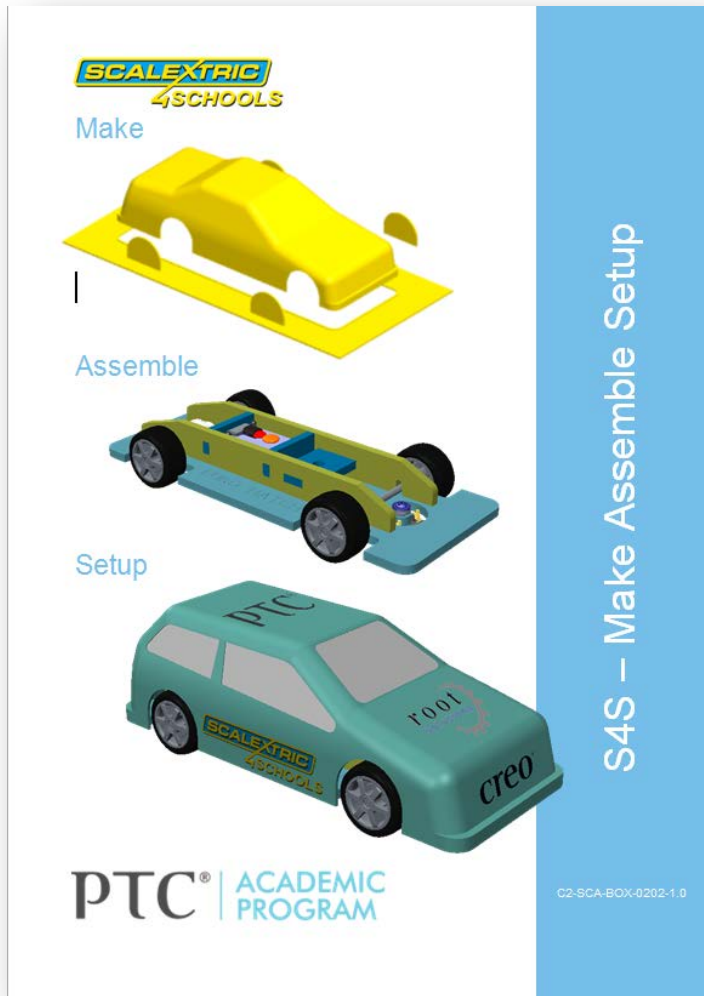

Homework five – Parts design and manufacture

Would it be cool to spend your working day recreating the latest dream cars as Scalextric models? Interested in how it's done? Read the section about Darren in the 'Design Guide'.

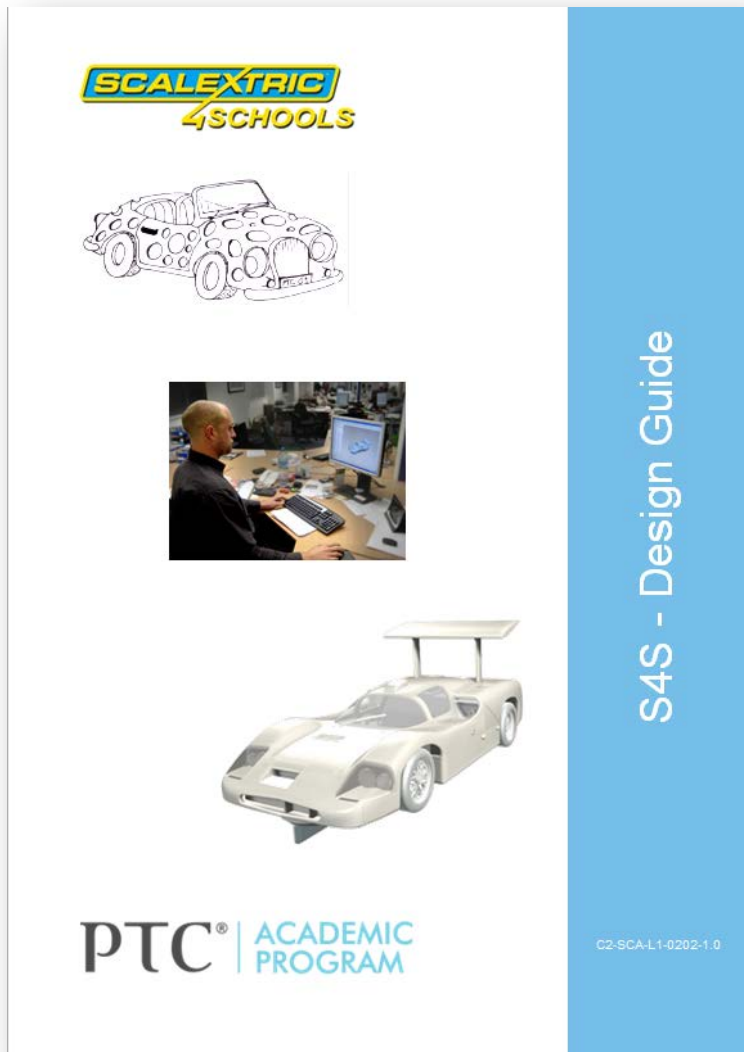

Session six: Car assembly

The Make-Assemble-Setup guide contains a detailed section on how to assemble the chassis for this project.

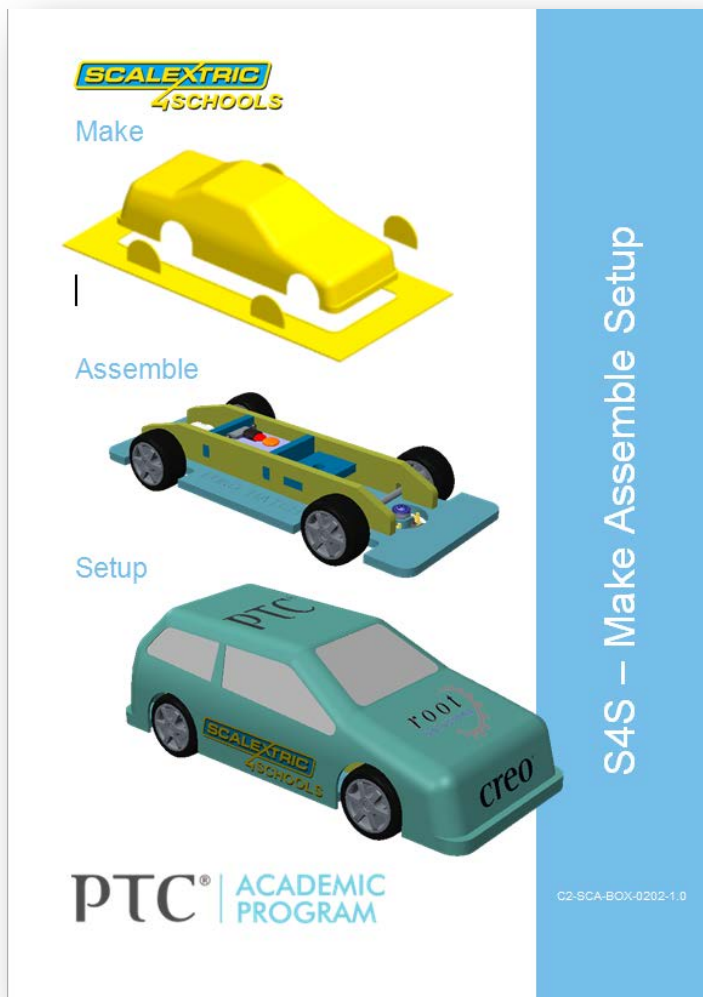

Session seven: Testing, analysis and simulation

Simulating car performance

In the past, designers and engineers would build real prototypes to test their designs. They were tested and the results used to make improvements. It could take months even years to build physical prototypes and testing could be hazardous to the operator.

The prototype to the right was the forerunner of the Harrier /AV8B 'jump' jet. The air intake 'cuffs' are evidence of significant changes made as a result of testing and before production started. A prototype harrier crashed at the Farnborough air show in front of large crowds.



www.wikipedia.org

A major advantage of computer modeling is the ability to test and evaluate virtual designs in 3D. This reduces the time and material costs of making physical prototypes.

Analysis tools in 3D modeling software are developing all the time and the following tests have been developed for Creo Parametric models of Scalextric cars.



Creo Parametric has extensive measurement and analysis tools and these can be used to evaluate the virtual model to assess how well it might perform before making and testing a physical prototype. There are obvious benefits in doing this including faster development of design variations and reduced cost of materials and manufacture.

The analyses covered here include:

Static measurements:

- Mass and center of gravity (C of G)
- Frontal area

Dynamic analyses:

- The effect of center of gravity on lateral stability
- Acceleration in a straight line

Creo Parametric models

Several simulations have been created based on the standard car model. These should help you learn about the science and math of movement and help you understand how to design a faster and more efficient car.

The **Creo Parametric** models for these analyses can be downloaded from the challenge web site at: www.scalextric4schools.org

Task 1: Mass/C of G measurement

The mass of a design will have a major impact on acceleration. A lighter car will accelerate faster than a heavy car providing the wheels do not spin. Most racing formulae restrict the mass of a car usually with a lower limit to make sure designers do not reduce the mass to the point that the structure is not strong enough to protect the driver.

1. Getting started

- If necessary, start **Creo Parametric**.
- Set the Working Directory to the location for your tutorial models.

2. Opening an assembly:

- From the **Home** tab or **Quick Access** toolbar, click **Open** 
- Select **2013_S4S_ANALYSIS.ASM** and click **Open**.

3. Analyzing the mass properties:

- From the **Analysis** tab, **Model Report** group, select **Mass Properties** from the Mass Properties types drop-down menu.
- In the Mass Properties dialog box click **Compute**  to run the analysis.

The dialog box now shows the mass properties and coordinates for the center of gravity.

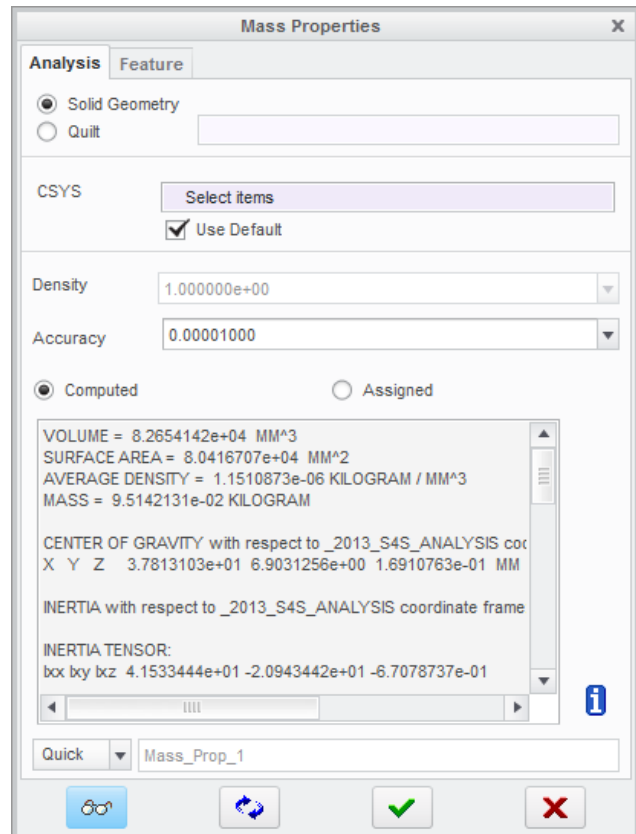

In this example the mass is reported as **9.5142 e-02 KILOGRAM** which is 95 g.

While the Mass Properties are displayed in the dialog box, the model will display two sets of coordinates. The XYZ coordinate system at the center of the rear axle is the default for the assembly and is used as a reference to report the center of gravity for the entire model.

- **Rotate** and **zoom** the model to examine where the C of G is located.
- From the Mass Properties dialog box click **X** to cancel and close the Mass Properties dialog box.

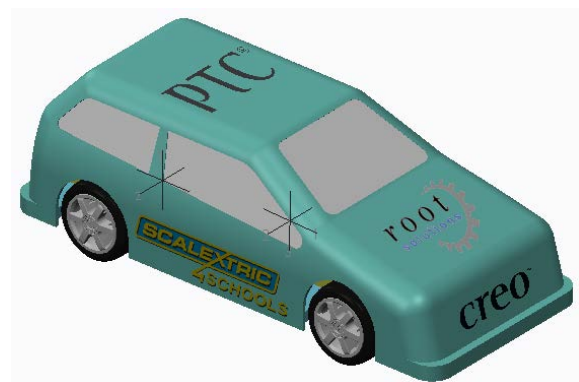

4. Close the model and erase parts from memory.
 - **DO NOT** save the model.
 - From the Quick Access toolbar, click **Close**.
 - From the Home tab, Data group, click **Erase Not Displayed**.

You may want to try out some of the following items.

Mass

- Open Z_BODY.PRT.
- Check the material e.g. **plastic_hips.mtl** and note it's density.
- Carry out mass measurement.
- Change material to polyethylene – and note its density.
- Carry out another mass measurement.
- Compare the results and densities between the two models.
- What would be the effect of using one of the following materials?
 - acetal, acrylic, nylon, polycarbonate.
- You may need to look on the web for the densities of some of these materials.

www.matweb.com

Design hint: Reduce the mass of your car by removing material where it is not needed. Move heavy components as low as possible and reduce the overall height of the car as much as possible.

Density

- Find the density of a material by experiment
- Predict the impact on performance of using the new material.
- Make the changes to your model then take measurements of mass.
- Interpret the results in terms of performance.
- Use your conclusions to prompt further changes to your design.

Task 2: Frontal area

A key factor in car performance is the size of the “hole” the car makes as it travels through the air. The term “frontal area” is used to describe this and **Creo Parametric** has a **Shadow** tool that we can use to measure frontal area.

Shadow analysis

1. Opening the shadow analysis model.

- From the Quick Access toolbar or the Home tab, click Open .
- Select **2013_S4S_ANALYSIS.ASM**
- In the model tree, right click on the **Fill_1 feature** and click **unhide** from the floating menu.

2. Shadow analysis

- From the **Analysis** tab, **Inspect Geometry** group, select **Shadow** from the **Inspect Geometry** drop-down menu.
- Select the purple surface behind the car.
- In the Shadow dialog box, select the **Model** field and, in the model tree, select **2013_S4S_ANALYSIS.ASM**
- In the Shadow dialog box, select the **Direction** field and then select the surface behind the car.

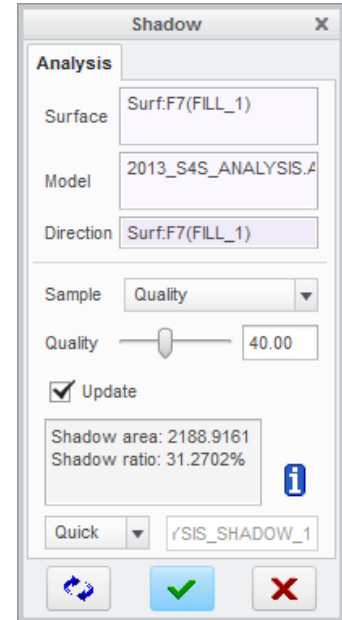

- Click on the **magenta** arrow in the graphics area to reverse the direction for projection.

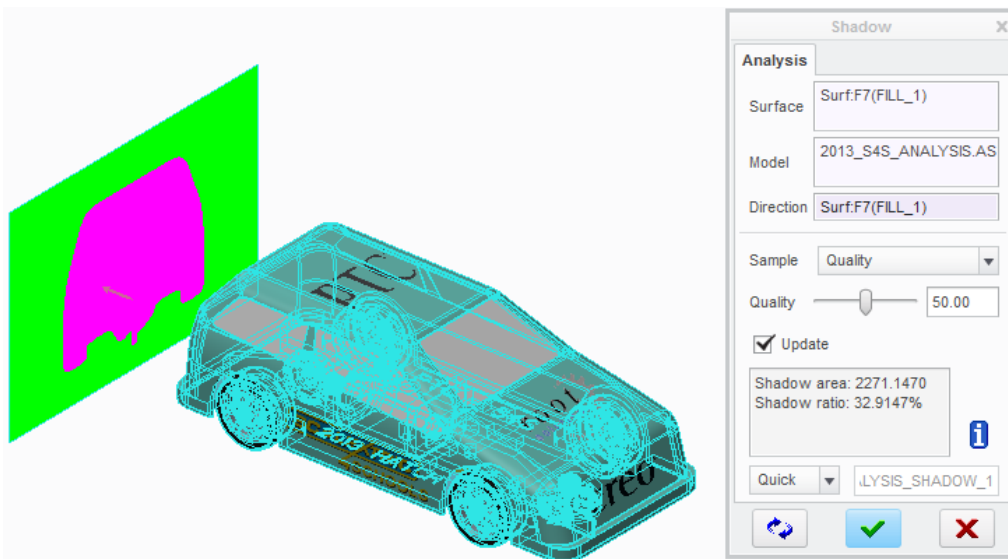

You are now seeing the shadow on the surface behind the car. The dialog box will show the area of the shadow and the percentage of the surface that the shadow fills.

This analysis shows the size of the hole that the car is making in the air as it travels along.



- Click **X** to close the Shadow dialog box.

3. Closing the model and erasing parts from memory:

- **DO NOT** save the model.
- From the Quick Access toolbar click **Close** .
- From the **Home** tab, **Data** group, click **Erase Not Displayed** .

Task 3: Center of gravity and stability

Center of gravity is an imaginary location where all the mass of an object can be considered to act. The position of the center of gravity will determine how well the car will go around corners.

Cornering

The slot guide steers the front of the car round the corner while friction between the rear wheels and the track keeps the car from sliding or spinning. Analyses have been provided for you to experiment with.

Effect of C of G on cornering

Remember the cartoon in the Design Guide showing a bus being tilted on a platform until it falls over?

Here is the real thing. The test for double decker buses in London was a 28 degree tilt. All four tires must remain in contact with the platform at this angle.

Notice the sloping wall to catch the bus if it begins to tilt!

<http://www.20thcenturylondon.org.uk/>



An assembly has been created with the standard car 'hinged' to the track by the edge of the tire. Using the mechanism module in **Creo Parametric**, gravity is applied and the track is gradually tilted.

When gravity acting at the center of gravity falls outside the wheelbase the model tips over.



From this we can infer a tall car will be more likely to topple over so we will analyze the design by gradually tipping the track until the car falls over. The track angle gives an accurate guide to how stable a car will be.

1. Starting Creo and setting the working directory:

- If necessary, start **Creo Parametric**.
- From the **Home** tab, **Data** group, click **Select Working Directory**.
- Navigate to the folder **2013_S4S_Car**.
- Click **OK** to set the folder as the working directory.

2. Opening the analysis model:

- From the Quick Access toolbar or the Home tab, click **Open** .
- Select C_OF_G_TILT.ASM and click Open.

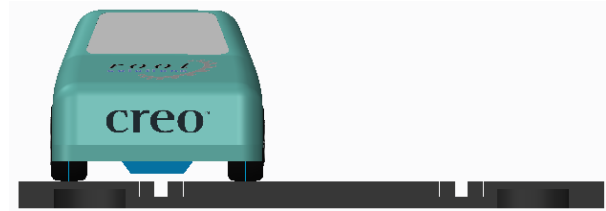

You will be looking at the front of the car sitting on a section of track.

3. Running an analysis:

- From the **Applications** tab, **Motion** group, select **Mechanism**.
- In the Mechanism tree on the left side of the screen, expand the **ANALYSES** sub-heading.
- Right click on **C_OF_G_TILT (DYNAMICS)** and, select **Run** from the pop-up menu.

The analysis applies gravity to the model and then runs the servo motor which tilts the track.

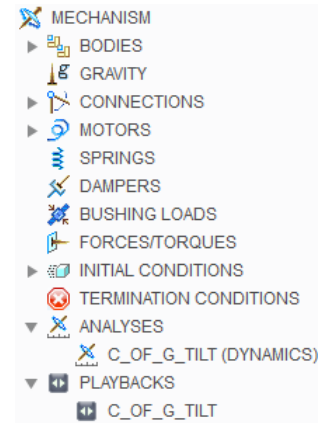

4. Play back the analysis

- Once the analysis has finished, expand the **PLAYBACKS** sub-heading.
- Right click on the **C_OF_G_TILT** playback feature and, select **Play** from the pop-up menu,.
- Use the **playback** controls to view the analysis.
- Pause the movement at the instant the car begins to tip.

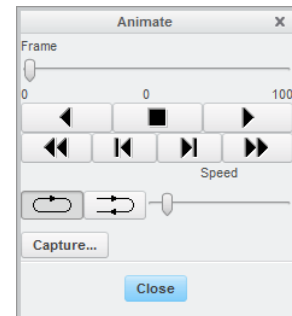



5. Taking measurements from the model:

- From the **Analysis** tab, Measure group, select **Angle** from the **Measure** drop-down menu.
- In the model tree click **ASM_TOP**, hold **Ctrl** and then select the underside of the track.



- Record the angle shown in the graphics area next to the track.

6. Close the model

- From the Quick Access toolbar, click Close .
- From the **Home** tab, **Data** group, click **Erase Not Displayed** .

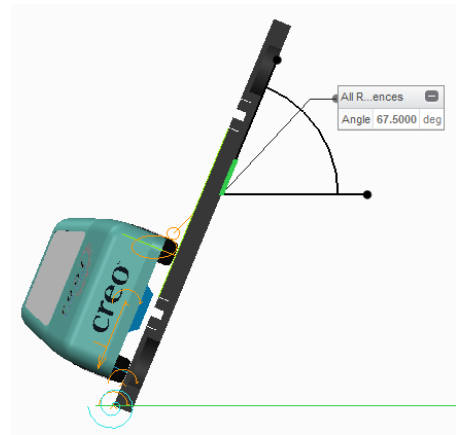

Task 4: Acceleration

1. Starting Creo and setting the working directory:

- If necessary, start **Creo Parametric**.
- From the **Home** tab, **Data** group, click **Select Working Directory**.
- Navigate to the folder **2013_S4S_Car**.
- Click **OK** to set the folder as the working directory.

2. Opening the analysis model:

- Open the assembly **ACCELERATION.ASM**.
- Zoom to view the model like this.

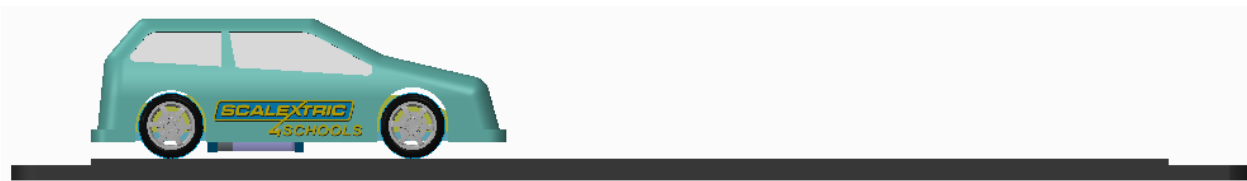

3. Running the analysis:

- From the **Applications** tab, **Motion** group select **Mechanism**.
- In the Mechanism tree, expand the **ANALYSES** sub-heading.
- Right click on **ACCELERATION (DYNAMICS)** and select **Run** from the pop-up menu.

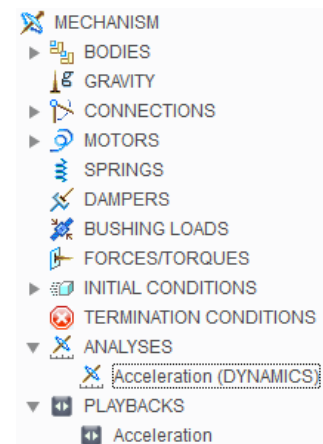

4. Playing back the analysis

- Once the analysis has finished, expand the **PLAYBACKS** sub-heading, right click the **ACCELERATION** feature and click **Play** from the pop-up menu.
- Use the **playback** controls to view the analysis.
- While the playback is running rotate and zoom the model to inspect the behavior more closely.

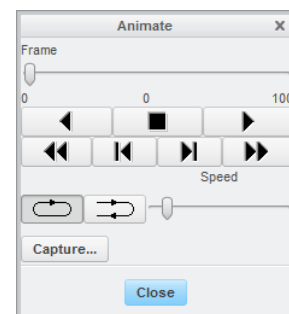

Task 5: Coefficient of friction

A cam connection links each of the rear wheels of the car to the track surface. These cam connections contain properties for coefficient of restitution and friction.

To make the analysis realistic it is important that the correct values are used for these properties. The next step is to find the coefficient of friction between the tires and the surface of the track.

Coefficient of friction is an empirical value and therefore can only be found by experiment. In the picture shown to the right, the car is being pulled along the track using a force meter.

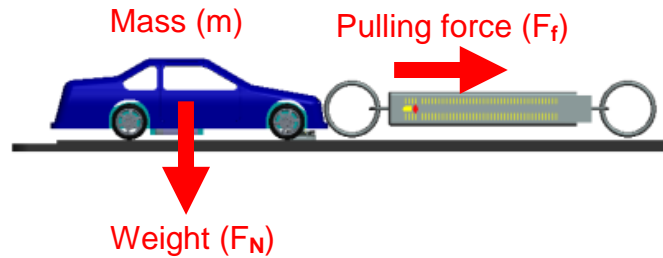

The experiment came up with a pulling force of 0.053 Newtons

Example

Mass of Slot car=0.085 kg
 Weight = Mass x gravity
 Weight = 0.085 x 9.81
 Weight (F_N) = 0.083 Newtons

Pulling force (F_f) = 0.053 Newtons

Coefficient of Friction (μ)

$$F_f = \mu \times F_N$$

$$0.053 = \mu \times 0.083$$

$$\frac{0.053}{0.083} = \mu$$

$$\underline{\underline{0.64 = \mu}}$$

Your calculations

Mass of Slot car= kg
 Weight = Mass x gravity
 Weight = x 9.81
 Weight (F_N) = Newtons

Pulling force (F_f) = Newtons

Coefficient of Friction (μ)

$$F_f = \mu \times F_N$$

$$= \mu \times$$

$$\underline{\quad\quad} = \mu$$

$$\underline{\underline{= \mu}}$$

Design guide: Increase tire friction, reduce bearing friction.

5. Changing the analysis

- In the mechanism tree, expand the **CONNECTIONS** sub-heading and then the **CAMS** sub-heading.
- Click on **Cam Follower 1 (ACCELERATION)** and, select **Edit Definition** from the pop-up menu.
- In the **Cam-Follower...** connection definition dialog box, click the **Properties** tab.
- Enter the value you have derived for coefficient of friction into the two fields shown outlined in red.

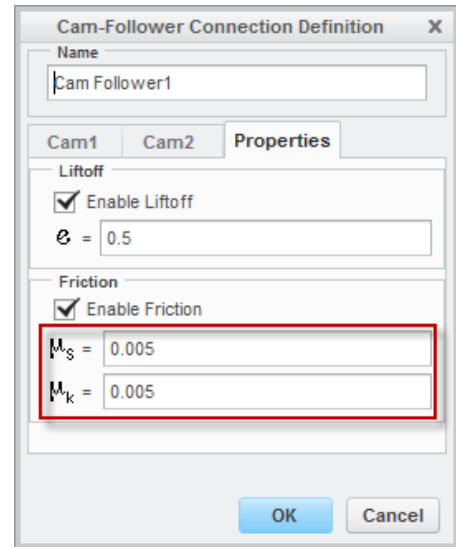

- Click **OK** to finish editing the cam follower connection definition.

6. Re-run the analysis.

- Run the **ACCELERATION (DYNAMICS)** analysis again and use the playback controls to examine the results of the new analysis.

7. Conclusions

- Explain any differences in the two analyses.

Design hint: Match gearing to each track. For example, you may want low gearing for acceleration on tight, twisty circuits or high gearing for high speed circuits.

Aim: The motor should be running at maximum rpm at fastest part of circuit.

Design guide: Tires with sharp edges are less likely to slide but may suddenly 'dig in' making the car roll out of the slot. A crashed car loses lots of time so enthusiasts radius the edges of the rear tires to stop them digging in allowing the car to slide or drift around corners.

Further analyses/simulations

Here are other analyses **Creo Parametric** would allow you to apply to your design.

- **Gearing** - Change the gear ratio and re-run the acceleration analysis.
- **Cornering static** – For C of G stability but with the tires free to slip on the track surface.
- **Cornering dynamic** – All points of contact assembly connection allows the slot guide to release and shows the car tumbling off the track. See video [Scalextric4Schools-W5.wmv](#)

- **Hill climb** – For acceleration but with the track at increasing angles until the driving wheels spin or the car tips over backwards.



Setting up analyses from scratch is an advanced technique. Detailed guidance can be found in Precision LMS courses on mechanism dynamics.

Teachers and instructors using **Creo Parametric** can register to use PTC University – Precision LMS, a comprehensive range of online tutorials covering most of the features in this software.

Once registered, your instructor can allow students to access the materials.

This is an excellent way for you to learn **Creo Parametric** from the professionals.

The screenshot shows a web browser window titled 'Course Viewer: Mechanism Simulation using Creo Parametric - Windows Internet Explorer provided by IT GDS'. The page content includes:

- Navigation buttons: Hide Course Map, Fit view, Exercise Mode, Add Bookmark, Email, and back/forward arrows.
- Expand/Collapse All controls.
- Audio player: 'Click below to listen to the audio version (03:34):' with a progress bar from 00:00 to 03:34.
- Section heading: **Concept: Applying Friction and Restitution**
- Sub-heading: **Applying Friction and Restitution**
- Text: 'The Mechanism Dynamics Option (MDO) enables you to define friction and restitution properties for connections. You enable the restitution and friction in connections by selecting Dynamic Properties from the Motion Axis dialog box. Cam-Follower connections, however, are enabled on the Properties tab of the Cam-Follower Definition dialog box.'
- Diagram: A blue curved track with two grey diamond-shaped components on it.
- Caption: 'Figure 1 – Friction Causes the Component to Roll, Not Slide'

Each unit of material is organized into

- **Concept** – The learning goals of the unit including animated images and audio-visual presentation.
- **Demonstration** – An on-screen video recording with commentary by an expert user of **Creo Parametric**. This can be paused and replayed as often as you like. Where appropriate there are **Creo Parametric** files you can download and work with alongside the tutorials.
- **Procedure** – Step by step text tutorial with animated illustrations explaining every action, dialog box and menu picks.

Homework

Have you ever thought about industrial designer as a career and what you would have to study to become one? Read how Victoria became a designer, the subjects she studied at school and the work she did at university to land a job at Hornby designing the Scalextric cars you can buy in toy stores around the world.

Session eight: Presentation preparation

Outline

By the end of this session you will have started creating an electronic presentation showing how your design was developed. Make sure you structure your presentation with evidence for all sections in the competition rules.

To help you we will show you how to convert your body mold into a body shell and add it to an assembly. Rendering the finished car will provide one of the images you will need for your presentation.

Starter

Your teacher will ask you questions about the career of product designer and the education route to become one.

Task 1: CAD modeling the vacuum formed body

Outline

Adding features to convert the body mold into a body shell is straightforward and involves re-instating the model tree and making changes to the order of features

Convert mold to body shell

Expert/Overview

The following section will teach you how to convert the body mold into a body shell. This involves:

- Moving the ➔**Insert here** flag above the mirror feature.
- Shelling the half mold **outside** by 2 mm with the underside and center faces removed.
- Move the ➔**Insert here** flag to the bottom of the model tree.

The result will be a body shell representing the vacuum formed component needed to complete the assembly.

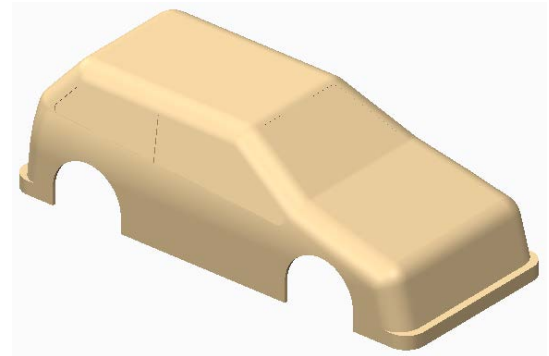
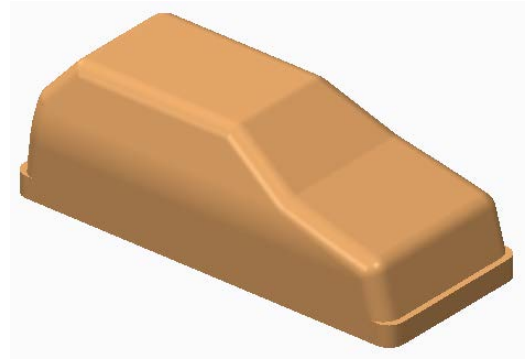



After adding features to convert your mold into a body, at any time can switch between the two by suppressing additional features as shown below.

Model tree

- BODY_RENDER.PRT
 - FRONT
 - TOP
 - RIGHT
 - DEFAULT_CSYS
 - ▶ □ CHASSIS_BASE
 - ▶ □ BODY_PROFILE
 - ▶ □ Extrude 1
 - ▶ Round 1
 - ▶ Round 2
 - ▶ Round 3
 - ▶ Round 4
 - Shell 1
 - WHEEL_ARCHES
 - WINDSCREEN
 - REAR_WINDOW
 - SIDE_WINDOWS
 - Sketch 2
 - Project 2
 - Sweep 1
 - Mirror 1
 - ▶ Insert Here

Suppressed Features

Model view

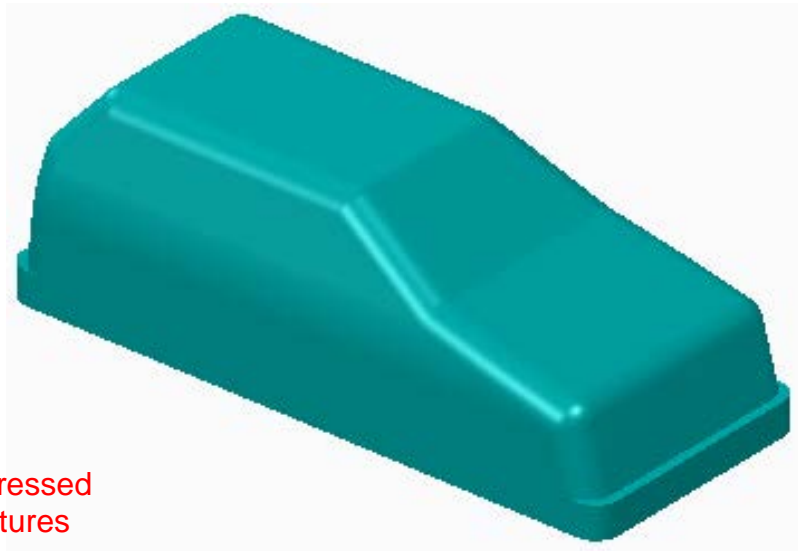

- BODY_RENDER.PRT
 - FRONT
 - TOP
 - RIGHT
 - DEFAULT_CSYS
 - ▶ □ CHASSIS_BASE
 - ▶ □ BODY_PROFILE
 - ▶ □ Extrude 1
 - ▶ Round 1
 - ▶ Round 2
 - ▶ Round 3
 - ▶ Round 4
 - Shell 1
 - ▶ □ WHEEL_ARCHES
 - ▶ □ WINDSCREEN
 - ▶ □ REAR_WINDOW
 - ▶ □ SIDE_WINDOWS
 - Sketch 2
 - ▶ Project 2
 - ▶ Sweep 1
 - Mirror 1
 - ▶ Insert Here

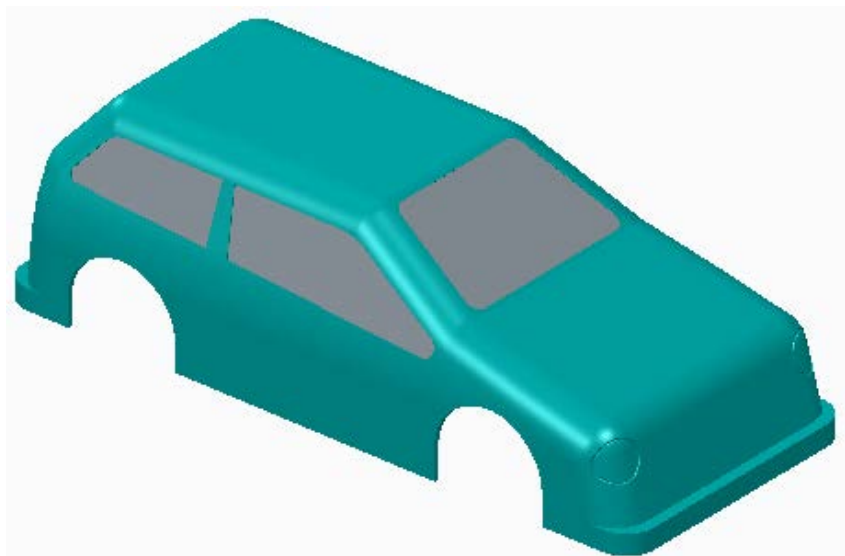

Step by Step

1. Getting started.

- If necessary, start **Creo Parametric**.
- Set the **Working Directory** to where your Scalextric4Schools models are stored.

2. Making a copy of your mold part

- **Open** the body mold you created previously.
- Click **File > Save As > Save a Copy**.
- In the Save a Copy dialog box, New Name field, type **BODY_SHELL.PRT** and click **OK**.
- Close **BODY.PRT**
- **Erase Not Displayed**
- Open **BODYSHELL.PRT**.

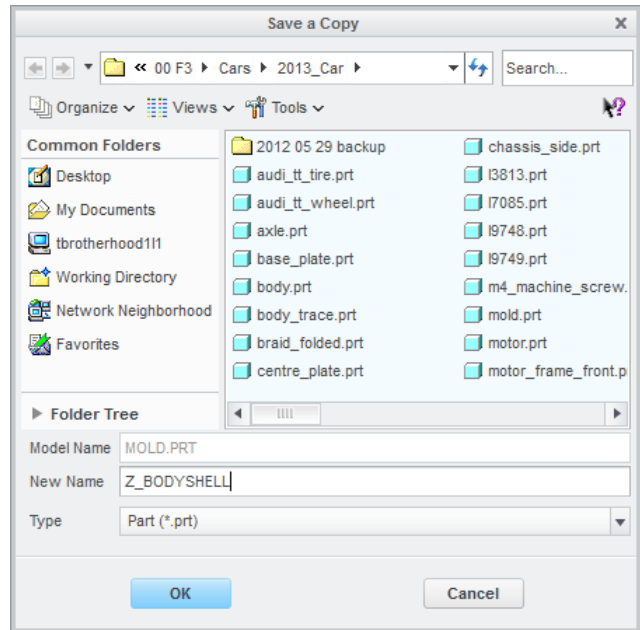

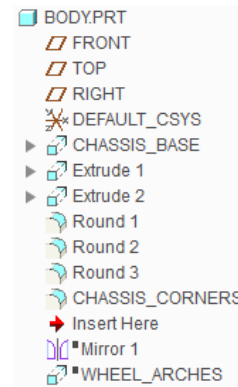
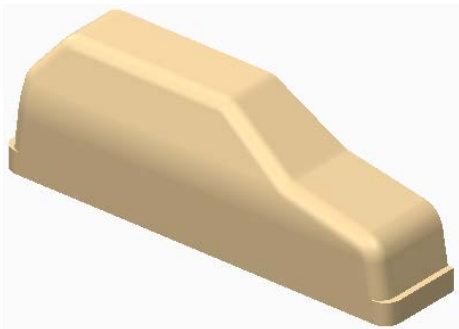

3. Moving the “Insert Here” flag:

- In the model tree, drag the **➔Insert here** flag above the mirror feature.



4. Adding a shell feature:

- From the **Model** tab, **Engineering** group, click **Shell** .
- In the **Shell** tab, change the **Thickness X1** to **2** and click **X2 Change Direction** , to shell the model externally.



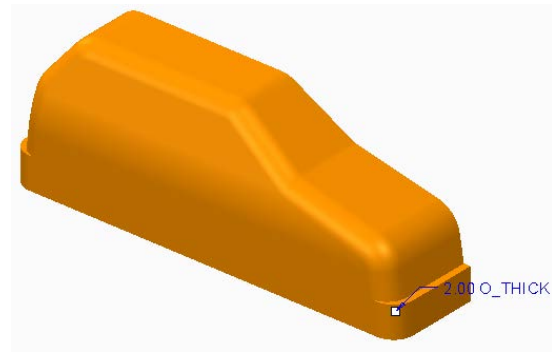

When the shell is external, the orange preview will be visible outside the model.

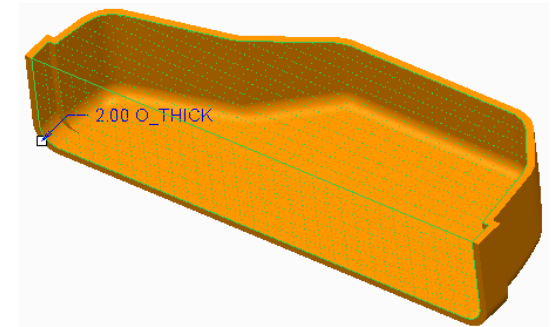

- Rotate the model so you can see the center and bottom faces.
- Hold **CTRL** and select the bottom and center faces of the model.

These surfaces will be shown removed from the shelled shape.



- In the Shell tab click **Complete Feature** .

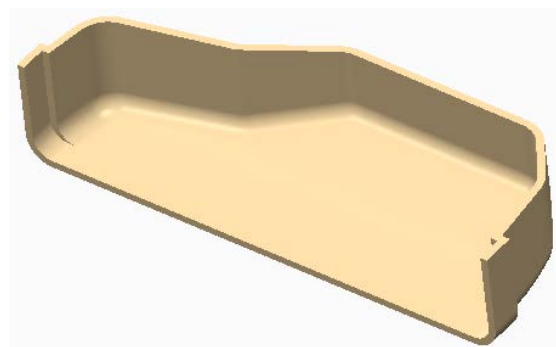

5. Move the “Insert Here” flag to reinstate features.
 - In the model tree, drag the **➔Insert Here** flag to the bottom of the model tree.

This reinstates the features in the model.

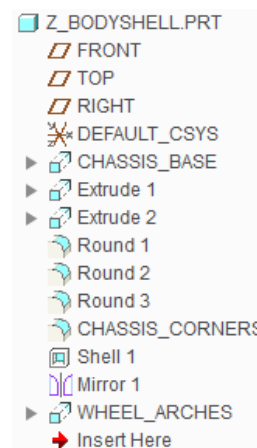

The model will regenerate, mirroring the extra features. You should now have a symmetrical car body with wheel arches.

- **Save** your model.

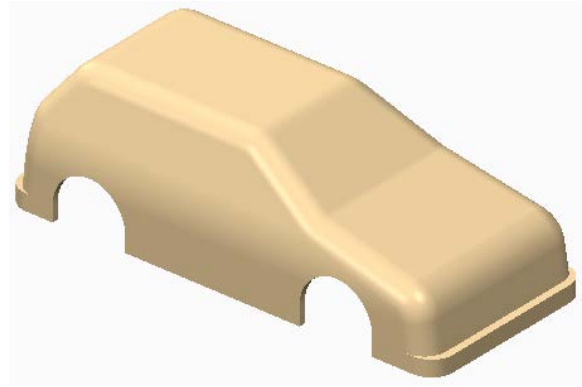

Task 2: Part properties

While the shape of the body is complete, we still need to record other details to form a complete description of the part including a description, the project it forms part of, who created it and the material it is made of.

1. Applying material properties

- Click **File > Prepare > Properties.**
- Next to the **Materials** entry, click **change**.

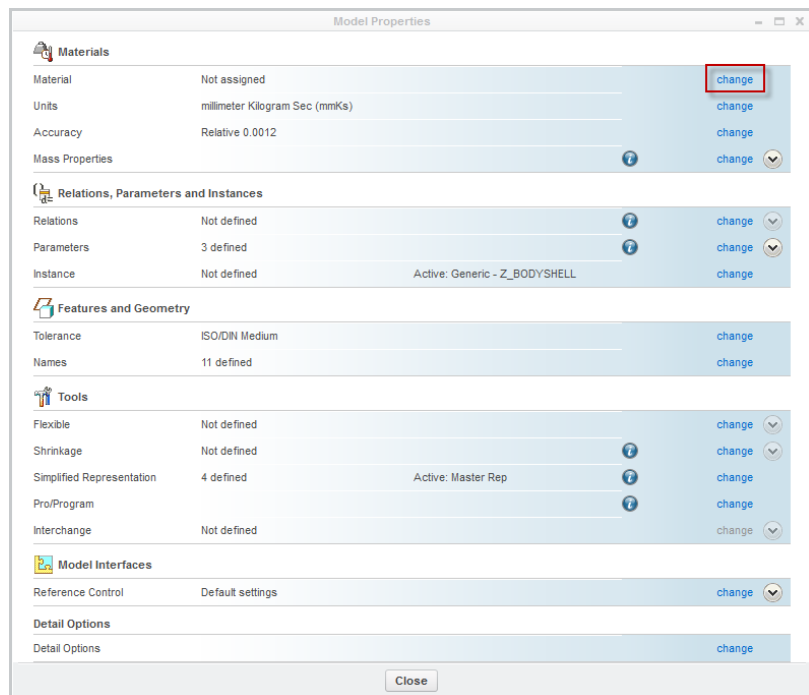

- In Materials dialog box, select **Plastic_HIPS** and click **Assign** ▶▶▶
- If you see a message asking if you want to convert units, click OK.
- Click **OK** in the Materials dialog box to close it.

Creo Parametric has applied this material to the body.

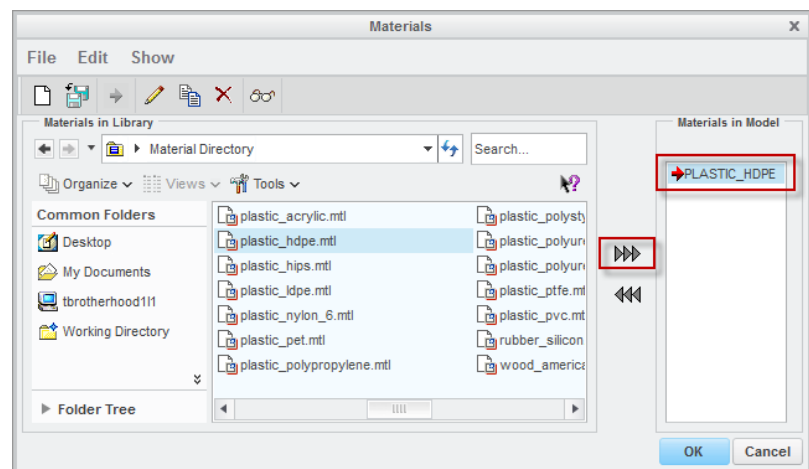

For accurate analysis you should research the properties of actual vacuum forming sheets you will be using, create a new material definition and apply this to your model.

Part properties

The next step is to assign non-geometric parameters to the part.

The Model Properties dialog box should still be open.

2. Adding text parameters

- Next to **Parameters** click **Change**.
- In the Parameter dialog box, fill in the values for **DESCRIPTION**, **PROJECT** and **MODELLED_BY**.
- Click **OK** in the Parameters dialog box.
- In the Model Properties dialog box, click **Close**.
- **Save** your model and close the window.

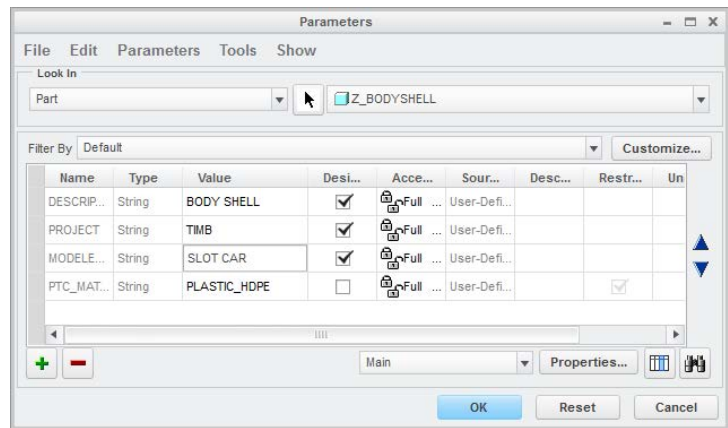

the material parameter has been entered automatically.

You should now be comfortable using **Creo Parametric** to model a body shape ready for when you design your own car shape.

Task 3: Add body shell to the assembly

1. Getting started:

- Open the model **2013_S4S_HATCH.ASM**
- **Hide** any mold or body components that may be visible.

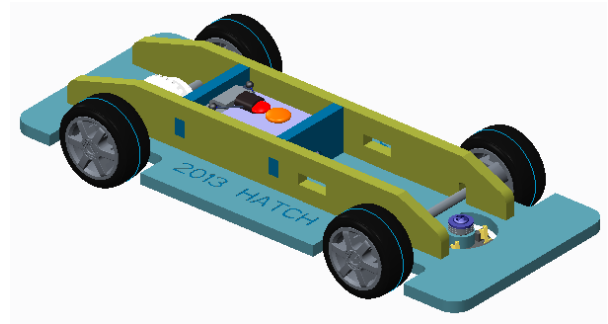

2. Adding a new component to the assembly:

- From the **Model** tab, **Component** group, click **Assemble**  to add a new part.
- In the Open dialog box select **BODYSHELL.PRT** and click **Open**.

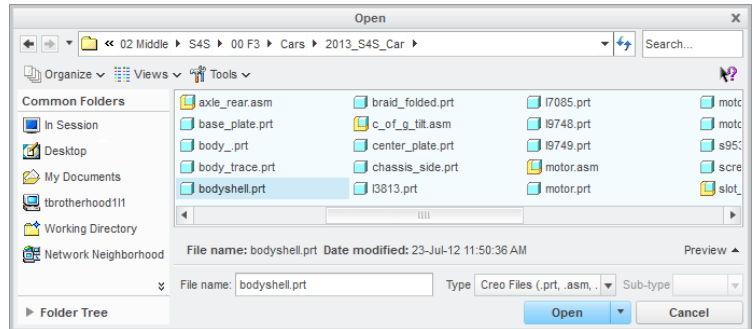

The part will appear in the model window attached to your cursor.

- Move the mouse until the body shell is close to where it needs to be placed.
- Click to place the part temporarily.

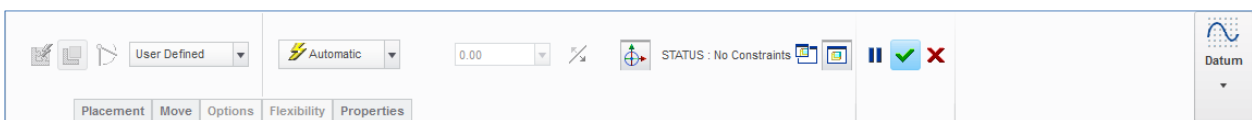

The mouse cursor will be released from the part and the 3D Dragger will appear.

If the body is not close to its final position, use the dragger arrows to move it close but with a small gap as shown here.

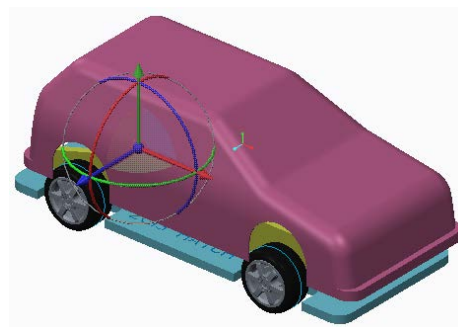

Three pairs of surfaces will each be linked with a **Coincident** assembly constraint.

3. Create the first assembly constraint:
 - Click to select the top surface of the chassis base at **X1**.
 - Click the inside surface of the front step on the body at **X2**.

As the mate constraint is applied, the body will move until the selected surfaces are coincident.

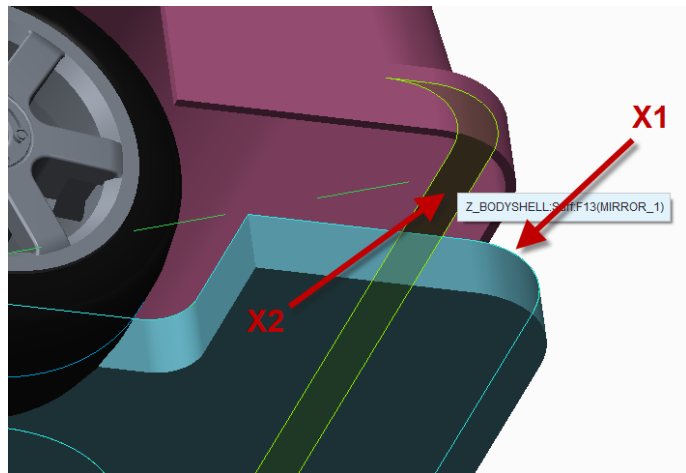

4. Create a second assembly constraint
 - Use the Dragger to move the body shell slightly forward of its final position.
 - Select the front face of the chassis at **X1**.
 - Select the vertical face inside the front of the body at **X2**.

The body will move rearwards to mate the two surfaces creating another Coincident constraint.

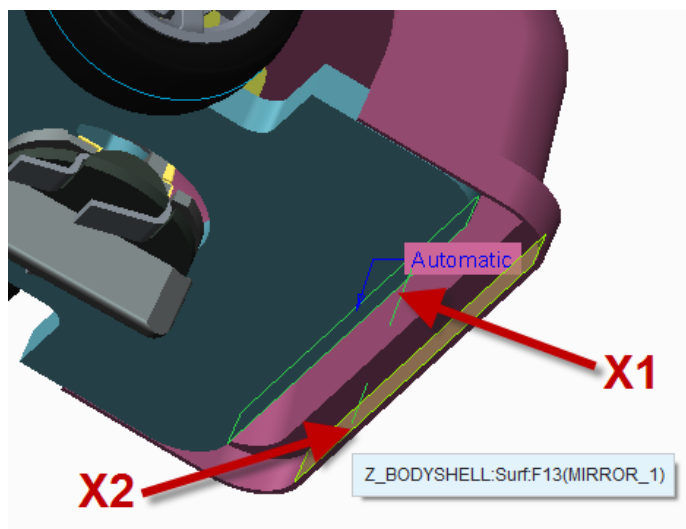

5. Adding a third assembly constraint.
 - Use dragger to move the body to the side, leaving a gap so that it is easier to select the final pair of surfaces.
 - Select the side of the chassis at **X1**.
 - Select the inside face of the body side at **X2**.

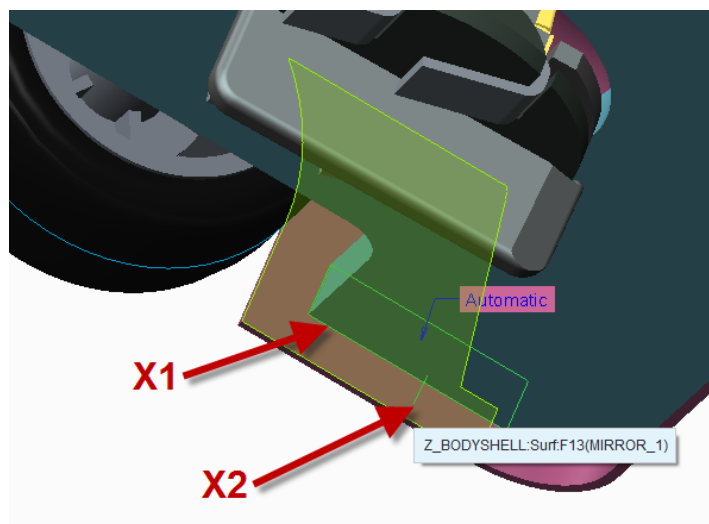

The body will move sideways and change to a yellow color to show that it is now **Fully Constrained**.

Labels show the type and position of the assembly constraints.

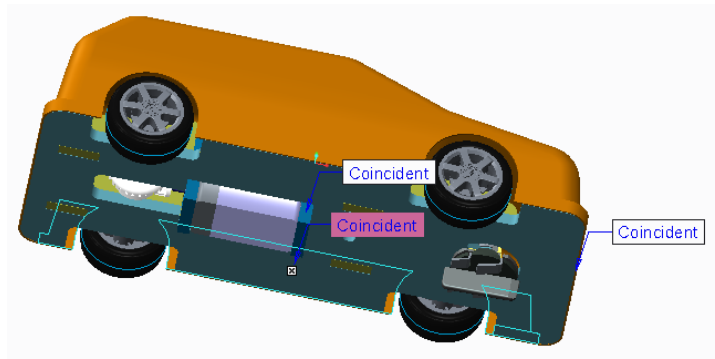

The Placement tab at the bottom edge of the Assembly dashboard is where the constraints and surface selections are recorded. You can edit the constraints in the Placement tab.

- In the assembly dashboard, click **Complete Assembly** ✓ to finish adding the body to the assembly.
- **Save** your model, **Close** the Window and **Erase Not Displayed**.

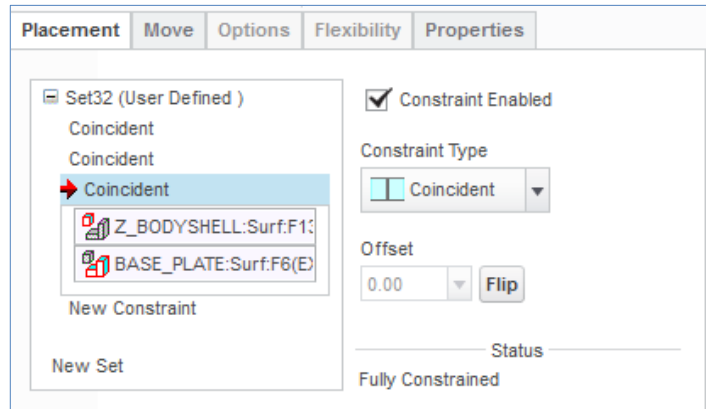

Extensions

By creating additional features, you can make your model more realistic.

Extrude sketches a small depth removing material to create recesses for windows.



Project a sketch onto the car surfaces and then “Sweep” a small circle along the projected spline.

This technique has been used here to create a “shut” line around the headlight.



Homework six - Industrial designer

The job of product designer is well paid and varied. If you would like to know more about becoming a designer you may be interested in the story of Victoria, one of the Scalextric designers. Her story is in the ‘Design Guide’ for this project.

Session nine: Visualizing

Creo Parametric has a wide range of powerful tools for presenting your design.

Rendered CAD model

Creo Parametric is supplied with a set of fully featured rendering tools allowing you to create a photo-realistic image of your design.

In this section you will be taught how to apply textures and graphics to parts and present them as finished image.



Key principles

The **Advanced Rendering Extension** (ARX) module in **Creo Parametric** is very powerful with many adjustments to the room environment such as materials, lighting and reflections possible.

This session will provide a brief overview and hands-on experience of just a few features, enough to produce a final rendered image of your slot car assembly.

The sequence you will work through is:

- Apply an appearance to the surface of your car body
- Apply a logo graphic to surfaces on your car body
- Open your slot car assembly
- Define initial render settings
- Load a scene definition
- Position the model in the room
- Change the view of your model
- Try a draft render
- Make any adjustments.
- Perform the final render
- Save the rendered image



Making changes to the features of a model that has appearances and decals applied can lose them. Delay rendering your model until you are happy it won't need any changes to the shape.

Task 1: Applying textures

Applying appearances is very straightforward and **Creo Parametric** comes with a comprehensive library of material appearances.

1. Getting started:

- If necessary, start **Creo Parametric**
- Open **BODYSHELL.PRT**.

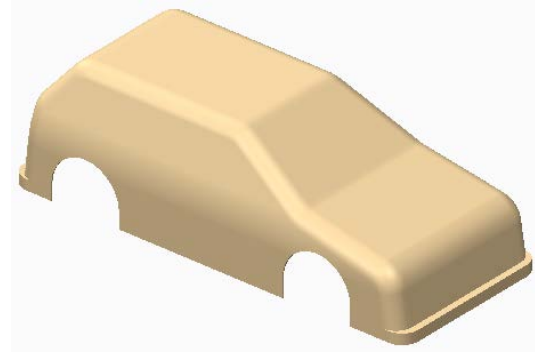

2. Applying an appearance to the model.

- From the **Render** tab, **Appearance** group, open the **Appearance Gallery** drop-down menu.
- In the **Library** section **X1**, select a category of material appearances.

To the right, a library of spray painted textures is shown.

- In the **library** section of the **Appearance Gallery** drop-down menu, click **ADV-PAINT-SPRAY.DMT** at **X2** to open the list of spray painted appearances.
- Select one of the colors shown in the **Library** section.

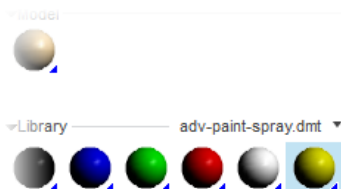

When a selection is made, the drop down menu will close, the mouse cursor will change to a paintbrush and, the **Select** dialog box will open in the top right of the screen.

- Select **BODYSHELL.PRT** at the top of the model tree.
- You can either middle-click or, click **OK** in the **Select** dialog box to finish applying the appearance.

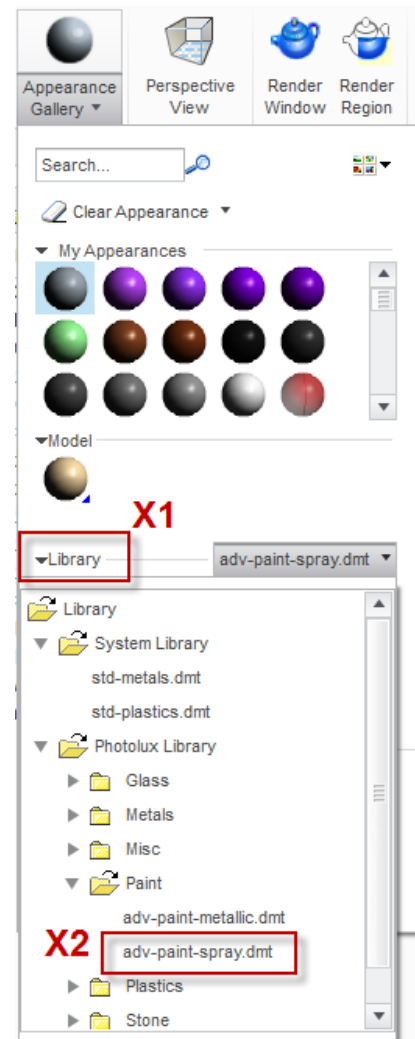

The model will be colored with the new appearance on all surfaces.

- **Save** your model, **Close** the Window and **Erase Not Displayed**.

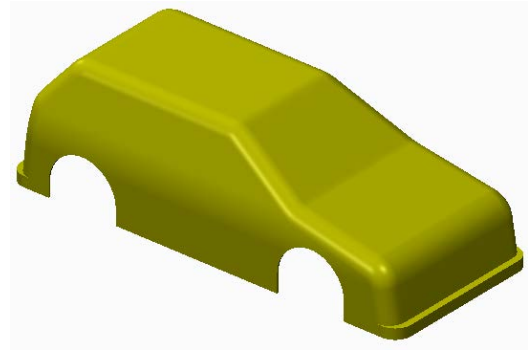

Task 2: Sponsorship and logos

In motor sport it is common to sell advertising space on cars. The cost to sponsors depends on how visible the spaces are to spectators and TV coverage. Which surfaces of your car do you think will be worth the most?

The following organizations already sponsor this challenge with curriculum, branding and resources. The competition rules dictate you must have their logos on your car at the sizes shown.

Global sponsors



16mm x 6mm



18mm x 4mm



12mm x 8mm

Regional sponsors – UK



10mm x 10mm



12mm x 14mm



18mm x 5mm



18mm x 8mm



18mm x 9mm



18mm x 5mm

Regional sponsors - Australia



12mm x 12mm



HOLDEN

12mm x 12mm



10mm x 14mm



12mm x 8mm



13mm x 7mm

Regional sponsors – North America

Add here

12mm x 12mm

Add here

12mm x 12mm

Are they all the same size? The logos are all different proportions so how would you measure the amount of space each one has. Would you include the white spaces?

What mathematical techniques could you use to measure the area of each logo?

Sponsors will want proof their logos are the correct size.

Creating a decal from a logo

Where logos are not rectangular it's important to make the background color transparent. In this example the white background obscures the teal color on the body.

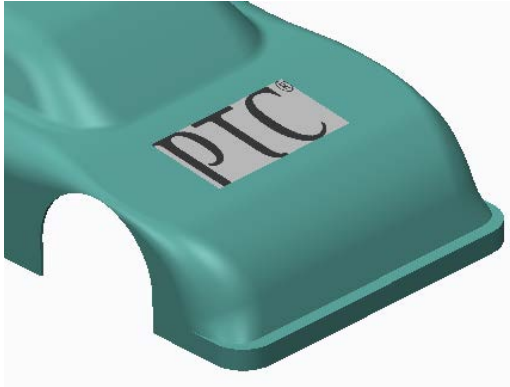

You will need a bit map file of an image with an alpha channel layer of the masked area. A guide to editing an image using Paint Shop Pro is available at:

<http://www.axialis.com/tutorials/tutorial-misc002.html>

This example uses a PNG format image of the PTC Logo.

PTC®



After conversion, the surrounding 'transparent' or masked area is shown as a checker board in the editing software.

The checker board pattern shows where the transparency will apply around the lettering.

Two versions of the PTC logo are available for you to practice with

- **PTC_LOGO_ON_WHITE.PNG**
- **PTC_LOGO_GRAY_ALPHA.PNG**

Task 3: Applying a decal

Expert/Overview

Applying a decal to a model is straightforward.

- A material texture is applied to the model.
- A copy of the material texture is made and the decal applied to this copy.
- The new material texture with the decal is applied to selected surfaces on the model.
- The decal placement is altered to rotate and position the decal.

1. Getting started

- Start **Creo Parametric**.
- **Set Working Directory** to where your models are saved.
- Open **BODYSHELL.PRT**.
- If it is needed, a file named **BODY_RENDER.PRT** is available for this exercise.

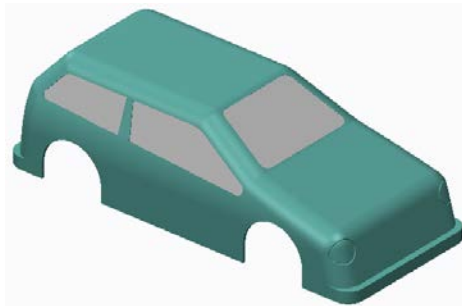

One of the standard **Creo Parametric** textures has been applied to the body and the default gray textures to the windows.

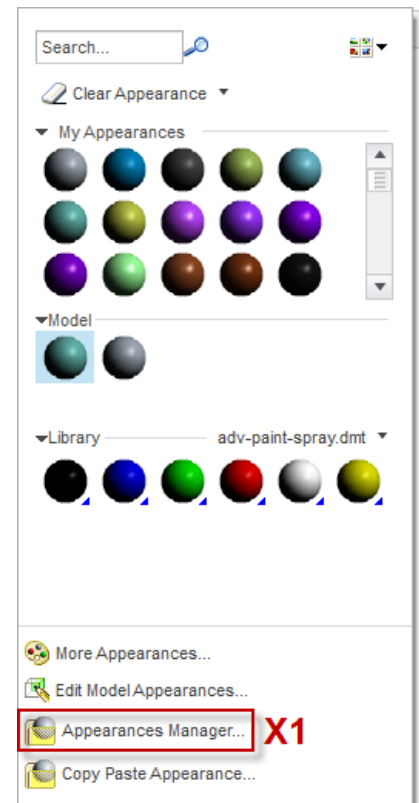

2. From the **Render** tab, **Appearance group**, open the **Appearance Gallery** drop-down list and click **Appearances Manager** at **X1**.

Appearances Manager is where you add, delete and modify material appearances for your model. You will make a copy of the texture that has been applied to the model then add a bit map image to the new texture.

The **Model** section of the dialog box lists the materials that have already been applied to the model.

3. Making a copy of a texture

- Right click on the Teal model appearance at **X1** and, click **Copy to My Appearances** from the drop-down menu.

The new material will be listed in the My Appearances section.

- Right click on the new appearance and click **New** from the pop-up menu.

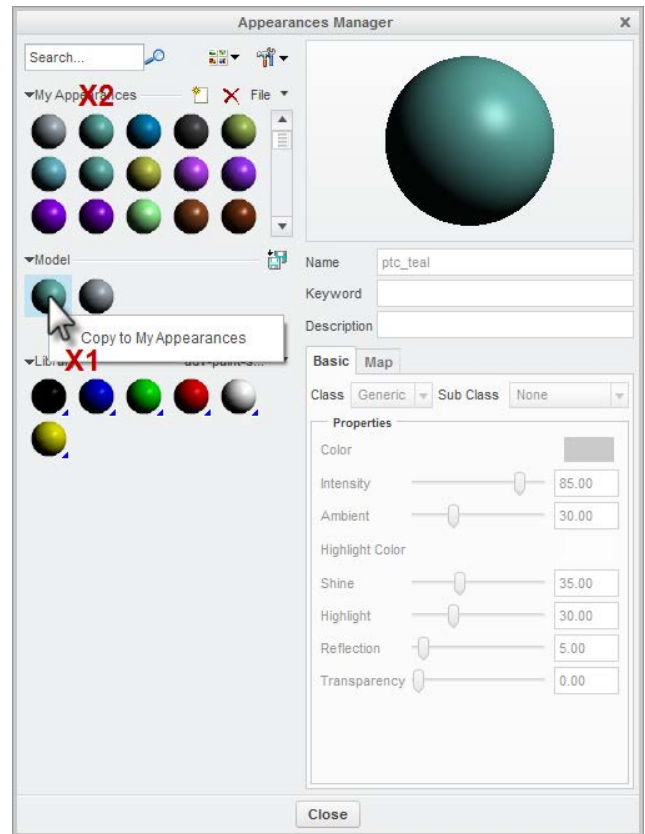
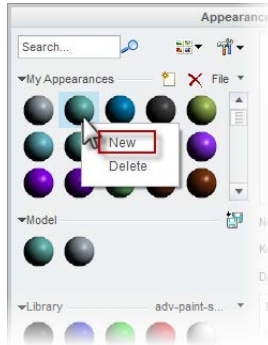

- Type a new name at **X1** for the material using a name which identifies the parent texture and the decal used.

4. Adding a decal

- Click to open the **Map** tab.
- In the **Decal** drop-down list at **X2** select **Image**.
- Click on the white square at **X3**.
- In the **Open** dialog box, Common Folders list, click **Working Directory** and from the list of files, select **PTC_LOGO_APLPHA.png**.
- Click **Open**.

5. Saving Appearances

You must save the new list of appearances to make sure the new texture is available next time the model is opened.

- In the Appearances Manager, click **File > Save As...**
- From the **Common Folders list** select

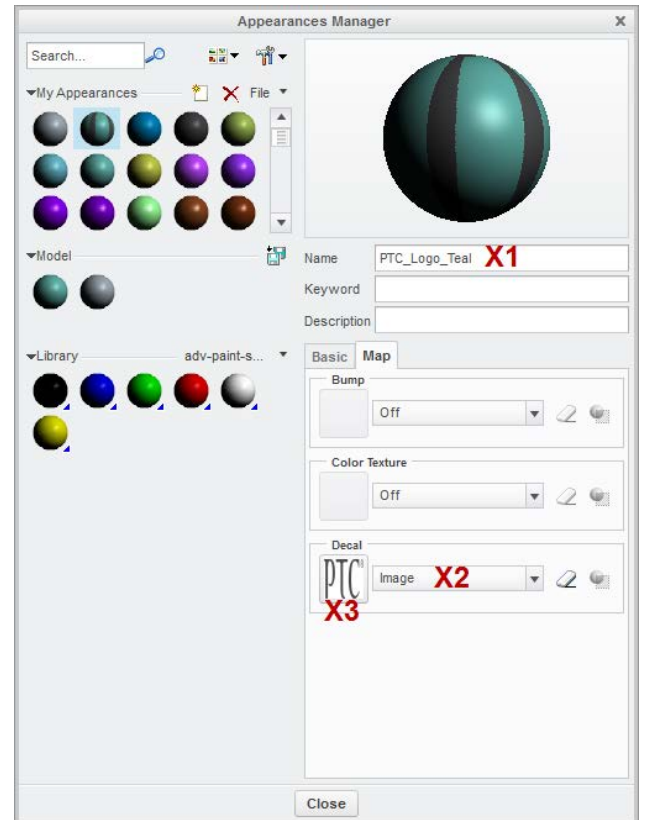

Working Directory and click **OK**.

- In the Save dialog box, click to select the **Working Directory** then click **OK** to save the list of appearances in the model.
- **Close** the Appearance Manager.

The appearance with the PTC logo can now be applied wherever the decal is required.

6. Apply the new decal texture

- From the Render tab, open the **Appearance Gallery** and select the texture with the logo you just created.

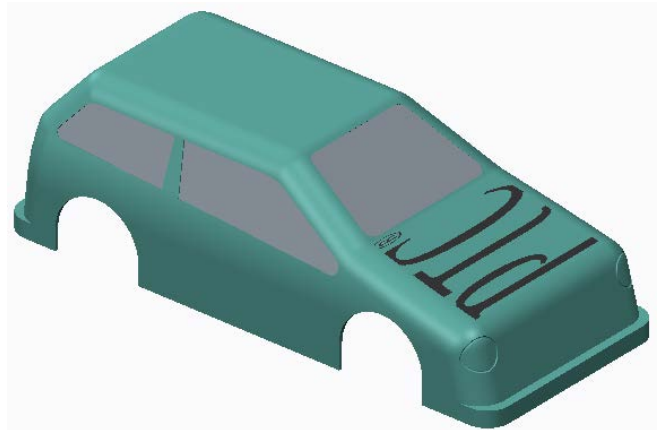

The Appearance Gallery will close automatically and the screen cursor changes to a paint brush.

- Move the mouse cursor over the surface you want the logo to appear on and click to select it.
- Middle click to finish applying the appearance to the model.
- **Save** your model.



When an appearance with decal is first applied to the model it is highly unlikely it will be scaled or positioned correctly. **Creo Parametric** provides tools to refine the size and orientation of decals.

7. Scale and position the decal

- Open the **Appearance Gallery** drop-down menu.
- Click **Edit Model Appearances**.
- Near the top of the dialog box at **X1**, click on the Eye Dropper  and use it to select the decal surface to be edited.
- In the Model Appearance Editor dialog box, click on the **Map** tab.
- In the **Decal** section click on  at **X3** to open the **Edit Decal Placement** dialog box.

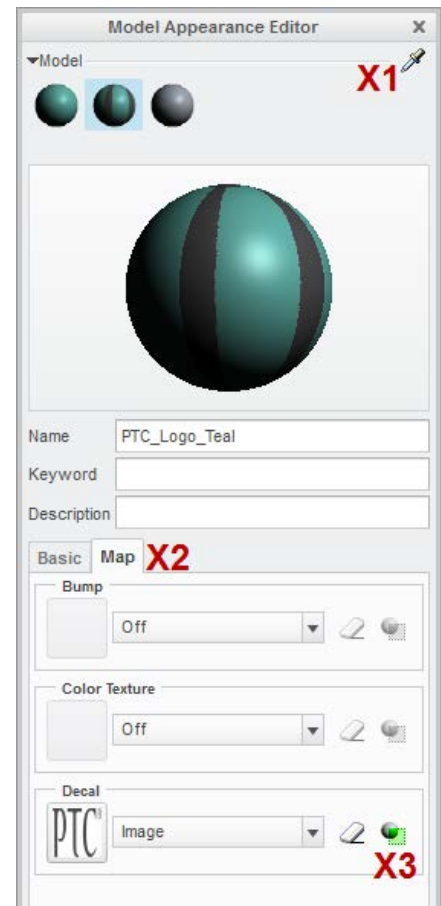

- In the Edit Decal placement dialog box, **Copies** section, select **Single** **X1**.
- Use the **Repeat** spin wheels at **X2** to scale the decal and the **Position** spin wheels at **X3** to move and/or rotate the decal.
- When you are happy with the decal placement, click **OK** in the Decal Placement dialog box and click **Close** in the Model Appearances Editor dialog box.

8. Repeat the scale and position steps on each decal surface.

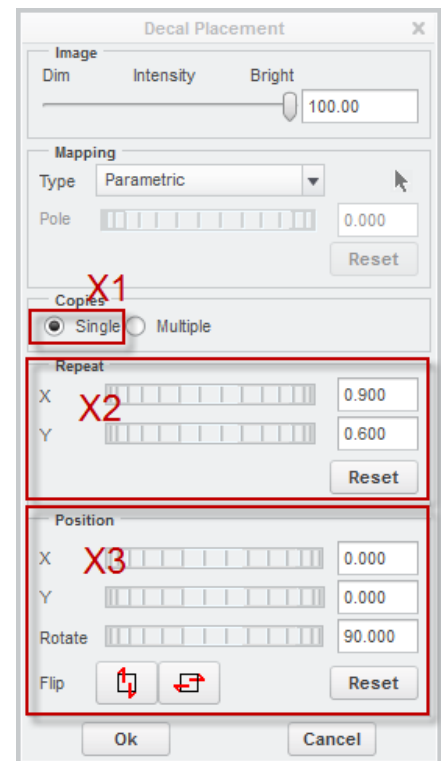

9. **Save** the model.

Task 4: Final render

1. Getting started.

- If necessary, start **Creo Parametric**.
- Set the working directory to where you files are stored.
- Open **2013_S4S_HATCH.ASM**.

2. Adding a scene

- From the **Render** tab, **Scene** group, click **Scene** .
- In the Scenes dialog box, scroll in the **Scene Gallery** section to find the **photonux-studio-hard** scene and double click to apply it to the model.
- Select the **Save scene with model** option **X1**

A 'Scene' stores information about several aspects of the render including the size and shape of the room, textures on room surfaces, lighting and special effects.

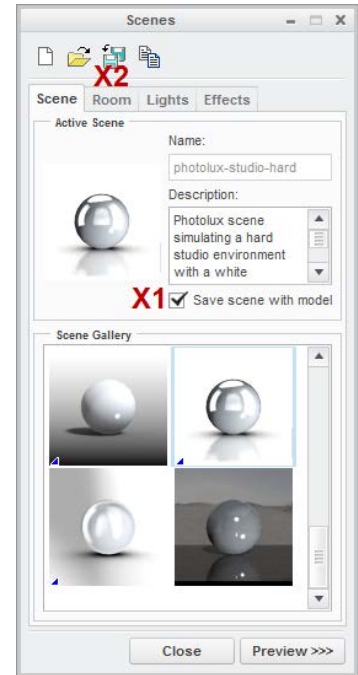

3. Aligning the floor with the model.

- In the Scenes dialog box, select the **Room** tab at **X2**.
- Click on **Align Floor**  at **X1** to snap the floor to the model.

If you rotate the model you will see the floor has attached itself to the bottom of the slot guide. We want it to be just touching the wheels.

- Drag the **Floor** spin wheel at **X2** to move the floor up. If needed, type in numbers for fine adjustment.

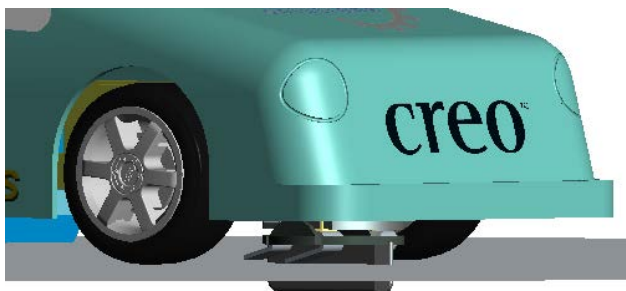

- Click **Close** to finish with the Scenes dialog box.

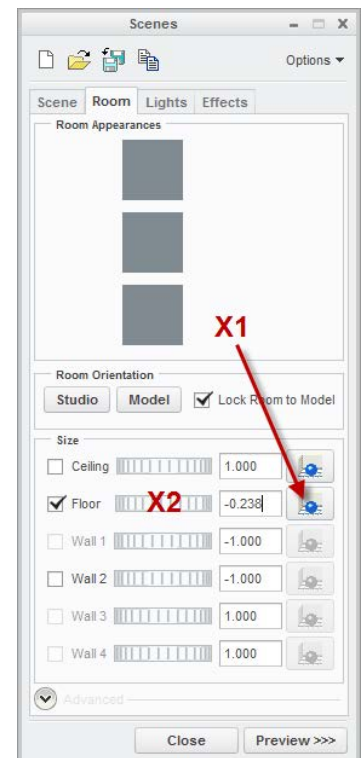

4. Adding perspective

- From the **Render** tab, **Perspective** group click **Perspective** .
- Click the small arrow next to the Perspective group and select **Perspective Settings** from the drop-down menu.
- Move the **Eye Distance** slider to see how this changes the amount of perspective.
- When you are satisfied with the perspective settings, click **OK** to close the Perspective dialog box.

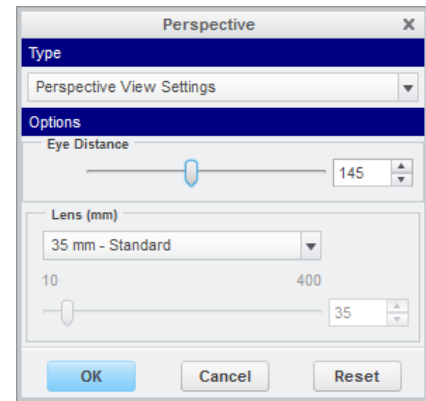

Photographers will recognize the effect which is similar to the distortion caused by lenses of different focal length.

5. Positioning the model:

- Spin and zoom the model to position the car how you want to see it.

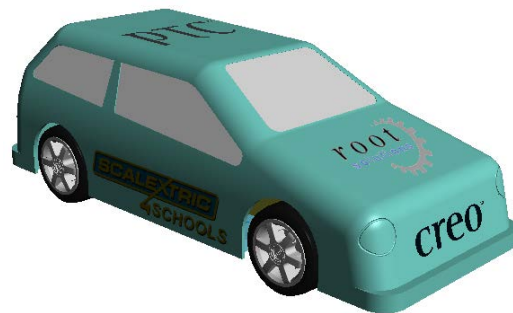

6. Quick render:

- From the **Render** tab, Render group select **Render Window** .

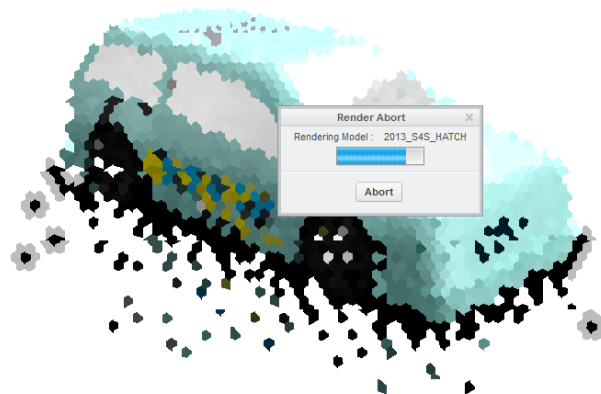

Why do you think a tea pot has been used for this tool?

Depending on the speed of your PC, the render may take a little while.

7. Higher quality render:

- When you are happy with the overall appearance of your model, click **Render Setup**  and change the **Quality** to **Maximum**.
- Close the Render Setup dialog box and render the model again.

This may take some time but the result should be much more realistic.

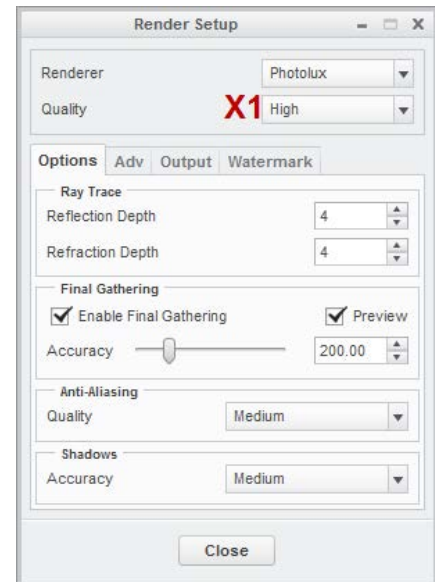
**Try out different settings.**

Here the Scene was changed to **Photolux-studio_soft**, the **floor** was reset to the bottom of the tires and the quality was increased to **maximum**.

If you want to find out more about render settings your teacher has access to a more detailed guide.



Graphic design

Professional racing teams have full-time designers working on car graphics, promotional materials and branding.

The base color schemes on full scale cars is spray painted.

Company logos, text and images are then applied using vinyl decals/stickers.



Many schools have computer controlled vinyl cutters.

This would work fine for go-faster stripes and large text but fine detail is not easy to create and apply using knife cut vinyl.

Water -slide transfer material is ideal for putting detail on your car bodies. Simply print your graphics on the sheet, cut round the graphic, soak in warm water, then slide the graphic on to the model.

It works best on flat surfaces or ones with a single curvature.

Available from Magic Touch -

<http://www.themagictouch.co.uk/transfer/dct.htm>



Session ten: Races

Track

The Scalextric4Schools track layout was designed specifically by Scalextric with tight curves and fast straights to test cars and drivers to the limit.

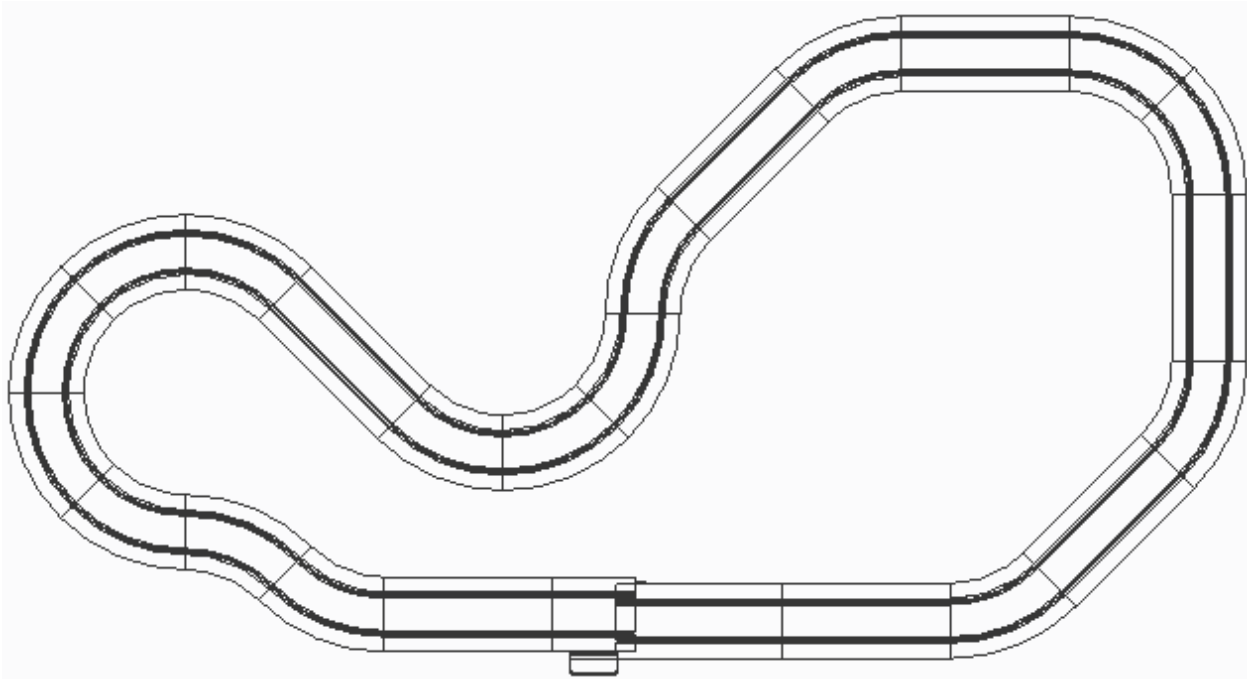

The track pack comes with two speed controllers and a power supply can be purchased online with education discount. www.scalextric4schools.org.

A Creo Parametric model of the Challenge track layout is available to download on the challenge web site.

You can also download the track design in the format used by Scalextric 'Track Designer' software.

Scalextric 'Track Designer' software can be downloaded free from the Scalextric web site at www.scalextric.com.

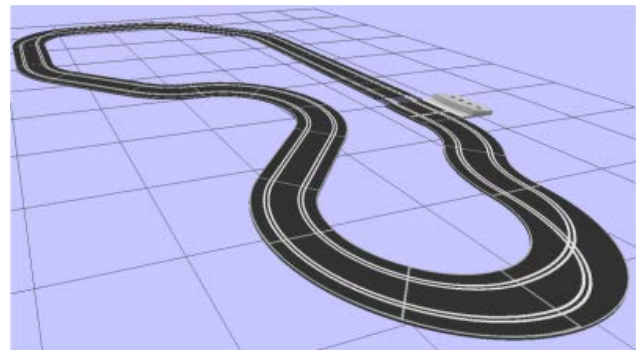

When testing your cars, make sure you carry out 'fair tests'. Your instructor/teacher will be able to explain this and help you use testing to identify aspects of your design you could modify and improve.

In certain regions competitions will be organized by PTC, Scalextric or their partners using the Scalextric4Schools 'Sport' track layout.

Session eleven: Presentation

This is an opportunity for your team to present the story of your design, how it developed and how well it performs.

Good luck!

Appendix: Car design template

