

PTC[®] presents

ROBOTalk

Hosted by David Price, the voice of FTC

How to build a
robot from
concept to
competition

September 17th, 2014

WELCOME

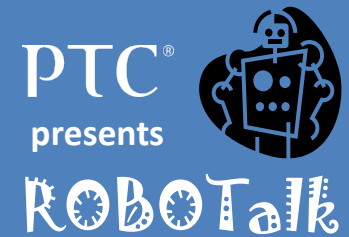

- Thank You for joining us!
- PTC Experts on this webinar



Jordan Cox
Director, PTC K12
Programs



Scott Morris
Windchill & Creo
Expert



Mark Cheli
Creo Expert &
Webex Technical
Assistance



Todd Kraft
Creo & Mathcad
Expert



**Kari
Karwedsky**
PTC FIRST
Program Manager

- Our new host,

David Price



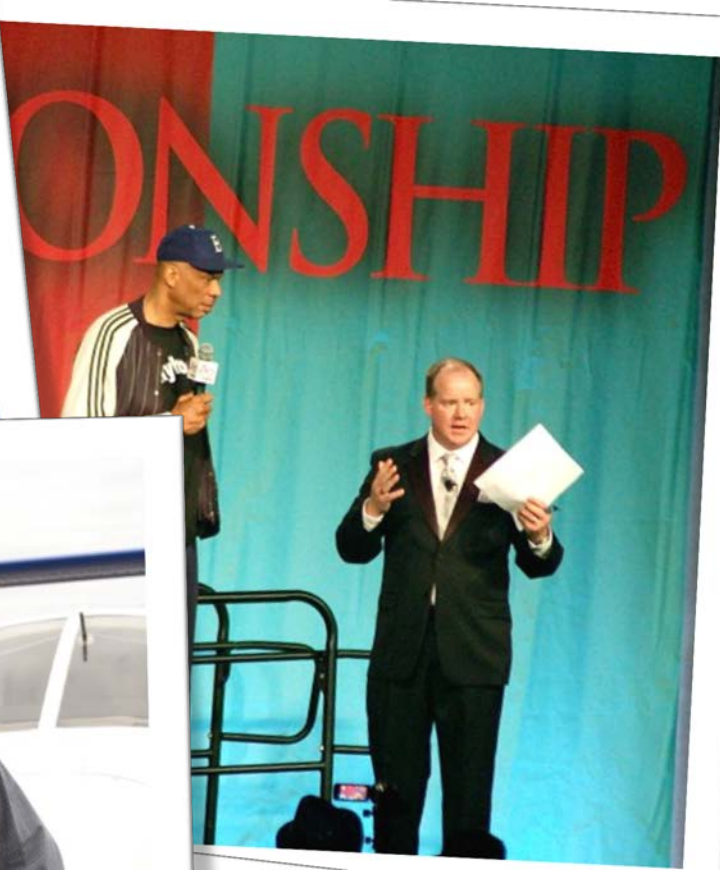

DAVID PRICE

“FIRST makes me smile . . . always. It makes me feel great about the future, because I think every kid I meet is a genius!”



AGENDA

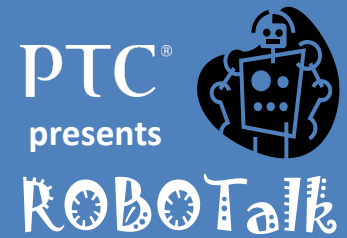

- Poll Everywhere
 - What FIRST program are you competing in? Where are you from?
- The ROBOT Development Process
(a.k.a. the Product Development Process) – Jordan Cox
- Introduction to 3D Modeling – Mark Cheli
 - Poll Everywhere
 - What one word would you use to describe the new FTC game, Cascade Effect?
 - What one word do you think will describe the next FRC game that will be announced in January?
- Design Challenge – David Price
- Questions & Answers

One of the first processes you learned

Steps of the Scientific Method

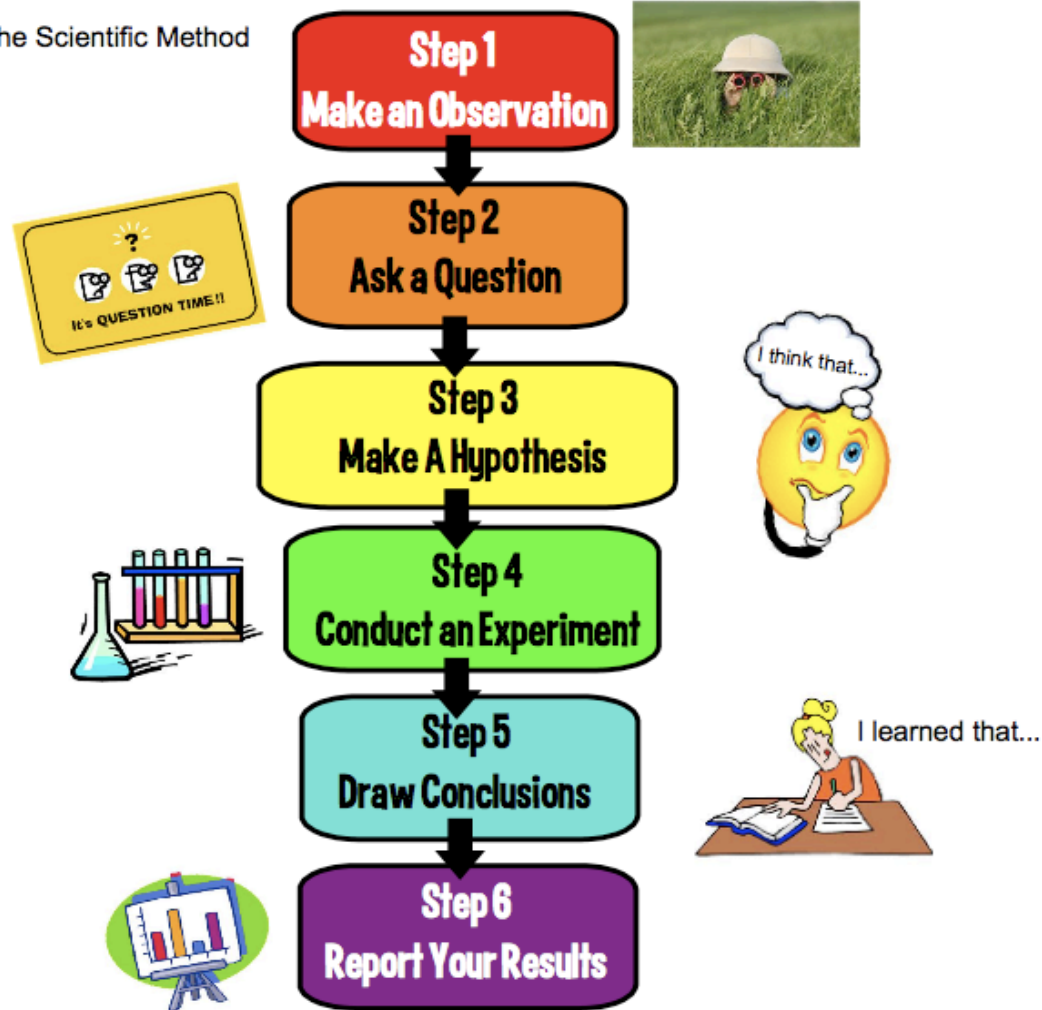

A larger process that encompasses the scientific method (Problem Solving)

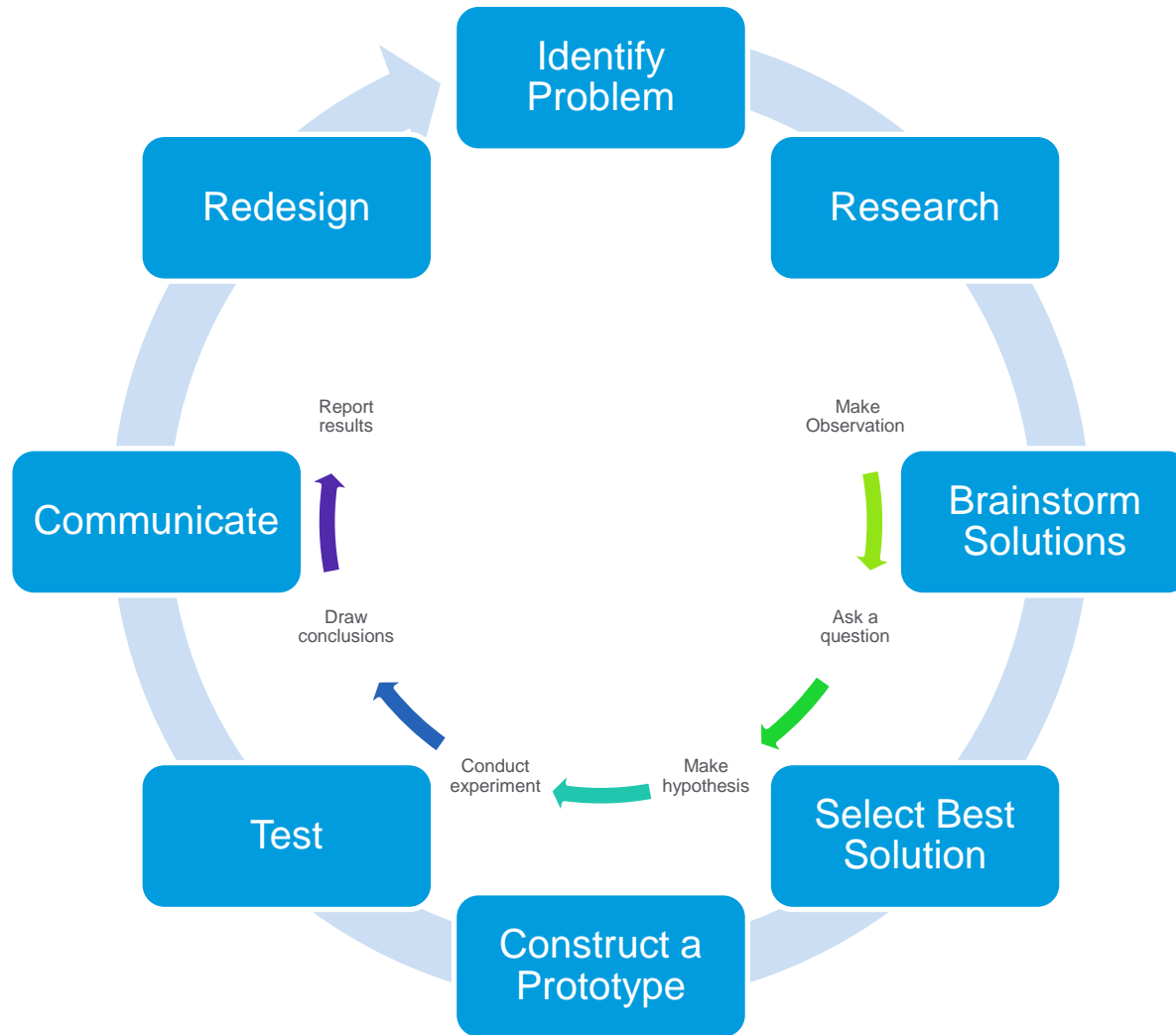

A collection of processes

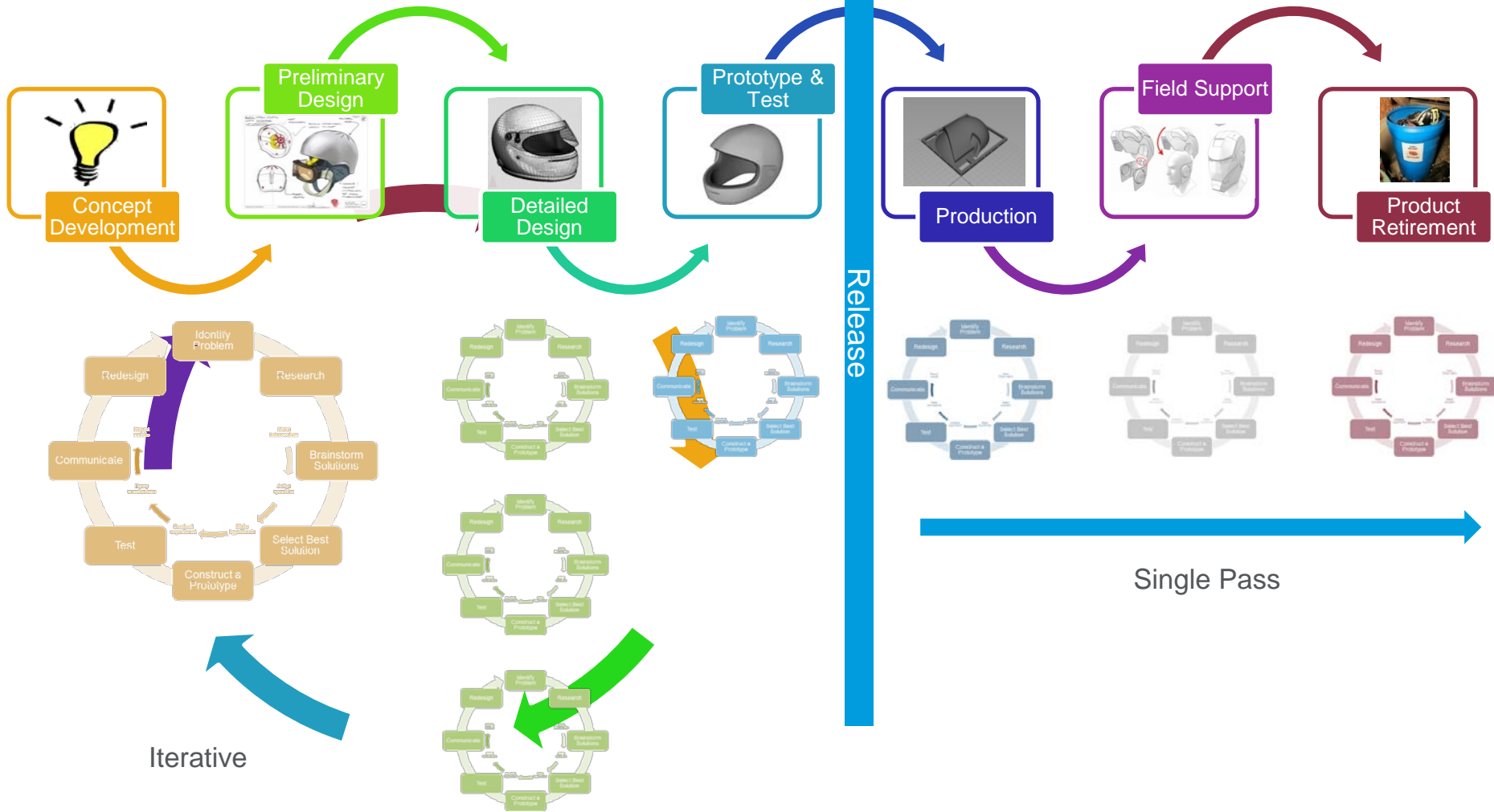

The Product Development Process

The fundamental process for improving quality of life

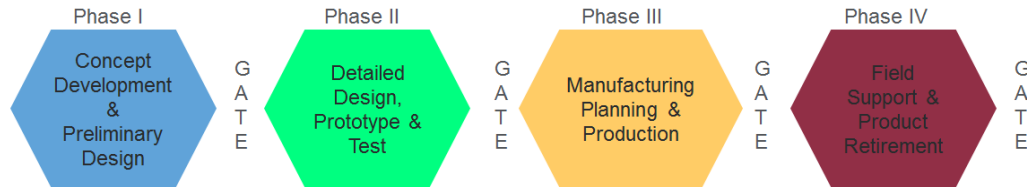
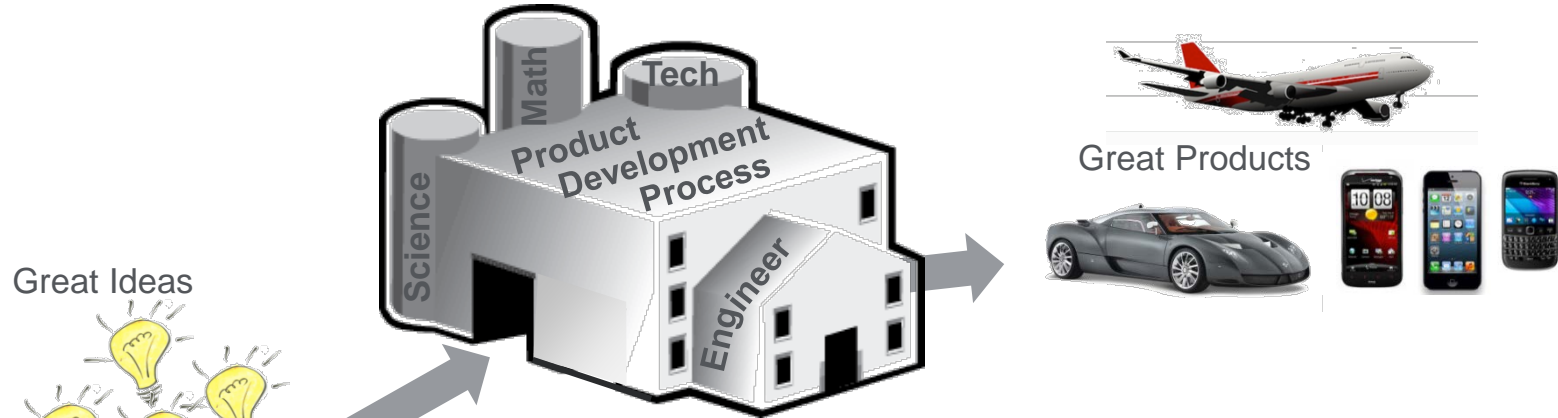

Simplified version

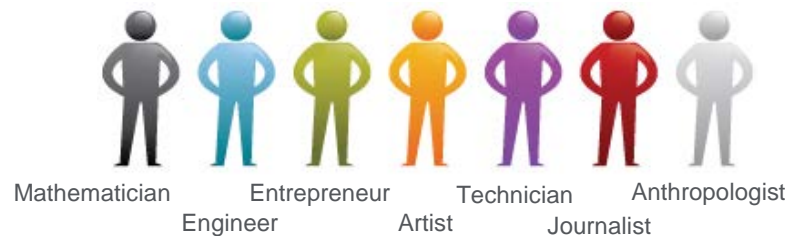

Engages all of society

4 Phases Transforming Ideas into Products

Like 4 consecutive machines

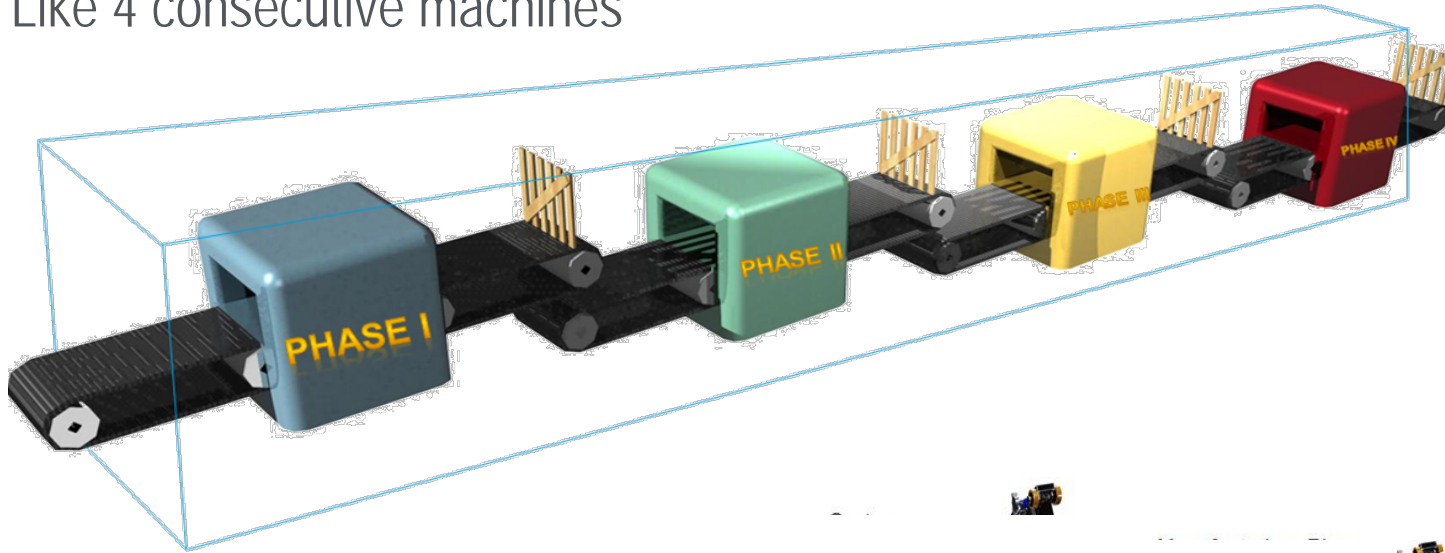

Phase-gate process



Solid Modeling the language of product development

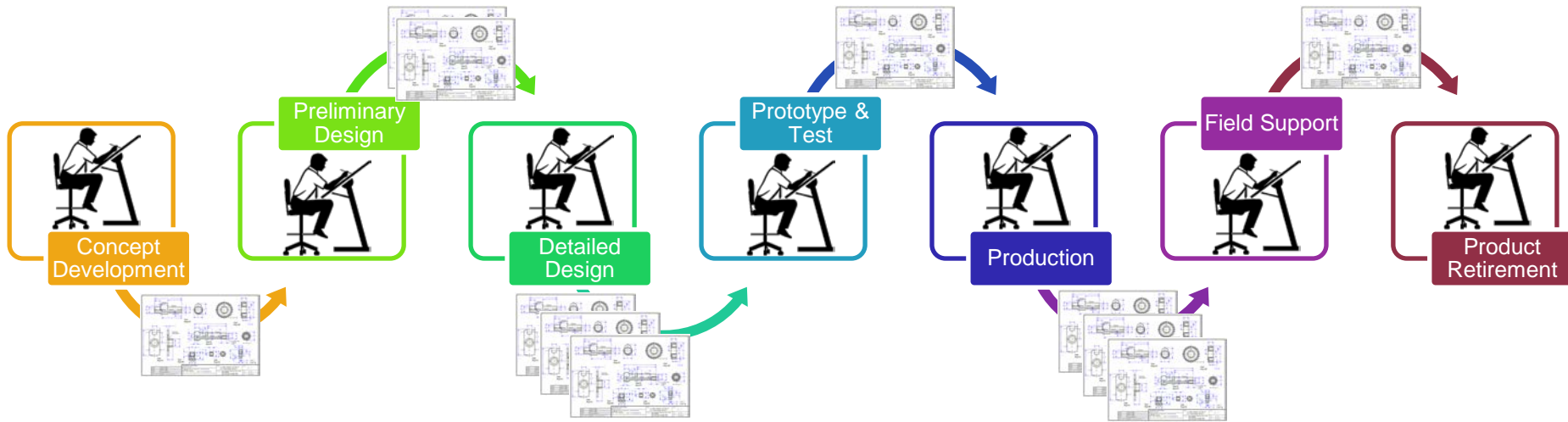

1986 PTC offered the first Solid Modeling Software package

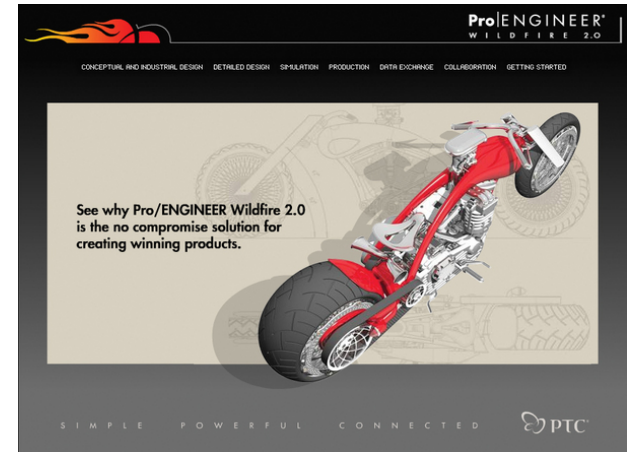
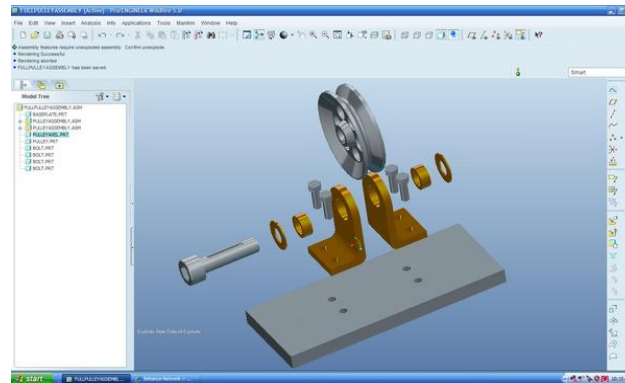
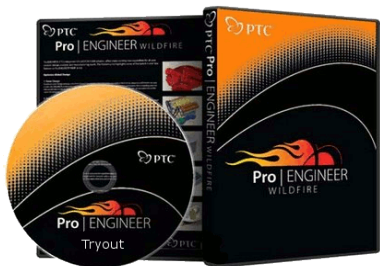

PTC® Windchill® PTC® Integrity™

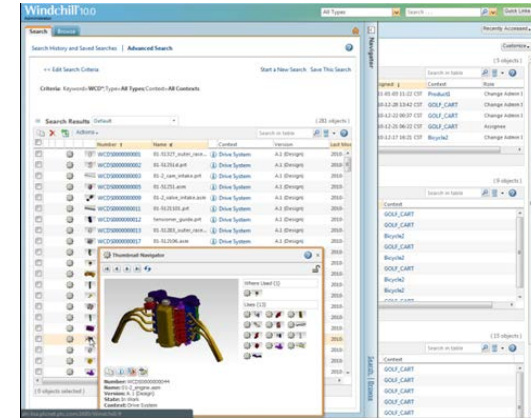
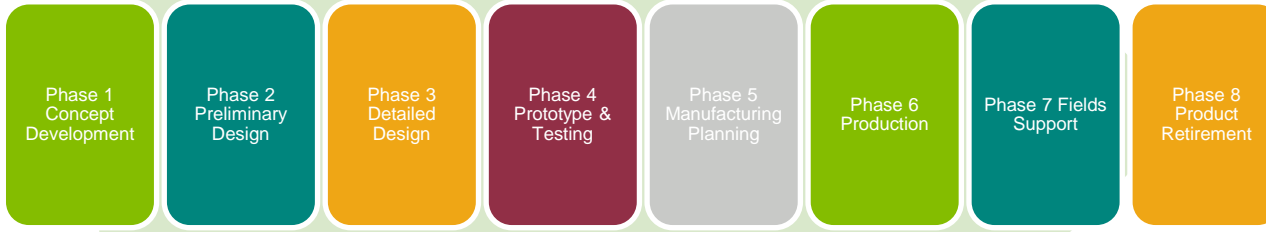

PTC® Creo® (Design)

PTC® Mathcad® (Math)

PTC® Arbortext® (Publications)

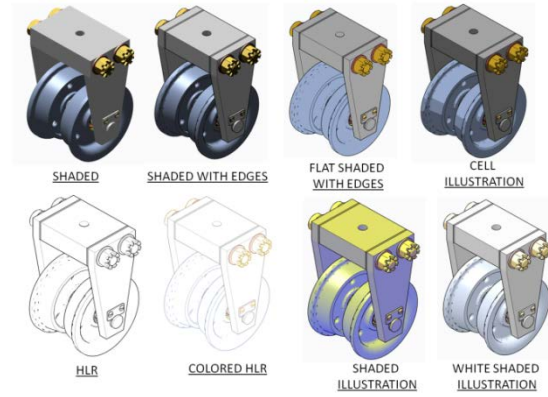
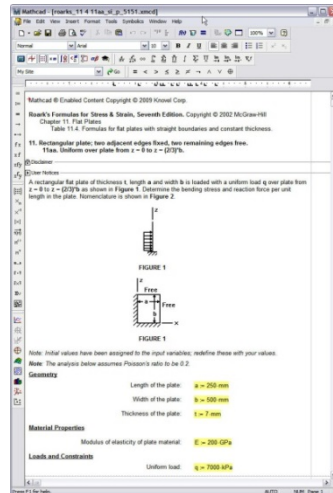
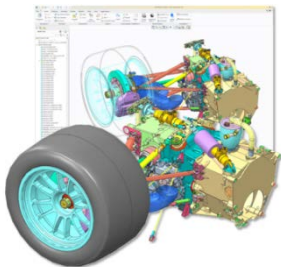
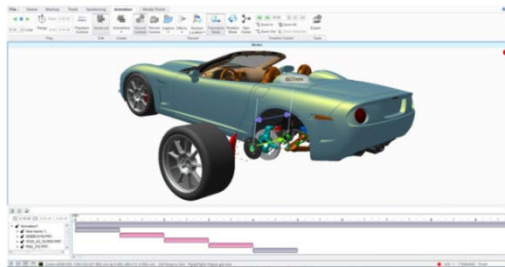

PTC®
presents

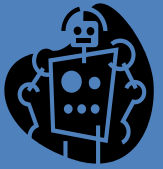

ROBOTalk

INTRODUCTION TO 3D MODELING

With
PTC Creo

DESIGN CHALLENGE – SEP 17TH

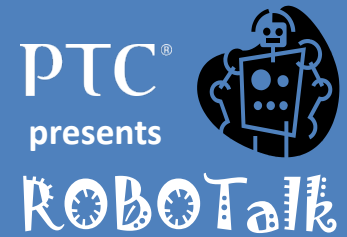

- What do you think is the hardest part of the newest FTC game, “Cascade Effect”, and how are you planning to solve it?



PTC®
presents

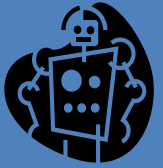

ROBOTalk

**ASK THE EXPERTS...
QUESTIONS?**