

Pro/ENGINEER[®] Wildfire[®] 4.0

**ModelCHECK[™]
Help Topic Collection**

Parametric Technology Corporation

Copyright © 2008 Parametric Technology Corporation. All Rights Reserved.

User and training guides and related documentation from Parametric Technology Corporation and its subsidiary companies (collectively "PTC") is subject to the copyright laws of the United States and other countries and is provided under a license agreement that restricts copying, disclosure, and use of such documentation. PTC hereby grants to the licensed software user the right to make copies in printed form of this documentation if provided on software media, but only for internal/personal use and in accordance with the license agreement under which the applicable software is licensed. Any copy made shall include the PTC copyright notice and any other proprietary notice provided by PTC. Training materials may not be copied without the express written consent of PTC. This documentation may not be disclosed, transferred, modified, or reduced to any form, including electronic media, or transmitted or made publicly available by any means without the prior written consent of PTC and no authorization is granted to make copies for such purposes.

Information described herein is furnished for general information only, is subject to change without notice, and should not be construed as a warranty or commitment by PTC. PTC assumes no responsibility or liability for any errors or inaccuracies that may appear in this document.

The software described in this document is provided under written license agreement, contains valuable trade secrets and proprietary information, and is protected by the copyright laws of the United States and other countries. It may not be copied or distributed in any form or medium, disclosed to third parties, or used in any manner not provided for in the software licenses agreement except with written prior approval from PTC.

UNAUTHORIZED USE OF SOFTWARE OR ITS DOCUMENTATION CAN RESULT IN CIVIL DAMAGES AND CRIMINAL PROSECUTION.

For Important Copyright, Trademark, Patent, and Licensing Information: For Windchill products, select **About Windchill** at the bottom of the product page. For InterComm products, on the Help main page, click the link for Copyright 2007. For other products, select **Help > About** on the main menu for the product.

UNITED STATES GOVERNMENT RESTRICTED RIGHTS LEGEND

This document and the software described herein are Commercial Computer Documentation and Software, pursuant to FAR 12.212(a)-(b) (OCT'95) or DFARS 227.7202-1(a) and 227.7202-3(a) (JUN'95), and are provided to the US Government under a limited commercial license only. For procurements predating the above clauses, use, duplication, or disclosure by the Government is subject to the restrictions set forth in subparagraph (c)(1)(ii) of the Rights in Technical Data and Computer Software Clause at DFARS 252.227-7013 (OCT'88) or Commercial Computer Software-Restricted Rights at FAR 52.227-19(c)(1)-(2) (JUN'87), as applicable. 01012008

Parametric Technology Corporation, 140 Kendrick Street, Needham, MA 02494 USA

Table of Contents

ModelCHECK	1
Using ModelCHECK.....	2
About ModelCHECK	2
About ModelCHECK Teacher.....	2
About ModelCHECK Licenses	2
About the Web Browser for the ModelCHECK Report	3
To Start ModelCHECK	3
To Stop ModelCHECK.....	3
ModelCHECK Operating Modes	3
About the ModelCHECK Operating Modes.....	3
To Run ModelCHECK in Interactive Mode	4
Interactive Mode Checks Using ModelCHECK Regenerate	4
In Part Mode.....	4
In Assembly Mode	4
In Drawing Mode.....	5
To Run ModelCHECK in Regenerate Mode	5
To Run ModelCHECK in Save Mode	5
About Running ModelCHECK in Batch Mode.....	6
To Run ModelCHECK in Batch Mode on UNIX.....	6
Example: Text File for Batch Mode.....	7
To Run ModelCHECK in Batch Mode on Windows.....	7
To Run ModelCHECK from Distributed Pro/BATCH	7
Automatic Corrections in Batch Mode	8
About ModelUPDATE Mode.....	9
To Run ModelCHECK in ModelUPDATE Mode.....	9
Configuring ModelCHECK	9
About Configuring ModelCHECK.....	9
To Configure ModelCHECK	10
Example: ModelCHECK Configuration Files Flow Chart	11

Table of Contents

Controlling Access to the Configuration Files	12
About Integrating ModelCHECK with a PDM System	12
Using ModelCHECK with Windchill.....	13
Setting Up the Initialization File: config_init.mc File	14
About the config_init.mc File.....	14
To Set Up the config_init.mc File Using the PTC ModelCHECK Configuration Tool	14
To Manually Set Up the config_init.mc File	14
Configuration Options in the config_init.mc File	15
Example: config_init.mc File	19
Duplicate Models in ModelCHECK	21
About Duplicate Models	21
About Storing Shape Information.....	22
To Create the mc_dup_model.bin File.....	22
About Using the Windchill Database	23
About Using the Pro/INTRALINK Commonspace	24
About Using the Pro/INTRALINK Commonspace for Legacy Models	25
To Set Up the mcilupdLCA Application	25
To Set Up the mcilsearch Application.....	26
To Set Up the mcilchkout Application.....	27
Setting Up the Condition Files	29
Setting Up the Condition File: setconf.mcc	29
About the setconf.mcc File	29
To Set Up the setconf.mcc File Using the PTC ModelCHECK Configuration Tool	29
To Manually Set Up the setconf.mcc File	30
Customizing Load Config Menu in msg_mc.txt	30
Setting Up the Condition File: condition.mcc	32
About the condition.mcc File	32
To Set Up the condition.mcc File Using the PTC ModelCHECK Configuration Tool	32
To Manually Set Up the condition.mcc File.....	33

Example: condition.mcc File33

About the SET CONFIG FILE Section of the condition.mcc File34

Items You Can Use in Equality Statements35

About Groups36

To Set Up the Group Files Using the
PTC ModelCHECK Configuration Tool36

To Manually Set Up the Group Files37

Configuring for Pro/ENGINEER Releases37

Configuring for Model Creation Dates37

Combining Several Start Files37

Example: SET CONFIG FILE Sample Lines Explained38

About the OVERRIDE CHECKS Section of the condition.mcc File39

Example: OVERRIDE CHECKS Sample Lines Explained39

Setting Up the Check Configuration File40

 About the Check Configuration File40

 To Set Up the Check Configuration File Using the
 PTC ModelCHECK Configuration Tool41

 To Manually Set Up the Check Configuration File41

Part Mode Checks42

Assembly Mode Checks49

Drawing Mode Checks50

GeomIntegrityCHECK Checks52

ModelUPDATE Checks55

Storing Metrics for Checks56

Setting Up the Start Configuration File57

 About the Start Configuration File57

 To Set Up the Start Configuration File Using the
 PTC ModelCHECK Configuration Tool57

 To Manually Set Up the Start Configuration File58

Start File Configuration Options Summary58

Part and Assembly Mode Configuration Options for the Start File61

Drawing Mode Configuration Options for the Start File62

Table of Contents

Setting Up External Files	63
About External Files	63
To Set Up the External Files Using the PTC ModelCHECK Configuration Tool	63
To Manually Set Up the External Files	63
External Files Configuration Options for the Start File	63
Custom Configurable Checks	64
Setting Up the Constant Configuration File.....	66
About the Constant Configuration File	66
To Set Up the Constant Configuration File Using the PTC ModelCHECK Configuration Tool	66
To Manually Set Up the Constant Configuration File.....	67
Example: Constant Configuration File (.mcn)	67
Options in the Constant Configuration File	68
Setting Up the Status Configuration File	69
About the Status Configuration File.....	69
To Set Up the Status Configuration File Using the PTC ModelCHECK Configuration Tool	69
To Manually Set Up the Status Configuration File	70
Example: Status Configuration File (.mcq)	70
Using the Spell Checker	70
About the Spell Checker	70
To Use the Spell Checker	70
Spell Checker Dictionaries	70
ModelCHECK Reports.....	71
About ModelCHECK Reports	71
To Configure Report Titles	71
To Use the ModelCHECK Report.....	72
Example: Modifying the msg_mcmmsg.txt File	73
Summary Reports	74
ModelUPDATE Report.....	74
Optimizing ModelCHECK	75

- About Optimizing ModelCHECK for Speed75
- RuleCHECK76
 - About RuleCHECK.....76
 - To Start RuleCHECK76
 - Types of Rules76
 - Defining Rules77
 - Soft Rules77
 - Hard Rules77
 - Implementing RuleCHECK78
 - Integrating RuleCHECK with ModelCHECK.....78
 - Example: Using RuleCHECK79
- Using GeomIntegrityCHECK.....80
 - About GeomIntegrityCHECK80
 - To Set Up GeomIntegrityCHECK80
 - To Start GeomIntegrityCHECK81
 - Setting Check Criteria82
 - GeomIntegrityCHECK Configuration Options and Their Settings82
 - All Geom Type Checks84
 - Curve and Drawing Checks.....98
 - Surface Checks99
 - Face Checks102
 - Topology Checks105
 - Solids Checks106
- Metrics Tool109
 - About the Web-Enabled ModelCHECK Metrics Tool109
 - About the Task Sets and Functions110
 - About the Setup of the ModelCHECK Metrics Tool110
 - Displaying Graphs and Reports.....110
 - Setting Parameters in the Context Files111
 - About the Database for the Metrics Tool111
 - To Update the Database Tables Using create_mcadadmin_db.jar112

Table of Contents

About the Metrics Database	114
About the Training Database.....	114
About the User Database	115
Troubleshooting Tips for the Display of Graphs and Tables.....	115
Overview	116
About the Overview Page	116
Performing Administration Functions.....	117
About the Administration Functions that You Can Perform.....	117
To Define a Critical Check Set	118
To Specify a Check Set for a Group.....	118
To View ModelCHECK Data	118
To View the Training Database	119
To View the Experience Level of a User	119
To Set the Quality Goals of the Company.....	120
Generating Analysis-Graphs.....	120
About Generating and Displaying Analysis Graphs.....	120
To Create a Graph on Errors or Warnings.....	121
Example: A Graph on Errors and Warnings	122
To Display a Graph of the Most and Least Frequently Passed Checks	122
Example: A Graph on the Least Frequently Passed Checks	123
To Display a Graph for the Number of ModelCHECK Runs.....	123
To Display a Graph on User Experience	124
Example: A Graph on User Experience	124
To Create a Graph on Training Costs of Users or a Course.....	124
Example: A Graph on Training Investment.....	125
Setting Preferences	125
About Setting Preferences	125
To Set Data Filters for the Metrics Analysis	126
To Set Preferences for the Display of Graphs and Tables.....	127
To Set Preferences for the Creation of Reports	128
Searching for Failed Checks.....	129

To Search for Failed Checks 129

 Example: A Report on Failed Checks 129

Model Accuracy in ModelUPDATE 130

ACCURACY_INFO (Accuracy Information) 130

ACCURACY_LOW 130

ACCURACY_UPP 130

ADD_CHK_PARAM (Add a Parameter) 131

ADD_CONFIG_PARAM 131

ADD_DATE_PARAM 131

ADD_DUP_INFO_AUTO 131

ADD_ERR_PARAM 132

ModelCHECK Teacher 132

 Additional Information 132

ADD_MODE_PARAM 133

ADD_MU_STAMP 133

AE_GTOL_DUPLICATE (Duplicate Geometric Tolerance Annotation Elements) 133

AE_MISSINGREFS (Annotation Elements with Missing References) 134

AE_SF_DUPLICATE (Duplicate Surface Finish Annotation Elements) 134

AF_INCOMPLETE (Incomplete Annotation Features) 135

ANNTN_INACTIVE (Inactive Annotations) 135

ASM_BATCH_ALL 135

ASM_BOM (Assembly Bill of Materials) 136

ASM_FEATURES (Assembly Features) 136

ASYNC_PORT 136

BOUND_INFO (Boundary Information) 136

BULK_ITEMS (Bulk Items) 137

BURIED_ADVANCED 137

BURIED_FEAT (Buried Features) 137

ModelCHECK Teacher: Buried Features 138

 What causes buried features? 138

 Example 1: Cut eliminates the handle on the coffee cup. 138

Table of Contents

Example 2: Element of patterned protrusion is hidden from view.	141
Why are buried features dangerous?.....	142
How can buried features be avoided?.....	142
C7_SELF_DIST (Distance from Itself)	142
CHAMFER_CHILD (Children of Chamfers)	142
CHECK_ALL_MODELS	143
ModelCHECK Teacher: Features that are Children of Rounds, Drafts, or Chamfers	143
What causes features that are children of rounds, drafts or chamfers?	143
Why are features that are children of rounds, drafts or chamfers dangerous?	143
How can features that are children of rounds, drafts or chamfers be avoided?	145
CHILDREN_EXIST (Standard Children).....	145
CIRCULAR_REFS (Circular References).....	145
CNFG_SELECT_AUTO	146
COSMETIC_FEAT (Cosmetic Features)	146
CREATE_VIEW (Create Views)	146
Create Views for ModelUPDATE	146
Custom Checks File	147
CYL_CUT_SLOTS (Cuts and Slots That Should Be Holes)	147
CYL_DIAMS (Circular Cut Diameters).....	147
D28_IGES_TEXT (IGES Conform Text).....	148
DATUM_RENAME (Renaming Datums)	148
ModelCHECK Teacher: Datum Features	148
DEF_DENSITY (Model Density)	149
DEFAULT_CHILD (Children of the Default Datum Planes).....	149
DEFAULT_VIEWS (Views with the Default Hidden Line Display Mode)	149
DEPENDENT_FEATURE (Dependent Features)	150
DESIGNATE_MU_STAMP	150
DESIGNATED_ATTR (Designated Attributes)	150
DIM_OVERWRITE (Overwritten Dimensions)	150

ModelCHECK Teacher: Dimensions 151

DIR_MC_BACKUP_CONFIG 151

DIR_MC_BACKUP_CONFIG_NT 151

DIR_MC_BACKUP_CONFIG_U 151

DIR_MC_DUP_READ 152

DIR_MC_DUP_READ_NT 152

DIR_MC_DUP_READ_U 152

DIR_MC_DUP_WRITE 152

DIR_MC_DUP_WRITE_NT 152

DIR_MC_DUP_WRITE_U 153

DIR_MC_PREVIEW 153

DIR_MC_PREVIEW_NT 153

DIR_MC_PREVIEW_U 153

DIR_METRICS 153

DIR_METRICS_NT 154

DIR_METRICS_U 154

DIR_REPORT 154

DIR_REPORT_NT 154

DIR_REPORT_U 154

Draft Angle File 155

DRAFT_ANGLES (Standard Draft Angles) 155

DRAFT_CHILD (Children of Draft) 155

DRAFT_GEOM (Draft Geometry not Associated to a View) 156

ModelCHECK Teacher: Draft Entities that are not Attached to a View 156

Drawing Detail File 156

Drawing Format 157

Drawing Information 157

DRAWING_LAYERS (Drawing Layers) 158

DRAWING_NAME (Drawing Name) 158

Drawing Note Fonts and Heights 158

DRAWING_PARAMS (Parameter Checks) 158

Table of Contents

Drawing Sheets to be Ignored	159
Drawing Symbols.....	159
Drawing Table Cells.....	159
Format.....	160
DRW_SHEET_ALL.....	160
ModelCHECK Teacher: Drawing Formats	160
DTM_AXES_INFO (Datum Axis Information)	160
DTM_CSYS_INFO (Coordinate System Information)	161
DTM_CURVE_INFO (Datum Curve Information).....	161
DTM_PLANE_INFO (Datum Plane Information)	161
DTM_POINT_INFO (Datum Point Information).....	161
DUPLICATE_MODELS (Duplicate Models)	162
ModelCHECK Teacher: Early Drafts and Rounds	162
Why are early drafts and rounds dangerous?	162
EARLY_CHAMFER (Early Chamfers)	164
EARLY_COSMETIC (Early Cosmetic Features).....	164
EARLY_DRAFT (Early Draft).....	164
EARLY_ROUND (Early Rounds).....	165
EDGE_REFERENCES (Features That Reference Edges).....	165
ERASED_VIEWS (Erased Views).....	165
ModelCHECK Teacher: External References	166
What causes external references?	166
Why are external references dangerous?	167
How can external references be avoided?	167
External Lists	168
EXTERNAL_DEPS (External Dependencies)	169
EXTRA_LAYERS (Extra Layers).....	169
EXTRA_PARAMS (Extra Parameters)	169
F14_BOUND_DIST (Penetration or Distance of Boundaries)	170
F15_SURF_DIST (Proximity of a Boundary Curve to its Surface).....	170
F16_SIM_ORIENT (Parallel Path or Similar Orientation).....	170

F17_NUM_SEG (Number of Segments in a Boundary Curve)	171
FAMILY_INFO (Family Table Information)	171
Family Table Parameter	171
FEATURE_INFO (Feature Information)	172
FILE_SIZE (File Size).....	172
FORMAT_NAME (Drawing Format Name)	172
FREEFORM (Freeform Surfaces)	172
FRZ_COMPONENTS (Frozen Components)	173
FT_DEF_VALS (Family Table Default Values).....	173
FT_STD_PARMS (Family Table Standard Parameters)	173
ModelCHECK Teacher: Surface Gaps and Overlaps	174
Why are surface gaps and overlaps dangerous?	174
How can surface gaps and overlaps be avoided?.....	174
GEN_COMPONENTS (Generic Components)	174
GEOM_CHECKS (Geometry Checks)	174
ModelCHECK Teacher: Geometry Checks.....	175
What causes geometry checks?.....	175
Example:	176
How can geometry checks be avoided?	176
GEOMETRIC_TOL (Geometric Tolerances)	176
GeomIntegrityCHECK Constants.....	177
GLOBAL_INTF (Assembly Global Interference)	177
HIGHLIGHT_COLOR	178
Hole and Cut Diameter File.....	178
HOLE_DIAMS (Standard Hole Diameters)	178
HTML_FILE_OUTPUT.....	179
HTML_FILE_OUTPUT_REPXSL	179
HTML_MAX_DAYS	179
IGNORE_FEAT (Problem Features That Should Be Ignored)	179
IGNORE_SHEETS (Sheets to Be Ignored)	180
ILNK_MC_DUP_FLDR	180

Table of Contents

ILNK_MC_PRVW_SCRPT.....	180
ILNK_MC_SRCH_SCRPT	181
IMPORT_FEAT (Imported Features)	181
INCOMPLETE_FEAT (Incomplete Features)	181
INSERT_MODE (Insert Mode Left Active).....	181
INSTANCE_NAME (Instance Name)	182
INTRALINK_DUPINFO	182
ModelCHECK Teacher: Layer Checks.....	182
LAYER_DISPSTAT (Layers That Are Set to Isolate)	183
LAYER_DTM_BLANK (Datum Features on Blanked Layers)	184
LAYER_EXT_ITEMS (Extra Features on Layers)	184
LAYER_INFO (Layer Information)	184
LAYER_ITEMS (Items on Multiple Layers)	185
LAYER_MOVE (Move Items from Old Layers to New Ones and Delete the Old One)	185
Layer Move	185
LAYER_PLACE (Layers Contain Standard Items)	186
LAYER_STATUS (Layer Status)	187
LAYER_UNWANTED (Unwanted Layers).....	187
Layers.....	187
Extra Layers.....	189
Sub-Layers.....	189
LAYOUT_INFO (Layout Information)	189
Length Units	190
LOW_TOLERANCE (Lowest Allowable Tolerance).....	190
M1_TINY_ELMNT (Tiny Elements)	190
M2_IDENTICAL_ELMNT (Identical Elements).....	191
M3B_TANG_CONT (Tangential Continuity).....	191
M3A_POSITION_CONT (Position Continuity)	191
M3C_CURV_CONT (Curvature Continuity).....	192
M4_POLYN_DEG (Polynomial Degree)	192

M5_WAVINESS (Waviness)	192
M6_KNOT_DIST (Knot Distance)	193
Mass Units	193
MATERIAL_INFO (Material Type)	193
Material Name	194
MAX_ABS_ACCURACY	194
MAX_DRAW_SHEETS	194
MAX_SKETCH_ITEMS	194
MC_AUTHORIZATION_FILE	194
MC_ENABLE	194
MC_METRICS	195
MC_VDA_RUN	195
MCREGEN_VERIFY_FT_INSTS	195
MCSI1_TOL	195
MCSI2_TOL	195
MCSI3_TOL	195
MCSI4_TOL	195
MCSI5_TOL	196
MEMORY_SPACE (Memory Space Used)	196
ModelCHECK Teacher: Merged and Cutout Features	196
Why are merged and cutout features dangerous?	196
MERGE_FEAT (Merged Features)	196
MIN_ABS_ACCURACY	197
MIN_TOLERANCE	197
MINMAXTOL_INFO (Minimum and Maximum Tolerances)	197
MIS_COMPONENTS (Missing Components)	197
MODE_RUN	197
MODE_UPDATE	198
MODEL_NAME (Model Name Specification Errors)	198
Model Name	198
MODEL_NAME_STR (Model Name)	200

Table of Contents

Model Parameters	200
MODELS_USED (Models Used in a Drawing)	201
MU_ENABLED	201
MU_REGENERATE	201
NAMED_FEAT (Named Features)	201
Unwanted Layers for ModelUPDATE	201
Unwanted Parameters for ModelUPDATE	202
NOTE_CASE (Note Case).....	202
NOTE_FONT (Note Fonts).....	202
NOTE_HEIGHT (Note Height).....	202
NOTE_INFO (Drawing Note Information)	203
NOTE_SPELL (Note Spelling Errors)	203
NOTE_UNACCEPT (Unacceptable Notes).....	203
NUM_COMPONENTS (Number of Components).....	204
NUM_DRAW_SHEETS (Maximum Number of Drawing Sheets)	204
NUM_ITEMS_LONG_LIST	204
OVERALL_SIZE (Overall Size)	204
OVERLAP_INFO (Overlap Information)	205
ModelCHECK Teacher: Parameter Information	205
Types of Parameters used by ModelCHECK	205
PACK_COMPONENTS (Packaged Components)	206
PARAM_INFO (Model Parameters)	206
PARAM_MAP (Parameter Mapping)	207
PARAM_NOTE_REQ (Required Parameter Notes)	207
PARAM_NOTE_UNACC (Unacceptable Parameter Notes)	207
PARAM_RENAME (Parameter Rename).....	208
PARAM_SPELL (Parameter Spelling)	208
PARAM_UNUSED (Unused Parameters)	208
PARAM_UNWANTED (Unwanted Parameters)	208
PARAMCHECK (Parameter Format Errors).....	209
Parameter Mapping for ModelUPDATE	209

Parameter Rename	209
Parameters	210
PARAMS_EXIST (Drawing Parameters).....	212
PARAMS_USED (Drawing Parameters Used)	212
PARENT_HI_COLOR.....	213
PERC_EARLY_CHAMF.....	213
PERC_EARLY_COSMETIC.....	213
PERC_EARLY_DRAFT	213
PERC_EARLY_ROUND	213
PLANE_CHILD (Datum Planes without Children)	213
PLANE_PARENT (Datum Planes That Only Have One Parent)	214
Pro/ENGINEER Build and Version	214
PRO_VERSION (Version of Pro/ENGINEER)	214
PROGRAM	215
RC_INCOMPLETED (RuleCHECK Rules That Are Not Complete)	215
RC_PARAMETER_NAME.....	215
REG_FEATURES (Resumed Features).....	215
REGEN_DIMS (Dimensions That Cannot Regenerate)	215
REGEN_ERRS (Regeneration Errors).....	216
REGEN_WRNS (Regeneration Warnings)	216
ModelCHECK Teacher: Dimensions that Will Not Regenerate	216
Regeneration Messages	217
ModelCHECK Teacher: Regeneration Errors	217
What causes regeneration errors?	217
REL_UNWANTED (Unwanted Relations).....	219
Relation and Relation Comments.....	219
RELATION_COMM (Comments in Relations).....	219
RELATION_ERRS (Relation Errors).....	219
RELATION_INFO (Relation Information)	219
RELATION_MISS (Relations That Are Missing).....	220
RELATION_MULT (Relations That Have Multiple Assignments)	220

Table of Contents

RELATION_UPDATE (Relations That Need Update)	220
Relation Update File	221
RENAMED_SYMBOLS (Renamed Dimension Symbols)	221
REPT_LAYR_ALWAYS (Report Missing Layers)	221
Required and Unacceptable Parameter Notes	222
ROUND_CHILD (Children of Rounds)	222
RULECHECK_INFO (RuleCHECK Information)	223
SAVE_MC_PRE	223
SAVE_MU	223
SEARCH_DUP_MODELS (Search for Duplicate Models)	223
SHTMTL_THICK (Standard Sheet Metal Wall Thicknesses)	224
SHTMTL_UNBENDS (Sheet Metal Unbends)	224
SHTMTL_YFACTOR (Sheet Metal Y-Factor).....	224
ModelCHECK Teacher: Simplified Representations	225
SIMPREP_INFO (Simplified Representations)	225
SIMPREP_NAME (Simplified Representation Names)	225
SKETCH_ITEMS (Number of Entities in a Sketched Feature).....	225
SKIP_MODELS.....	226
ModelCHECK Teacher: SLA (STL) Information	226
SLA_INFO (SLA Information).....	226
ModelCHECK Teacher: Small Cylindrical Surfaces and Edges	227
Why are small cylindrical surfaces and edges dangerous?	227
SMALL_CYLSRF (Small Cylindrical Surfaces)	227
SMALL_RADIUS	227
SO21_DIST_VERT_EDGE (Distance to Vertex Edge)	227
SO22_DIST_VERT_FACE (Distance to Vertex Face).....	228
SO23_HIST_DELETE (Deletion of History)	228
SO24_EXTRA_GEOM (Auxiliary Geometry)	228
SO25_CAVITIES (Cavities)	229
SO26_MULT_BODY (Multi-Body Solids)	229
SO27_MULT_SOLID (Multi-Solid Parts)	229

SRF_EDGES (Surface Gaps and Overlaps)	229
Standard Datums.....	230
Standard Model Notes	230
ModelCHECK Teacher: Start Part and Start Assembly Items.....	231
STARTCHECK (Start Part and Start Assembly Check)	232
Missing Layers.....	232
Missing Parameters	233
STD_DTL_SETUP (Drawing Detail File).....	233
STD_NOTES_MISSING (Missing Standard Notes).....	233
SU10_BOUND_ANGLE (Angle Between Edge Curves)	234
SU11_NORM_REVERSAL (Reversal of Normals).....	234
SU12_PATCH_DIST (Patch Distribution)	234
SU13_UNOC_PATCH_ROW (Unoccupied Patch Rows)	234
SU8_TINY_SEG_EDGE (Tiny Segment Edge)	235
SU9_TINY_CURV_RAD (Minimum Curvature Radius).....	235
SUP_COMPONENTS (Suppressed Components)	235
SUP_FEATURES (Suppressed Features).....	236
SYMBOL_INFO (Symbol Information).....	236
SYMBOL_SPELL (Spelling Mistakes in Symbols).....	236
T18_NUM_FACE (Junction or Number of Faces Per Edge)	236
T19_NORMAL_ORIENT (Orientation of Similar Normals)	237
T20_KNIFE_EDGES (Knife Edge)	237
TABLE_CELLS (Table Cells)	237
TITLE_INFO (Title Block Information)	238
TITLE_SPELL (Title Block Spelling Errors)	238
ModelCHECK Teacher: Sharp Edges.....	238
Why are sharp edges dangerous?	239
SHARP_ANGLE	239
SHARP_EDGES (Sharp Edges)	239
Sheet Metal Bend Table	240
Sheet Metal Thickness File	240

Table of Contents

SHEET_SIZE_INFO (Sheet Size Information)	240
SHORT_EDGE and SHORT_EDGE_BATCH	240
SHORT_EDGES (Short Edges).....	241
SHOW_REPORT	241
SHTMTL_BENDTAB (Sheet Metal Bend Tables)	241
SHTMTL_FLAT (Sheet Metal Flat Patterns or Flat States)	242
ModelCHECK Teacher: Dimensional Tolerances	242
Tolerance Type	242
UDF_INFO (UDF Information)	242
Unacceptable Notes in Drawings	243
ModelCHECK Teacher: Sheet Metal Parts with Consecutive Unbend and Bend Back Features	243
How can sheet metal parts with consecutive unbend and bend back features be avoided?	243
UNITS_LENGTH (Length Units)	243
UNITS_MASS (Mass Units)	244
UNQ_COMPONENTS (Unique Components)	244
ModelCHECK Teacher: Unused Models	244
UNUSED_MODELS (Unused Models in Drawings)	245
UNUSED_SHEETS (Empty Sheets).....	245
Unwanted Relations for ModelUPDATE	245
UPDATE_INTER_ASM.....	246
UPDATE_SHEETMETAL.....	246
UPDATE_SKELETON	246
VIEW_INFO (View Information)	246
VIEW_SCALE (Scale Assigned to Views)	246
Views	246
WC_DUPINFO	247
XSEC_INFO (Cross Section Information)	247
Index	249

ModelCHECK

ModelCHECK Overview

The ModelCHECK Help describes how you can use ModelCHECK as a comprehensive and collaborative model analysis tool. Refer to these topics for information on configuring ModelCHECK, on using the tools and checks available in ModelCHECK, and on using the ModelCHECK reports.

Tasks for ModelCHECK

Getting Started with ModelCHECK

Using ModelCHECK
Using the ModelCHECK Operating Modes
Using ModelUPDATE

Configuring ModelCHECK

Using the ModelCHECK Configuration Files
Setting Up the Initialization File: config_init.mc File
Setting Up the Condition File: setconf.mcc File
Setting Up the Condition File: condition.mcc File
Setting Up the Check Configuration File
Setting Up the Start Configuration File
Setting Up the Constant Configuration File
Setting Up the Status Configuration File

Using the ModelCHECK Reports

Creating the ModelCHECK Report
Creating Summary Reports

Using ModelCHECK with Data Management Systems

Integrating ModelCHECK with a PDM System
Using ModelCHECK with Windchill
Using ModelCHECK with Pro/INTRALINK

Using the Tools Available in ModelCHECK

Searching for Duplicate Models
Using the Spell Checker
Optimizing ModelCHECK
Using RuleCHECK
Using GeomIntegrityCHECK
Using the Metrics Tool

Using ModelCHECK

About ModelCHECK

ModelCHECK is an integrated application that runs transparently within Pro/ENGINEER. ModelCHECK uses a configurable list of company design standards and best modeling practices. It can be configured to run interactively as well as automatically when you regenerate or save a model.

ModelCHECK:

- Analyzes parts, drawings, and assemblies.
- Verifies compliance with standards and proper Pro/ENGINEER modeling techniques and immediately flags modeling violations.
- Presents the results of the analysis and recommends improvements in the form of a dynamic HTML report. The ModelCHECK report appears in the browser embedded in Pro/ENGINEER.
- Promotes the use of standard design practices to improve the effectiveness of downstream users and design reuse.

About ModelCHECK Teacher

You may not always know what causes the problems or errors identified by ModelCHECK. ModelCHECK Teacher is a series of Web pages containing information about common modeling errors and how to fix them. It may help you avoid errors in the future.

To access the online help for a check, click the icon to the left of each item in a report. This loads a page with information specific to the check. These pages have links to the Pro/ENGINEER Help for additional information. For checks that need detailed explanation, another link on the same page takes you to a ModelCHECK Teacher page that explains the check in greater depth and references additional help.

ModelCHECK's Teacher pages have references to the Pro/ENGINEER Help for additional information.

About ModelCHECK Licenses

ModelCHECK has two types of licenses:

- ModelCHECK Extension
 - This license is linked to a Pro/ENGINEER license. As the license is a part of Pro/ENGINEER, it does not need to be checked out. This license is included in the following packages:
 - Foundation Advantage Package
 - Flex3C Package

- Pro/ENGINEER Foundation II
- Pro/ENGINEER Foundation Value Pack
- Pro/ENGINEER Foundation Value Pack II
- Flexible Engineering
- Flexible Engineering II
- ModelCHECK Option

This license is independent of the Pro/ENGINEER license. The license is checked out when ModelCHECK is run for the first time during a Pro/ENGINEER session. If a license is not available, a message appears.

Note: This license can no longer be separately purchased from PTC. This is a legacy license.

About the Web Browser for the ModelCHECK Report

The ModelCHECK report appears in the browser embedded in Pro/ENGINEER. Outside Pro/ENGINEER, you can view the report on a DOM2 (Document Object Model Level 2) compliant browser (Mozilla 1.4.1 and Internet Explorer 6.0 SP1 or higher).

To Start ModelCHECK

1. Ensure that the `modelcheck_enabled` configuration option in the Pro/ENGINEER `config.pro` configuration file is set to `yes`. This is the default.
2. Start Pro/ENGINEER.
3. Click **Analysis > ModelCHECK > ModelCHECK Interactive**.

Note: You can limit or disable ModelCHECK with the `MC_ENABLE` configuration option located in the `config_init.mc` file.

To Stop ModelCHECK

In Interactive mode of ModelCHECK, you can stop it by clicking the red stop button in the lower-right corner of the Pro/ENGINEER window.

In Batch mode, use the Task Manager or kill the ModelCHECK process to stop ModelCHECK.

ModelCHECK Operating Modes

About the ModelCHECK Operating Modes

You can run ModelCHECK in four ways, depending on how it is configured.

- **Interactive Mode** - Runs ModelCHECK when you click **Analysis > ModelCHECK** in Pro/ENGINEER.

- **Regenerate Mode** - Runs ModelCHECK after every regeneration. Running ModelCHECK in Regenerate mode is the most effective use of ModelCHECK. In this mode, ModelCHECK automatically runs every time you regenerate the model. Problems are found immediately after they occur when they are easier to correct.
- **Save Mode** - Runs ModelCHECK after every save operation.
- **Batch Mode** - Runs ModelCHECK outside of Pro/ENGINEER. Use Batch mode to run ModelCHECK on a number of parts, assemblies, or drawings.

You can customize each mode to run a different set of checks.

To Run ModelCHECK in Interactive Mode

1. Click **Analysis > ModelCHECK** to interactively run ModelCHECK on the current model. The **ModelCHECK** menu appears.
2. Click **ModelCHECK Interactive** to check your model quickly.
3. Click **ModelCHECK Regenerate** to run all ModelCHECK checks, additional checks, and to regenerate the model.

Note: ModelCHECK Regenerate can take some time to complete.

Determine which checks should run during Interactive mode by setting options in the check configuration file.

Interactive Mode Checks Using ModelCHECK Regenerate

When you click **Analysis > ModelCHECK > ModelCHECK Regenerate**, the following checks, in addition to the ModelCHECK checks, are run in Pro/ENGINEER:

In Part Mode

- Regenerates the model in the same way as when you click **Utilities > Model Player > Regenerate features > Finish** in Pro/ENGINEER. This ensures that the part can be fully regenerated and, if necessary, prints warning messages in the ModelCHECK report.
- Verifies all instances if the part is a generic representative of a family.
- Checks that all simplified representations can be regenerated.
- Checks that all cross-sections can be regenerated.

Note: All the above part mode checks are run in **ModelCHECK Regenerate**. You cannot choose to not run any of the above checks.

In Assembly Mode

- Regenerates the top-level assembly and components as selected.

- Verifies all instances if the assembly is a generic representative of a family if the `MCREGEN_VERIFY_FT_INSTS` configuration option in the `config_init.mc` file is set to `Y`.

In Drawing Mode

- Regenerates all views in Drawing mode.
- Reports any missing dimensional references (set the `REGEN_DIM` check in the check configuration file).
- Performs all the checks for Part mode if you choose to run **ModelCHECK Regenerate** on the drawing models.

To Run ModelCHECK in Regenerate Mode

Perform the following steps to run ModelCHECK when the model is regenerated:

1. Set the `MODE_RUN` configuration option to `Y` in the Regenerate Mode (R) column of the `config_init.mc` file.
2. Regenerate your Pro/ENGINEER model.

If ModelCHECK runs successfully, a message appears in the Pro/ENGINEER window. If errors or warnings are found, ModelCHECK generates a report in your Web browser.

Note: You should configure ModelCHECK to run only the most important checks in Regenerate mode (such as buried feature check, children of rounds check) and not the information checks. ModelCHECK then notifies you only when there is a critical mistake.

To Run ModelCHECK in Save Mode

Perform the following steps to run ModelCHECK when the model is saved:

1. Set the `MODE_RUN` option to `Y` in the Save Mode (S) column of the `config_init.mc` file.
2. Set the `SAVE_MC_PRE` option in the `config_init.mc` file to:
 - `Y` - To run ModelCHECK before you save.
 - `N` - To run ModelCHECK after you save.
3. Save the Pro/ENGINEER model.

Note: To ensure that the parameters ModelCHECK writes to the model are saved with it, set the `SAVE_MC_PRE` option to `Y`.

About Running ModelCHECK in Batch Mode

You can run ModelCHECK on a batch of models in the following ways:

- Using Batch mode of ModelCHECK

In this method, ModelCHECK is run using a text file that has the list of models to be checked. The procedure is different for the supported UNIX and Windows platforms. The models to be checked must be stored on disk.

- Using Distributed Pro/BATCH

In this method, ModelCHECK is run through Distributed Pro/BATCH. You can directly select the models to be checked or select the files that list the models to be checked.

Note: You must have a license for Distributed Pro/BATCH.

To Run ModelCHECK in Batch Mode on UNIX

1. Open a UNIX command window.
2. Create a text file in which you list the models you want checked. The text file must have the `.txt` extension. There must be one model file name per line.

Note: You can also check a single model. In this case, a text file is not necessary.

3. Type `<command to start modelcheck> <command to start Pro/ENGINEER> -f <file>.txt` where `<file>.txt` is the name of a text file listing the models. If the `<file>.txt` file is not in the current directory, specify the complete path of the file. A summary report appears listing the models checked and the number of problems found.

Note:

- To check a single model, omit the `-f` option. Specify the name of the model or the path if it is in a different directory.
- If the start commands are unknown, specify the complete path of the shell scripts to start ModelCHECK and Pro/ENGINEER. The shell scripts are in the `bin` directory in the Pro/ENGINEER loadpoint. The default start commands are `modelcheck` and `proe`, respectively. However, the names of the commands can be customized during installation. The names of the commands are generally the same as the names of the shell scripts.

For example, type one of the following commands:

```
modelcheck proe -f <file>.txt
```

```
<proengineer-loadpoint>/bin/modelcheck <proengineer-loadpoint>/bin/proe -f <file>.txt
```

4. In the summary report, click a listed model name to see that model's ModelCHECK report.

Example: Text File for Batch Mode

If the <file>.txt file has the following lines:

```
part1.prt
part2.prt
asm1.asm
drw.drw
```

ModelCHECK checks the four named models and creates reports for each one.

Two methods for creating the text files follow:

- Type: `ls -l *.prt.* *.asm.* *.drw.* > parts.lst`
- Write a shell program to automatically run ModelCHECK in Batch mode on every file in a directory. It looks like the following lines:

```
ls -l *.prt.* *.asm.* *.drw.* > /tmp/parts.lst
mc -f /tmp/parts.lst
rm /tmp/parts.lst
```

To Run ModelCHECK in Batch Mode on Windows

1. Click **Programs > Pro ENGINEER > ModelCHECK.**

Note: Alternatively, run the batch file for ModelCHECK from the `bin` directory in the Pro/ENGINEER loadpoint to start ModelCHECK. The default batch file for ModelCHECK is `modelcheck.bat`.

2. Select the model on which you want to run ModelCHECK or select a text file that specifies a list of file names.
3. Type the command to start Pro/ENGINEER.

Note: If the command to start Pro/ENGINEER is not known, browse to the `bin` directory in the Pro/ENGINEER loadpoint and run the batch file to start Pro/ENGINEER. The default batch file is `proe.bat`, but a different name can be specified during installation.

Note: From a DOS window, you can create a file called `parts.lst` that contains all Pro/ENGINEER models from a specified directory. To do this, type the following command:

```
dir *.prt.* *.asm.* *.drw.* /b > parts.lst
```

To Run ModelCHECK from Distributed Pro/BATCH

You can select ModelCHECK as an operation to be run from Distributed Pro/BATCH.

1. Set the `MC_BATCH_REPORT_DIR` environment variable to a directory where the ModelCHECK report files must be written.

Note: If you do not set the `MC_BATCH_REPORT_DIR` environment variable or if the specified directory does not have write permissions, Distributed Pro/BATCH writes the report files to the output directory specified in the ModelCHECK task group.

2. Start Distributed Pro/BATCH.
3. Select the models to be checked or select a text file, or files, having the list of models to be checked.
4. Choose whether you want ModelCHECK to run on the current computer or across several computers.

Note: To run ModelCHECK across several computers, each computer must have a ModelCHECK and Pro/ENGINEER license. If a computer does not have a license, the Distributed Services Queue Manager reassigns the task appropriately. ModelCHECK ensures that the correct configuration files are used and the reports are stored in the appropriate directories.

5. Run the batch process. ModelCHECK generates and writes reports for each model to the specified directory.
6. In your Web browser, browse to the required ModelCHECK report file and open it. The report is similar to the report generated in Interactive mode.

See the Distributed Pro/BATCH Help for details about running ModelCHECK from Distributed Pro/BATCH.

Automatic Corrections in Batch Mode

The following automatic corrections are performed in Batch mode:

- Adds items to layers
- Adds relations and comments
- Changes the layer display status
- Creates layers
- Deletes extra layers
- Creates parameters (if their values are known)
- Deletes extra parameters
- Fully regenerates the model from the first feature and reports any problems
- Moves items between layers
- Designates parameters for PDM tools
- Renames datums
- Renames layers
- Saves the model

These corrections are performed in the ModelCHECK Batch mode as well as when ModelCHECK is run through Distributed Pro/BATCH. ModelCHECK automatically checks a corrected model a second time to update the reports and save the model.

Note: If ModelCHECK is run in Batch mode, a Pro/ENGINEER license is required, because the models must be accessed in Pro/ENGINEER.

About ModelUPDATE Mode

The ModelUPDATE mode allows you to automatically update models for errors generated during ModelCHECK. All the updates possible from the ModelCHECK report that do not require manual interaction such as typing or selection are automatically performed in ModelUPDATE mode. A report of successful and failed updates is generated. You can configure ModelUPDATE mode using the ModelCHECK configuration files.

Note: You can run ModelUPDATE only in the ModelCHECK Interactive mode.

To Run ModelCHECK in ModelUPDATE Mode

1. Set the `MU_ENABLED` configuration option in the `config_init.mc` file to `Y`.
2. Click **Analysis > ModelCHECK > Load Config** and select the configuration if you have configured ModelCHECK to manually select the configuration.
3. Click **Analysis > ModelCHECK > ModelCHECK Interactive** to update your model.

Configuring ModelCHECK

About Configuring ModelCHECK

You can configure ModelCHECK to run different checks at different times. For example:

- **ModelCHECK Interactive** - Checks the currently active model.
- **ModelCHECK Regenerate** - Regenerates the active model and then checks it.

You can also configure ModelCHECK to report problems using the **PTC ModelCHECK Configuration Tool** dialog box.

The following text files store the configuration options:

- `config_init.mc` (initialization file)
- `condition.mcc` (condition file)
- `setconf.mcc` (condition file)
- `<filename>.mch` (check configuration file)
- `<filename>.mcs` (start configuration file)

ModelCHECK - Help Topic Collection

- <filename>.mcn (constant configuration file)
- <filename>.mcq (status configuration file)

In addition, the following text files store the values required while checking models:

- <filename>.txt (external file)
- <filename>.mcg (group file)

The configuration files are located in <modelcheck-loadpoint>/text/<language>/config.

Use the MCDIR environment variable to specify an alternative location for the config directory. Files in the alternative location override the default settings.

Use the **PTC ModelCHECK Configuration Tool** dialog box to set the configuration options in the ModelCHECK configuration files or manually edit the configuration files.

The **PTC ModelCHECK Configuration Tool** dialog box allows you to:

- Access the existing and newly created configuration files from the left pane of the dialog box.
- Select items from boxes to set options in the ModelCHECK configuration files.
- Copy and paste items using the right-click.
- Save the configuration files. You can also store the earlier versions of the configuration files using the DIR_MC_BACKUP_CONFIG configuration option in the config_init.mc file.
- Create configuration files.
- See the list of ModelCHECK configuration files for the current model.
- See the help for the configuration files at the top of the right pane and the details of the configuration options in the browser.

To Configure ModelCHECK

1. Click **Tools > Configure ModelCHECK**. The **PTC ModelCHECK Configuration Tool** dialog box opens.
2. Use the **PTC ModelCHECK Configuration Tool** dialog box to set the options in the ModelCHECK configuration files. See the topics in the See Also section for details about the files.
3. Click **List Configs** to see the list of ModelCHECK configuration files for the current model in the right pane of the **PTC ModelCHECK Configuration Tool** dialog box.

Note: **List Configs** is available only when you open a model.

- Click **Close Window** to close the **PTC ModelCHECK Configuration Tool** dialog box.

Note:

- The system administrator can limit access to the configuration files using file permissions. The **PTC ModelCHECK Configuration Tool** recognizes the permissions and does not allow unauthorized access to the configuration files. The system administrator can also limit access to the configuration files using the `MC_AUTHORIZATION_FILE` configuration option in the `config_init.mc` file.
- Changes to the configuration files are not effective unless you save the files.

Example: ModelCHECK Configuration Files Flow Chart

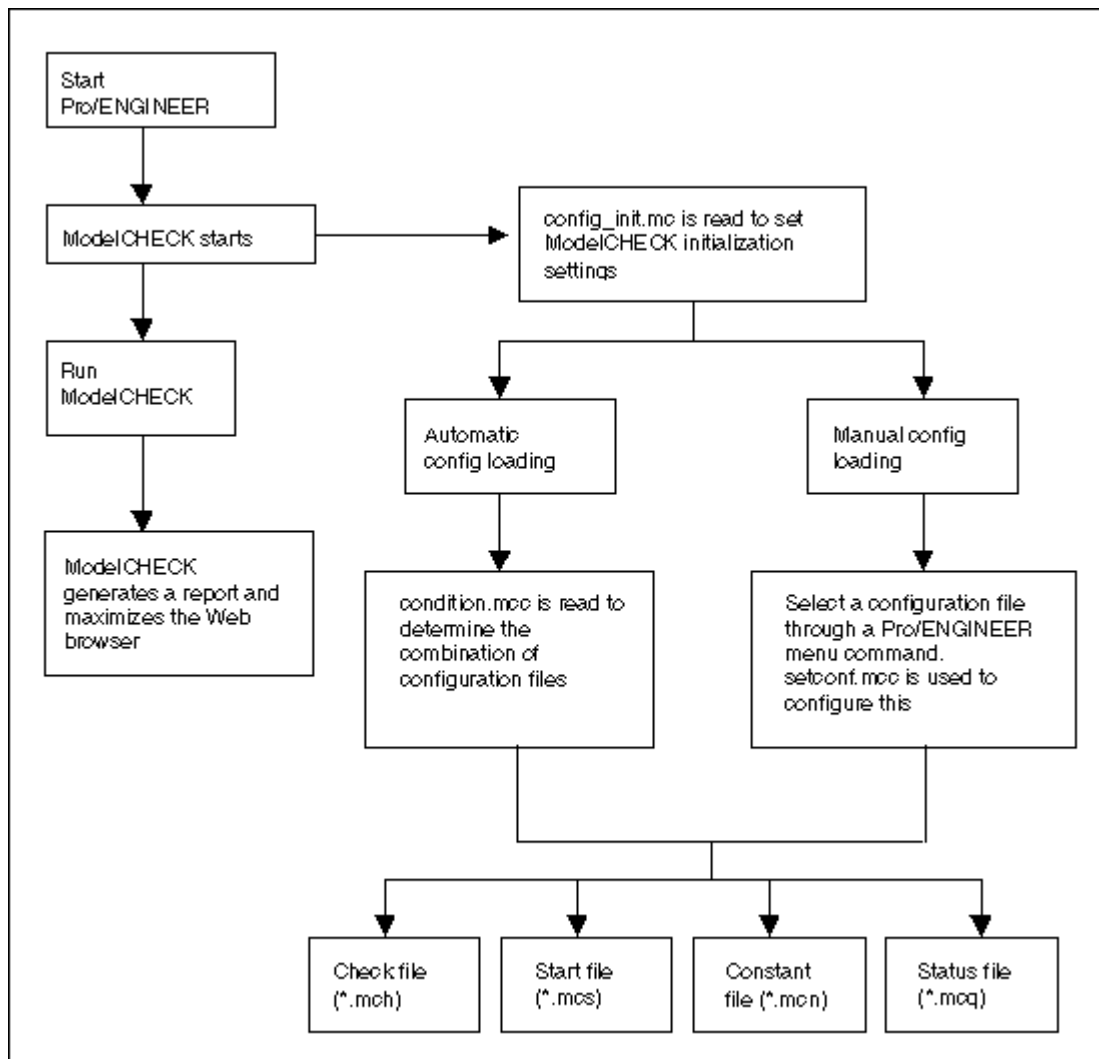

Controlling Access to the Configuration Files

The system administrator can control access to the ModelCHECK configuration files in two ways:

- Using file permissions at the operating-system level.

Users may have limited access to all or particular configuration files. However, all users can choose the configuration condition from the Pro/ENGINEER **Load Config** menu and use **List Configs** in the **PTC ModelCHECK Configuration Tool**.

- Using an external text file (`external_access.txt`) to control access.

The `MC_AUTHORIZATION_FILE` configuration option in the `config_init.mc` file indicates the use of the external file. ModelCHECK uses `external_access.txt` only if you have set the `MCDIR` environment variable. The file is located in the `text` subdirectory in the `config` directory specified by the `MCDIR` environment variable.

Users are classified and listed according to their roles. Administrators have full access to all configuration files while regular users have no access to the configuration files. Regular users may only choose a configuration condition, access `GeomIntegrityCHECK`, and use **List Configs**.

A sample text file follows:

```
# ModelCHECK authorization file
#####
#User List
#####*#####
LIST_ADMINISTRATOR mfisher
LIST_ADMINISTRATOR administrator
LIST_ADMINISTRATOR demo
#####
#User List
#####
LIST_USER viarora
LIST_USER wtaylor
LIST_USER ngohil
LIST_USER rjain
```

About Integrating ModelCHECK with a PDM System

You can exchange information about a model between ModelCHECK and a PDM system.

- You can configure ModelCHECK to update four parameters in the model file when ModelCHECK is run on the model after modifying the model:
 - `MODEL_CHECK` - (string) The date and time that ModelCHECK was last run.
 - `MC_ERRORS` - (integer) The number of errors found.

- `MC_CONFIG` - (string) The name or names of the configuration file or files used.
- `MC_MODE` - (string) The mode in which ModelCHECK was run; Interactive, Regenerate, Save, Batch, or MC Regen.

Note: You can view the values of these parameters but not change them. ModelCHECK does not update the parameters if the model has not been modified. If the parameters are not available in the model, ModelCHECK adds them regardless of whether the model has been modified or not.

To see these parameters from within Pro/PDM or Pro/INTRALINK, attributes with the same names and types must be created from within Pro/PDM or the Pro/INTRALINK Commonsense using the Pro/ADMIN tool.

You can then program Pro/INTRALINK to allow the check-in of only those models with the previous parameters set to specified values. For example, you can write a trigger to deny the check-in of models with errors (`MC_ERRORS` is greater than 0.)

- You can configure ModelCHECK to use the Pro/INTRALINK Commonsense to store the shape information for models. The shape information is stored in seven parameters (`MC_SI1` to `MC_SI7`) for use in searches for duplicate models. ModelCHECK creates and designates these parameters if you set the `INTRALINK_DUPINFO` configuration option in the `config_init.mc` file to `Y`.
- Alternatively, you can configure ModelCHECK to use the Windchill database to store the shape information for models. The shape information is stored in five mass property parameters (`PRO_MP_VOLUME`, `PRO_MP_AREA`, `PRO_MP_IXX`, `PRO_MP_IYY`, and `PRO_MP_IZZ`) for use in searches for duplicate models. These parameters are available in the model when the model is created. ModelCHECK designates these parameters if you set the `WC_DUPINFO` configuration option in the `config_init.mc` file to `Y`.

Note: The mechanisms for storing the shape information in the Pro/INTRALINK Commonsense and the Windchill database are completely independent of each other.

Using ModelCHECK with Windchill

You can use ModelCHECK to verify the models being checked into the Windchill database. Windchill allows you to check in a model only when the model meets the design standards.

Windchill uses the `MODEL_CHECK`, `MC_ERRORS`, and `MC_CONFIG` parameters to create corresponding instance-based attributes (IBAs) when the model is uploaded to the Windchill server.

You can create a ModelCHECK filter in Windchill to define the values that the IBAs must have for a successful check-in. During the check-in process, Windchill uses the filter to verify whether the values of the IBAs match the requirements.

If the model does not meet the requirements, Windchill generates a report specifying the reasons. After updating the model, click **Run ModelCHECK Now** in the report to

run ModelCHECK again. Use the ModelCHECK filter to define the configuration files that ModelCHECK must use for models that have failed the check-in.

Note: You can run ModelCHECK from the report only if you check in the model from Pro/ENGINEER.

You can also configure ModelCHECK to use the Windchill database to store the shape information for models. The shape information is stored in five mass property parameters for use in searches for duplicate models.

Setting Up the Initialization File: config_init.mc File

About the config_init.mc File

Use the `config_init.mc` file to specify initialization settings for ModelCHECK. This file is read when Pro/ENGINEER starts and ModelCHECK initializes. If you make changes to the file, you must restart Pro/ENGINEER.

To Set Up the config_init.mc File Using the PTC ModelCHECK Configuration Tool

1. Click  adjacent to **Initialization settings** in the left pane of the **PTC ModelCHECK Configuration Tool** dialog box.
2. Click **Edit config_init.mc**. A table listing all the configuration options in the `config_init.mc` file and their values appears in the right pane of the **PTC ModelCHECK Configuration Tool** dialog box. The configuration options are divided into three sections according to the values to which you can set the options.
3. Edit the configuration options and their values using the boxes.

You can add and delete rows to add and delete configuration options, respectively.

4. Click **Save**.

Note: Changes to the `config_init.mc` file are not effective in the current Pro/ENGINEER session. Restart Pro/ENGINEER.

To Manually Set Up the config_init.mc File

1. Open the `config_init.mc` file using a text editor. This file exists in `<proengineer-loadpoint>/modchk/text/<language>/config` or in the directory you have specified with the `$MCDIR` environment variable.
2. Set the options to a value for each ModelCHECK mode. Each mode is in a separate column. The modes are abbreviated as follows:
 - I - Interactive
 - B - Batch

- R - Regenerate
 - S - Save
3. Set values for all initialization options.
- Note:** You can use spaces in the name of a directory without enclosing it in quotes.
4. Restart Pro/ENGINEER each time you enter or change a value in the `config_init.mc` file.

Configuration Options in the `config_init.mc` File

The option name, values to which it can be set, and a definition are listed alphabetically for each configuration option in the `config_init.mc` file.

- `ADD_CONFIG_PARM`
<Y/N/A>
- `ADD_DATE_PARM`
<Y/N>
- `ADD_DUP_INFO_AUTO`
<Y/N/A/D>
- `ADD_ERR_PARM`
<Y/N>
- `ADD_MODE_PARM`
<Y/N/A>
- `ADD_MU_STAMP`
<Y/N>
- `ASM_BATCH_ALL`
<Y/N>
- `ASYNC_PORT`
<integer>
- `BURIED_ADVANCED`
<Y/N>
- `CHECK_ALL_MODELS`
<Y/N>
- `CNFG_SELECT_AUTO`
<Y/N/A>

ModelCHECK - Help Topic Collection

- DESIGNATE_MU_STAMP
<Y/N>
- DIR_MC_BACKUP_CONFIG
<directory path>
- DIR_MC_BACKUP_CONFIG_NT
<directory path>
- DIR_MC_BACKUP_CONFIG_U
<directory path>
- DIR_MC_DUP_READ
<directory path>
- DIR_MC_DUP_READ_NT
<directory path>
- DIR_MC_DUP_READ_U
<directory path>
- DIR_MC_DUP_WRITE
<directory path>
- DIR_MC_DUP_WRITE_NT
<directory path>
- DIR_MC_DUP_WRITE_U
<directory path>
- DIR_MC_PREVIEW
<directory path>
- DIR_MC_PREVIEW_NT
<directory path>
- DIR_MC_PREVIEW_U
<directory path>
- DIR_METRICS
<directory path>
- DIR_METRICS_NT
<directory path>

- DIR_METRICS_U
<directory path>
- DIR_REPORT
<directory path>
- DIR_REPORT_NT
<directory path>
- DIR_REPORT_U
<directory path>
- DRW_SHEET_ALL
<Y/N/A>
- HIGHLIGHT_COLOR
<Yellow/White/Gray/Blue/Red/Magenta/Cyan/Green/Brown>
- HTML_FILE_OUTPUT
<Y/N>
- HTML_FILE_OUTPUT_REPXSL
<path>
- HTML_MAX_DAYS
<Integer>
- ILNK_MC_DUP_FLDR
<directory path>
- ILNK_MC_PRVW_SCRPT
<path>
- ILNK_MC_SRCH_SCRPT
<path>
- INTRALINK_DUPINFO
<Y/N>
- MC_AUTHORIZATION_FILE
<Y/N>
- MC_ENABLE
<Y/N/A>

ModelCHECK - Help Topic Collection

- MC_METRICS
<Y/N>
- MC_VDA_RUN
<Y/N>
- MCREGEN_VERIFY_FT_INSTS
<Y/N>
- MODE_RUN
<Y/N>
- MODE_UPDATE
<Y/N>
- MU_ENABLED
<Y/N>
- MU_REGENERATE
<Y/N>
- NUM_ITEMS_LONG_LIST
<Integer>
- PARENT_HI_COLOR
<Yellow/White/Gray/Blue/Red/Magenta/Cyan/Green/Brown>
- PROGRAM
<Pro/ENGINEER start command>
- SAVE_MC_PRE
<Y/N>
- SAVE_MU
<Y/N>
- SHOW_REPORT
<Y/N>
- SKIP_MODELS
<Y/N>
- UPDATE_INTER_ASM
<Y/N>

- UPDATE_SHEETMETAL
<Y/N>
- UPDATE_SKELETON
<Y/N>
- WC_DUPINFO
<Y/N>

Example: config_init.mc File

The config_init.mc file is formatted in six columns: The name of the option (MODE_RUN for example), the values you can set it to (YN for example), the value it is set to in interactive (I), batch (B), regenerate (R), and save (S) modes.

```
! -----
#           Options           "I"      "B"      "R"      "S"
! -----

# Enable ModelCHECK Y=enable, N=disable, A=Ask user
MC_ENABLE      YNA           Y
# Enable/Disable ModelCHECK in specific modes
MODE_RUN       YN           Y      Y      N      N
# Automatically update errors in models when run in BATCH
MODE_UPDATE    YN           Y      Y      Y      Y
# Enable/Disable ModelCHECK metrics in specific modes
MC_METRICS     YN           Y      Y      Y      Y
# Directory ModelCHECK will write reports on NT
#DIR_REPORT_NT $TEMP/mc_reports
# Directory ModelCHECK will write reports on UNIX
DIR_REPORT_U   /tmp/mc_reports
# Directory ModelCHECK will write reports
#DIR_REPORT    $TEMP/mc_reports
# Directory ModelCHECK will write metrics flat file on NT
#DIR_METRICS_NT $TEMP/mc_metrics
# Directory ModelCHECK will write metrics flat file on UNIX
DIR_METRICS_U  /tmp/mc_metrics
# Directory ModelCHECK will write metrics flat file
#DIR_METRICS   $TEMP/mc_metrics
# Directory ModelCHECK will read shape indexing files on NT
DIR_MC_DUP_READ_NT $TEMP/mc_dup_read
# Directory ModelCHECK will read shape indexing files on UNIX
DIR_MC_DUP_READ_U  /tmp/mc_dup_read
# Directory ModelCHECK will read shape indexing files
DIR_MC_DUP_READ  $TEMP/mc_dup_read
# Directory ModelCHECK will write shape indexing files on NT
#DIR_MC_DUP_WRITE_NT $TEMP/mc_dup_write
# Directory ModelCHECK will write shape indexing files on UNIX
```

ModelCHECK - Help Topic Collection

```
DIR_MC_DUP_WRITE_U /tmp/mc_dup_write
# Directory ModelCHECK will write shape indexing files
#DIR_MC_DUP_WRITE $TEMP/mc_dup_write
# Directory ModelCHECK will keep the backup of config files on NT
#DIR_MC_BACKUP_CONFIG_NT $TEMP/mc_backup_config
# Directory ModelCHECK will keep the backup of config files on UNIX
#DIR_MC_BACKUP_CONFIG_U /tmp/mc_backup_config
# Directory ModelCHECK will keep the backup of config files
#DIR_MC_BACKUP_CONFIG $TEMP/mc_backup_config
# Use the external file for authorization to use Configurator Tool
MC_AUTHORIZATION_FILE YN N
# Asynchronous port for ModelCHECK server to use
ASYNC_PORT 3001
# Number of days to save html and xml files in DIR_REPORT
HTML_MAX_DAYS 1
# Auto add/upd parameter MODEL_CHECK to model with current date as it's
value
ADD_DATE_PARM YN N N N N
# Auto add/upd parameter MC_ERRORS to model with number of errors found
in model
ADD_ERR_PARM YN N N N N
# Auto add/upd parameter MC_CONFIG to model with current mc config used
ADD_CONFIG_PARM YN N N N N
# Auto add/upd parameter MC_MODE to model with current mode MC was run
ADD_MODE_PARM YN N N N N
# Skip models in assemblies if they have not changed since being
retrieved
# regardless of what MC_ERRORS is set to
SKIP_MODELS YN N
# Check models in assemblies regardless of whether they have changed
since
# being retrieved or not
CHECK_ALL_MODELS YN N
# Interactive SAVE MODE - pre (Y) or post (N)?
SAVE_MC_PRE YN N
# ASSEMBLY batch mode - run TOP only (N) or ALL LEVELS (Y)
ASM_BATCH_ALL YN Y
# Run MC on all drawing sheets (Y) or current only (N)
DRW_SHEET_ALL YN Y Y Y Y
# Config select Mode - Automatic (Y) or Load Config menu option (N)
# or Ask User at start of Pro/E session (A)
CNFG_SELECT_AUTO YNA Y
# Enable/Disable MC_VDA for specific mode
MC_VDA_RUN YN Y Y N N
# Highlight Color (Red, Yellow, White, Blue, Grey, Magenta, Cyan, Green, Brown)
HIGHLIGHT_COLOR Blue
PARENT_HI_COLOR Red
# Duplicate models - Automatically add dup model info to text file
# Y - always add model info
```



```

# N - Never add model info
# D - add model info but Don't overwrite existing info
# A - always Ask the user whether to add AND whether to overwrite
ADD_DUP_INFO_AUTO YNDA          N N N N
INTRALINK_DUPINFO YN           N
#ILNK_MC_SRCH_SCRIPT <proitkenv_load_pt>/bin/<script_to_exec_mcilsearch>
#ILNK_MC_PRVW_SCRIPT <proitkenv_load_pt>/bin/<script_to_exec_mcilchkout>
#ILNK_MC_DUP_FLDR    folder1
#ILNK_MC_DUP_FLDR    folder2
#ILNK_MC_DUP_FLDR    folder3
# Temporary directory for preview files storage
#DIR_MC_PREVIEW_NT   $TEMP/mc_preview
# Temporary directory for preview files storage
DIR_MC_PREVIEW_U    /tmp/mc_preview
# Temporary directory for preview files storage
#DIR_MC_PREVIEW     $TEMP/mc_preview
# Advance buried feature analysis
BURIED_ADVANCED    YN           N
# Show Report
SHOW_REPORT        YN           Y         Y         Y         Y
# PROGRAM NAMES
PROGRAM            pro
HTML_FILE_OUTPUT   YN           Y         Y         Y         Y

```

Duplicate Models in ModelCHECK

About Duplicate Models

ModelCHECK searches for duplicate parts by examining a model's shape and then searching the database for similar models.

Note: The `DUPLICATE_MODELS` check in the check configuration file must be active for ModelCHECK to report duplicate models.

A line item in the ModelCHECK report indicates duplicate models. Click the line item for the names of the models found. The following information appears:

- Percent match
- Model units
- Number of features
- Number of datums
- Size of the model (height x width x length)

Click  in the ModelCHECK report to see the selected model without having to open it in Pro/ENGINEER. You can also spin, pan, and zoom the model in the preview window.

About Storing Shape Information

You can use the `config_init.mc` file to configure how and where ModelCHECK stores shape information. ModelCHECK also allows you to use the Pro/INTRALINK Commonsense or the Windchill database to store the shape information for models.

If you choose not to use Pro/INTRALINK or Windchill, the `mc_dup_model.bin` file is used for reading shape information. The `DIR_MC_DUP_READ` configuration option in the `config_init.mc` file specifies the path to the `mc_dup_model.bin` file.

When you exit Pro/ENGINEER after running ModelCHECK on a model, the shape indexing information is stored in the `mc_dupl_<username>_yyyymmddhhmm.bin` file in the path specified by the `DIR_MC_DUP_WRITE` configuration option in the `config_init.mc` file. Ensure that the `mc_dupl_<username>_yyyymmddhhmm.bin` files are regularly combined with the `mc_dup_model.bin` file.

To Create the `mc_dup_model.bin` File

1. Download the `mc_si_merge_20000716.exe` (Windows NT) or `mc_si_merge_20000716.sun` (UNIX) utilities from `ftp.ptc.com/utills/shape_ind/` to the directory specified by the `DIR_MC_DUP_WRITE` configuration option. Use `mccust` and `mc21` as the user name and password, respectively.

2. Create a file with a list of all the files to be combined with the `mc_dup_model.bin` file using one of the following commands:

```
ls -l mc_dupl* > list.txt (on UNIX)
```

```
dir /b mc_dupl* > list.txt (on DOS)
```

3. Combine the files with the following command:

```
mc_si_merge_20000716.exe mc_dup_model.bin [-z] [-f <list.txt>]
```

where `z` is used to zoom or change the default value of the search criteria. ModelCHECK uses a number of shape indexing parameters to compare models to one another. Two models are considered similar if the values of their corresponding parameters are within a specific percentage of each other. This percentage is called the search criteria. The value of the search criteria is 5% by default.

4. Specify a value for the search criteria. The maximum value is 10%.

Note: If you type a new value for the search criteria, the old value is multiplied by the new value. If `-z` is not used in the merge command, you cannot enter a new value and the existing value is used.

A new `mc_dup_model.bin` file is created in the current directory or appended to an existing file.

5. Copy the created `mc_dup_model.bin` file to the directory specified by the `DIR_MC_DUP_READ` configuration option.

Note: When information is added to the `mc_dup_model.bin` file, ModelCHECK searches the file for models with the same name. If a model with the same name is found, its information is overwritten with the latest information.

About Using the Windchill Database

Using the Windchill database allows you to store shape information for different versions of each model. Set the `WC_DUPINFO` configuration option in the `config_init.mc` file to `Y` to store the shape information for models in the Windchill database.

When you run ModelCHECK on a model, the following mass property parameters are automatically designated, if they are not already designated:

- Volume (`PRO_MP_VOLUME`)
- Surface area (`PRO_MP_AREA`)
- Principal Moment of Inertia 1 (`PRO_MP_IXX`)
- Principal Moment of Inertia 2 (`PRO_MP_IYY`)
- Principal Moment of Inertia 3 (`PRO_MP_IZZ`)

These parameters are available as Reported Mass Properties parameters in the **Parameters** dialog box.

When you save a model, these parameters, which are designated parameters, store the shape attributes. These parameters are automatically stored as system parameters in the Windchill database when you check in the model.

Note: The Windchill Database Administrator must create the instance-based attributes (IBAs) for these parameters and they must be of type real number with no default values. The Windchill Database Administrator must define the types for the IBAs using the Type Manager and give permissions to change the values.

ModelCHECK uses the shape attributes stored in the Windchill database to search for duplicate models. The `SEARCH_DUP_MODELS` check searches for the duplicate models. You can specify the tolerance percentage for the attributes using options in the constant configuration file (`MCSI1_TOL` through `MCSI5_TOL`). Only those models with all the attributes within the tolerance range are considered as duplicate models and are reported. The report is displayed in Windchill.

Note:

- The search for duplicate models is performed only on the active Windchill server registered in Pro/ENGINEER. Registered servers that are not active are not searched. When you run ModelCHECK, the `SEARCH_DUP_MODELS` check provides a **Search** for the active Windchill server in the ModelCHECK report. Click **Search** in the ModelCHECK report to search the server for duplicate models and their details. If there is no active server, **Search** is not available in the ModelCHECK report and ModelCHECK displays a message.
- The search for duplicate models is performed only on the Windchill database and not the workspaces. However, models in the workspaces are valid for the search if they are in the uploaded state.

- The search for duplicate models is not performed on legacy models in which the mass property parameters are not available, or designated, or not compatible with the parameters required for the search.
- PTC recommends that the current Pro/ENGINEER model and the models in the Windchill database are in the same units.

About Using the Pro/INTRALINK Commonspace

Using the Pro/INTRALINK Commonspace allows you to store shape information for different versions of each model. Set the `INTRALINK_DUPINFO` configuration option in the `config_init.mc` file to `Y` to store the shape information for models in the Pro/INTRALINK Commonspace. In addition, set the `ADD_DATE_PARM`, `ADD_ERR_PARM`, `ADD_CONFIG_PARM`, `ADD_MODE_PARM`, and `ADD_DUP_INFO_AUTO` configuration options in the `config_init.mc` file to `Y`.

Note: Pro/INTRALINK Client and Pro/INTRALINK TOOLKIT must be installed and you must have a Pro/INTRALINK TOOLKIT access license. In addition, you must set the `PDM_LDB_PATH` environment variable to the path of the directory containing the `.proi` directory.

When ModelCHECK runs on a model, the following read-only parameters (in addition to `MODEL_CHECK`, `MC_ERRORS`, `MC_CONFIG`, and `MC_MODE`) are created in Pro/ENGINEER:

- Volume (`MC_SI1`)
- Surface area (`MC_SI2`)
- Principal Moment of Inertia 1 (`MC_SI3`)
- Principal Moment of Inertia 2 (`MC_SI4`)
- Principal Moment of Inertia 3 (`MC_SI5`)
- Parameter for units (`MC_SI6`)
- Parameter for length and mass conversion factors (`MC_SI7`)

When a model is saved, these parameters store the shape attributes. These parameters are automatically stored as versioned object attributes in the Pro/INTRALINK Commonspace when you check in the model.

Note: The Pro/INTRALINK Database Administrator must create the versioned attributes of type string with no default values and also give permissions to change the values.

ModelCHECK uses the versioned or life-cycle (for legacy parts) shape attributes stored in the Commonspace to search for duplicate models. You can specify the tolerance percentage for the attributes using options in the constant configuration file. Only those models with all the attributes within the tolerance range are considered as duplicate models and are reported.

For models with family tables, the parameters `MC_SI1` through `MC_SI7` are added to the family table when ModelCHECK is run on the generic model. For the shape

information of all instances to be available in the Pro/INTRALINK Commonsense, you must verify the family table before checking the model into Pro/INTRALINK.

Note: Family table verification changes the model resulting in a new version of the model in Pro/INTRALINK.

About Using the Pro/INTRALINK Commonsense for Legacy Models

Shape attributes for legacy models are stored as life-cycle attributes. These attributes allow addition of shape information to the Pro/INTRALINK Commonsense without creating a new version.

Note: The Pro/INTRALINK Database Administrator must create the life-cycle attributes of type string with no default values for the shape parameters and also give permissions to change the values.

To Set Up the mcilupdLCA Application

You can use the Pro/INTRALINK application, `mcilupdLCA`, to read the versioned object attributes of legacy models checked out into your Workspace and update the corresponding life-cycle attributes in the Pro/INTRALINK Commonsense. Before using this application, checkout the required earlier versions of the legacy models, run ModelCHECK on all legacy models in the Workspace and save them to ensure creation of the versioned object attributes.

1. Copy the Pro/INTRALINK TOOLKIT execution script or batch file and save it as:

```
mcilupdLCA.sh (UNIX) or
```

```
mcilupdLCA.bat (Windows NT)
```

Note: The Pro/INTRALINK TOOLKIT execution script is located in the `bin` directory of the Pro/INTRALINK TOOLKIT loadpoint.

2. Add the following lines to the beginning of the `mcilupdLCA.sh` or `mcilupdLCA.bat` files:

```
setenv PDM_USER <Intralink_user>
setenv PDM_PASSWD <Intralink_passwd> (UNIX)
```

or

```
set PDM_USER=<Intralink_user>
set PDM_PASSWD=<Intralink_passwd> (Windows NT)
```

where `<Intralink_user>` and `<Intralink_passwd>` are the Pro/INTRALINK user name and password respectively.

For example:

- o On the Solaris operating system, add the following lines to the `mcilupdLCA.sh` script:

```
setenv PDM_USER INTRALINK
setenv PDM_PASSWD INTRALINK
```

- o On Windows NT, add the following lines to the `mcilupdLCA.bat` batch file:

```
set PDM_USER=INTRALINK
set PDM_PASSWD=INTRALINK
```

3. Add the following line to the `mcilupdLCA.sh` or `mcilupdLCA.bat` files:

```
<Pro/ENGINEER_load_point>/<machine_type>/obj/mcilupdLCA $* (UNIX) or
<Pro/ENGINEER_load_point>\<machine_type>\obj\mcilupdLCA.exe %1 %2
(Windows NT)
```

Note: On Windows NT, you must add the above line just before `:ptc_end`.

For example:

- o On the Solaris operating system, add the following line to the `mcilupdLCA.sh` script:

```
<Pro/ENGINEER_load_point>/sun4_solaris/obj/mcilupdLCA $*
```

- o On Windows NT, add the following line to the `mcilupdLCA.bat` batch file:

```
<Pro/ENGINEER_load_point>\i486_nt\obj\mcilupdLCA.exe %1 %2
```

4. Specify the name of the Workspace where you have checked out the legacy models and have run ModelCHECK on them, as the argument to the script.

This updates the life-cycle attributes in the Pro/INTRALINK Commonsense for the checked-out versions.

Note: Do not checkin the legacy models as this creates a new version. Instead, delete them from the Workspace.

To Set Up the `mcilsearch` Application

The `mcilsearch` application searches for duplicate models.

1. Copy the Pro/INTRALINK TOOLKIT execution script or batch file and save it as:

```
mcilsearch.sh (UNIX) or
```

```
mcilsearch.bat (Windows NT)
```

Note: The Pro/INTRALINK TOOLKIT execution script is located in the `bin` directory of the Pro/INTRALINK TOOLKIT loadpoint.

2. Add the following lines to the beginning of the `mcilsearch.sh` or `mcilsearch.bat` files:

```
setenv PDM_USER <Intralink_user>
setenv PDM_PASSWD <Intralink_passwd> (UNIX)
```

or

```
set PDM_USER=<Intralink_user>
set PDM_PASSWD=<Intralink_passwd> (Windows NT)
```

where `<Intralink_user>` and `<Intralink_passwd>` are the Pro/INTRALINK login id and password respectively.

For example:

- On the Solaris operating system, add the following lines to the `mcilsearch.sh` script:

```
setenv PDM_USER INTRALINK
setenv PDM_PASSWD INTRALINK
```

- On Windows NT, add the following lines to the `mcilsearch.bat` batch file:

```
set PDM_USER=INTRALINK
set PDM_PASSWD=INTRALINK
```

3. Add the following line to the `mcilsearch.sh` or `mcilsearch.bat` files:

```
<Pro/ENGINEER_load_point>/<machine_type>/obj/mcilsearch $* (UNIX) or
<Pro/ENGINEER_load_point>\<machine_type>\obj\mcilsearch.exe %1 %2 %3
(Windows NT)
```

Note: On Windows NT, you must add the above line just before `:ptc_end`.

For example:

- On the Solaris operating system, add the following line to the `mcilsearch.sh` script:

```
<Pro/ENGINEER_load_point>/sun4_solaris/obj/mcilsearch $*
```

- On Windows NT, add the following line to the `mcilsearch.bat` batch file:

```
<Pro/ENGINEER_load_point>\i486_nt\obj\mcilsearch.exe %1 %2
```

4. Set the `ILNK_MC_SRCH_SCRPT` configuration option in the `config_init.mc` file to the path to the `mcilsearch.sh` or `mcilsearch.bat` files.

To Set Up the mcilchkout Application

The `mcilchkout` application allows duplicate models in the Pro/INTRALINK Commonsense to be previewed from the ModelCHECK report.

1. Copy the Pro/INTRALINK TOOLKIT execution script or batch file and save it as:

```
mcilchkout.sh (UNIX) or
```

```
mcilchkout.bat (Windows NT)
```

Note: The Pro/INTRALINK TOOLKIT execution script is located in the `bin` directory of the Pro/INTRALINK TOOLKIT loadpoint.

ModelCHECK - Help Topic Collection

2. Add the following lines to the beginning of the `mcilchkout.sh` or `mcilchkout.bat` files:

```
setenv PDM_USER <Intralink_user>
setenv PDM_PASSWD <Intralink_passwd> (UNIX)
```

or

```
set PDM_USER=<Intralink_user>
set PDM_PASSWD=<Intralink_passwd> (Windows NT)
```

where `<Intralink_user>` and `<Intralink_passwd>` are the Pro/INTRALINK login id and password respectively.

For example:

- o On the Solaris operating system, add the following lines to the `mcilchkout.sh` script:

```
setenv PDM_USER INTRALINK
setenv PDM_PASSWD INTRALINK
```

- o On Windows NT, add the following lines to the `mcilchkout.bat` batch file:

```
set PDM_USER=INTRALINK
set PDM_PASSWD=INTRALINK
```

3. Add the following line to the `mcilchkout.sh` or `mcilchkout.bat` files:

```
<Pro/ENGINEER_load_point>/<machine_type>/obj/mcilchkout $* (UNIX) or
<Pro/ENGINEER_load_point>\<machine_type>\obj\mcilchkout.exe %1 %2
(Windows NT)
```

Note: On Windows NT, you must add the above line just before `:ptc_end`.

For example:

- o On the Solaris operating system, add the following line to the `mcilchkout.sh` script:

```
<Pro/ENGINEER_load_point>/sun4_solaris/obj/mcilchkout $*
```

- o On Windows NT, add the following line to the `mcilchkout.bat` batch file:

```
<Pro/ENGINEER_load_point>\i486_nt\obj\mcilchkout.exe %1 %2
```

4. Set the `ILNK_MC_PRVW_SCRPT` configuration option in the `config_init.mc` file to the path to the `mcilchkout.sh` or `mcilchkout.bat` files.

Setting Up the Condition Files

Setting Up the Condition File: setconf.mcc

About the setconf.mcc File

The `setconf.mcc` file is also referred to as a condition file. When the `CNFG_SELECT_AUTO` configuration option is set to `N` or `A` in the `config_init.mc` file, the `setconf.mcc` file determines what configuration files you can select from the Pro/ENGINEER **Load Config** menu.

To Set Up the setconf.mcc File Using the PTC ModelCHECK Configuration Tool

1. In the `config_init.mc` file, set the `CNFG_SELECT_AUTO` configuration option to `N` or `A` to allow users to decide what configuration files to use. If this option is set to `Y`, the configuration files to use are chosen automatically.
 - `N` - ModelCHECK requires you to choose the configuration files to run
 - `A` - ModelCHECK prompts you to specify whether you want to load the configuration files or let ModelCHECK select them automatically.
2. Click  adjacent to **Conditional settings** in the left pane of the **PTC ModelCHECK Configuration Tool** dialog box.
3. Click **Edit setconf.mcc**. A table listing all the sets of configurations appears in the right pane of the **PTC ModelCHECK Configuration Tool** dialog box. Each set comprises a name and the combination of start, check, constant, and status configuration files.
4. Edit the sets using the boxes.
 - Add and delete rows to add and delete sets, respectively. To add sets, type the name of the set.
 - Add columns to specify more than one start, check, constant, and status configuration files.
 - Delete columns as required.
 - Move rows up or down to order the sets.
5. Click **Save**.
6. Click **Analysis > ModelCHECK > Load Config** in Pro/ENGINEER. The **Load Config** menu appears. If the `setconf.mcc` file is set as in the previous example, the following configurations are listed in the **Load Config** menu: **Automatic, PDM, Light, NoStart**.

7. Select the configuration you want to use.

Note: If you click **Automatic**, ModelCHECK automatically loads the configuration files based on the rules in the `condition.mcc` file.

To Manually Set Up the `setconf.mcc` File

1. In the `config_init.mc` file, set the `CNFG_SELECT_AUTO` configuration option to `N` or `A` to allow users to decide what configuration files to use. If this option is set to `Y`, the configuration files to use are chosen automatically.
 - o `N` - ModelCHECK requires you to choose the configuration files to run
 - o `A` - ModelCHECK prompts you to specify whether you want to load the configuration files or let ModelCHECK select them automatically.

2. Open the `setconf.mcc` file using a text editor. This file is located in `<proengineer-loadpoint>/modchk/text/<language>/config` or in the directory that you specify with the `$MCDIR` environment variable. Edit the file to set the **Load Config** configurations. For example:

```
PDM=(checks/pdm.mch) (start/pdm.mcs) (constant/pdm.mcn) (status/pdm.mcq)
```

```
Light=(checks/simple_checks.mch) (start/default_start.mcs)  
(constant/mm.mcn) (status/default_status.mcq)
```

```
NoStart=(checks/default_checks.mch) (start/nostart.mcs)  
(constant/mm.mcn) (status/default_status.mcq)
```

3. Save the `setconf.mcc` file. All the configuration files you list in this file must be in their respective directories.
4. Click **Analysis > ModelCHECK > Load Config** in Pro/ENGINEER. The **Load Config** menu appears. If the `setconf.mcc` file is set as in the previous example, the following configurations are listed in the **Load Config** menu: **Automatic, PDM, Light, NoStart**.
5. Select the configuration you want to use.

Note: If you click **Automatic**, ModelCHECK automatically loads the configuration files based on the rules in the `condition.mcc` file.

Customizing Load Config Menu in `msg_mc.txt`

Use the `msg_mc.txt` file to customize the configuration commands in the **Load Config** menu. The `msg_mc.txt` file in `<modelcheck-loadpoint>/text/<language>/config/text` is used to build the ModelCHECK **Load Config** menu commands when ModelCHECK initializes. You can edit the file using either a text editor or **Text Files** in the left pane of the **PTC ModelCHECK Configuration Tool** dialog box.

Note: Be careful when editing this file. If you edit the wrong lines, you may have to reinstall ModelCHECK.

The default command names are **Automatic**, **Heavy**, **Medium**, and **Light**. If you want to rename them, edit the file as shown below:

Note: You cannot customize the **Automatic** command.

Original msg_mc.txt

```
%CILabel1
```

```
Heavy Config
```

```
%CILabel2
```

```
Medium Config
```

```
%CILabel3
```

```
Light Config
```

New msg_mc.txt

```
%CILabel1
```

```
PDM Config
```

```
%CILabel2
```

```
Light Config
```

```
%CILabel3
```

```
NoStart Config
```

Then scroll down this file and edit the lines for the message window descriptions:

Original msg_mc.txt (message window descriptions)

```
%CIMessage1
```

```
Select Heavy Config from setconf.mcc.
```

```
%CIMessage2
```

```
Select Medium Config from setconf.mcc.
```

```
%CIMessage3
```

```
Select Light from setconf.mcc.
```

New msg_mc.txt (message window descriptions)

```
%CIMessage1
```

```
Select PDM Check-in Config from setconf.mcc.
```

```
%CIMessage2
```

```
Select Light from setconf.mcc.
```

```
%CIMessage3
```

```
Select NoStart from setconf.mcc.
```

Setting Up the Condition File: condition.mcc

About the condition.mcc File

The `condition.mcc` file is also referred to as a condition file. It specifies the conditions that determine the set of configuration files (start, check, constant, and status) to be read when you click **Automatically set config** under **Conditional settings** in the **PTC ModelCHECK Configuration Tool** dialog box. This file is read each time you run ModelCHECK.

You can also use the `condition.mcc` file to override specific checks.

To Set Up the condition.mcc File Using the PTC ModelCHECK Configuration Tool

1. Click adjacent to **Conditional settings** in the left pane of the **PTC ModelCHECK Configuration Tool** dialog box.
2. Click **Edit condition.mcc**. A table listing all the conditions appears in the right pane of the **PTC ModelCHECK Configuration Tool** dialog box. The check box for each condition allows you to specify whether ModelCHECK should evaluate the condition or treat it as a comment.
3. In the **Choose View** box, select **Conditions** to edit the SET CONFIG FILE section of the `condition.mcc` file.
4. Edit the conditions and the combination of configuration files for each condition using the boxes.
 - Click or clear the check box in the **COMMENT/UNCOMMENT** column. When you clear the check box, a ! mark is added at the beginning of the condition in the `condition.mcc` file. The ! mark indicates that the condition is a comment.

Note: The **PTC ModelCHECK Configuration Tool** dialog box only displays conditions with a ! mark in the `condition.mcc` file. Comments can also be indicated with a # mark if you manually edit the `condition.mcc` file. However, the **PTC ModelCHECK Configuration Tool** dialog box does not display conditions with a # mark.

- Add and delete rows to add and delete conditions, respectively.
 - Move rows up or down to order the conditions.
 - Add columns to specify multiple conditions (corresponding to the AND operator in the `config_init.mc` file) and more than one start, check, constant, and status configuration files.
 - Delete columns as required.
5. Specify the default combination of configuration files. If none of the conditions are true, ModelCHECK uses the default combination, corresponding to the ELSE statement in the `config_init.mc` file.

6. In the **Choose View** box, select **Override** to edit the OVERRIDE CHECKS section of the `condition.mcc` file.
7. Specify conditions to override checks, if any, using the boxes or fields as applicable.
8. Click or clear the check box in the **COMMENT/UNCOMMENT** column.
9. Click **Save**.

To Manually Set Up the condition.mcc File

1. Open the `condition.mcc` file using a text editor. This file is located in `<proengineer-loadpoint>/modchk/text/<language>/config` or in the directory specified with the `$MCDIR` environment variable.
2. Specify the conditions and the combination of configuration files for each condition.
3. Specify the conditions to override specific checks, if any.

Example: condition.mcc File

```
! Conditional file for ModelCHECK.

# SET CONFIG FILE

IF (USERNAME EQ finn) config=(check/check_default.mch)
(start/start_finn.mcs) (constant/constant_def.mcn) (status/status_1.mcq)

IF (USERNAME EQ gavin) AND (MODEL_UNIT EQ INCH)
config=(check/check_default.mch) (start/start_standard.mcs)
(start/start_gavin.mcs) (constant/constant_inch.mcn)
(status/status_2.mcq)

IF (USERNAME EQ gavin) AND (MODEL_UNIT EQ MM)
config=(check/check_default.mch) (start/start_default.mcs)
(start/start_gavin.mcs) (constant/constant_mm.mcn)
(status/status_generic.mcq)

IF (GROUPNAME EQ CHECKER) config=(check/checks_checker.mch)
(start/start_checker.mcs) (constant/constant_def.mcn)
(status/status_default.mcq)

IF (MODELNAME EQ ec*) config=(check/check_ec.mcs) (start/start_ec.mcs)
(constant/constant_def.mcn) (status/status_generic.mcq)

IF (MODEL_TYPE EQ PRT_SHEETMETAL) config=(check/check_shtmel.mch)
(start/start_shtmt1.mch) (constant/constant_inch.mcn)
(status/status_2.mcq)

IF (FT_GENERIC_PRT) AND (MODEL_UNIT EQ MM)
config=(check/check_generic.mch) (start/start_default.mch)
(constant/constant_mm.mcn) (status/status_1.mcq)
```

ModelCHECK - Help Topic Collection

```
IF (FT_INSTANCE_PRT) AND (MODEL_UNIT EQ INCH)
config=(check/check_instance.mch) (start/start_default.mch)
(constant/constant_inch.mcn) (status/status_2.mcq)

IF (MODEL_TYPE EQ PRT_PIPE) config=(check/check_pipe.mch)
(start/start_pipe.mcs) (constant/constant_def.mcn)
(status/status_generic.mcq)

IF (MODEL_TYPE EQ ASM_DESIGN) config=(check/simple_checks.mch)
(start/sample_start.mcs) (constant/inch.mcn) (status/sample_status.mcq)

IF (DATE_CREATED GTE 19970418) config=(check/check_default.mch)
(start/sample_start.mcs) (constant/constant_mm.mcn)
(status/status_default.mcq)

IF (PRO_VERSION GTE 199842) config=(check/check_default.mch)
(start/sample_start.mcs) (constant/constant_mm.mcn)
(status/status_generic.mcq)

IF (NOSTART) config=(check/simple_checks.mch) (start/nostart.mcs)
(constant/constant_inch.mcn) (status/status_2.mcq)

IF (MODEL_UNIT EQ INCH) config=(check/check_default.mch)
(start/default_start.mcs) (constant/constant_inch.mcn)
(status/status_1.mcq)

IF (MODEL_UNIT EQ MM) config=(check/check_default.mch)
(start/default_start.mcs) (constant/constant_mm.mcn)
(status/status_2.mcq)

ELSE config=(check/check_default.mch) (start/start_default.mcs)
(constant/constant_def.mcn) (status/status_default.mcq)

# OVERRIDE CHECKS
IF (NOCHECK) NOCHECK
IF (MODEL_SIZE EQ large) SHARP_EDGES = No
IF (MODEL_SIZE EQ large) SRF_EDGES = No
IF (MODEL_SIZE EQ large) SLA_INFO = No
IF (DRAWN_BY EQ John Wallace) MODEL_NAME = Error
```

About the SET CONFIG FILE Section of the condition.mcc File

The SET CONFIG FILE section is composed of a series of IF statements followed by an ELSE statement. When ModelCHECK runs, it reads this list until one of the equalities is met. If they all fail, the ELSE statement is read and applied.

The first section, SET CONFIG FILE, is where the combination of configuration files is set depending on the first condition in the list of IF statements that is met.

ModelCHECK evaluates each IF statement and sets the configuration files to the first instance that is true.

The operators that can be used for comparison are:

- EQ - equal to

- NEQ - not equal to
- GT - greater than
- LT - less than
- GTE - greater than or equal to
- LTE - less than or equal to

Each IF statement can have one or more equalities. If there are several equalities, they are separated by AND statements. Following the equality statements on each line is the list of files that are read to form a configuration.

Items You Can Use in Equality Statements

The items you can use in the equality statements follow.

Item	Name
User currently logged in	USERNAME
User's group	GROUPNAME
Name of the current model	MODELNAME
If the model is a generic of a family table	FT_GENERIC_PRT and FT_GENERIC_ASM
If the model is an instance of a family table	FT_INSTANCE_PRT and FT_INSTANCE_ASM
Model units	MODEL_UNIT
Version of Pro/ENGINEER	PRO_VERSION
Date created	DATE_CREATED
Model type	MODEL_TYPE
Parameter	See Below

In the case of USERNAME, GROUPNAME, MODELNAME, and PARAMETER, variables can be specified using the following metacharacters:

- * - Any number of characters
- ? - One character
- # - One numerical character
- \$ - One string character

Examples of valid values include (USERNAME EQ p*), (MODELNAME EQ 132.321.*), (PARAMETER EQ ??AC).

MODEL_TYPE allows you to specify a combination of configuration files based on different part types. The part types are:

- PRT_SOLID
- PRT_SHEETMETAL
- PRT_SKELETON
- PRT_PIPE
- PRT_HARNESS
- ASM_DESIGN
- ASM_INTERCHANGE
- ASM_MOLD_LAYOUT

Note: If you have more than one condition for part types, the first condition that is satisfied is applied. Models can satisfy more than one condition (for example, a pipe is also a solid), which makes the order of conditions in the `condition.mcc` file very important.

About Groups

Users can be assigned to groups, and specific configuration files can be loaded for users depending on the group they belong to. In the `condition.mcc` file, groups are specified using the syntax:

```
IF (GROUPNAME EQ name_of_group) config=
```

Groups are listed in text files having the `.mcg` extension.

To Set Up the Group Files Using the PTC ModelCHECK Configuration Tool

1. Click  adjacent to **Group Files** in the left pane of the **PTC ModelCHECK Configuration Tool** dialog box.
2. Select the required group file. A table listing the contents of the file appears in the right pane of the **PTC ModelCHECK Configuration Tool** dialog box.

Note: Click **Create new file** to create a new group file.

3. Edit the contents using the boxes. You can add and delete rows as required.
4. Click **Save** or **Save as** to save your changes to the current or a different file, respectively.

To Manually Set Up the Group Files

1. Open the file using a text editor. By default, group files are located in `<proe>/modchk/text/<language>/config/groups`.
2. To create a group called `checkers`, create a file named `checkers.mcg` in the `groups` directory. List each member in this file by the login name, a single name in a row.

Configuring for Pro/ENGINEER Releases

The `condition.mcc` file can be configured to use different configuration files based on the version of Pro/ENGINEER in which the model was last saved. In the `condition.mcc` file, versions of Pro/ENGINEER are specified using the syntax:

```
IF (PRO_VERSION LTE 1999120) config=...
```

Datecodes are specified using the current Pro/ENGINEER build string as in the notation `YYYYWW0` where `YYYY` denotes the year, `WW` the week, and `0` the first build of the week.

Note: The date must be an actual Pro/ENGINEER datecode. For example, click **Help > About Pro/ENGINEER** to see the datecode (manufacturing code) for your current session.

Configuring for Model Creation Dates

The `condition.mcc` file can be configured to use different configuration files based on the date when the model was created. In the `condition.mcc` file, the creation date is specified using the syntax:

```
IF (DATE_CREATED GTE 19991231) config=...
```

Date codes are specified using the notation `YYYYMMDD` where `YYYY` denotes the year, `MM` the month, and `DD` the date.

Combining Several Start Files

You can combine several start files into a single configuration. This allows you to have a standard list of start part items that are in all models while giving departments the opportunity to have a set of their own start part items in addition to the company standard ones.

If there is duplicate information in the start files, the configuration file listed last is used. Consider the sample `condition.mcc` file where the `start_standard.mcs` and `start_gavin.mcs` files are listed on the same line. If the `start_standard` file contains the line:

```
PRT_PARAMETER WIDGET STR EQ GREEN
```

and if the `start_gavin` file contains the following line:

```
PRT_PARAMETER WIDGET STR EQ BLUE
```

then the line from the `start_standard` file is ignored. That line conflicts with the line from the `start_gavin` file and the line from the `start_standard` file comes before the line from the `start_gavin` file.

Example: SET CONFIG FILE Sample Lines Explained

The lines in the SET CONFIG FILE section of the sample `condition.mcc` file are explained as follows:

- `IF (USERNAME EQ finn) config=(check_default.mch) (start_finn.mcs) (constant_def.mcn) (status_1.mcq)`

Runs the listed configuration files if the user's login name is `finn`.

- `IF (USERNAME EQ gavin) AND (MODEL_UNIT EQ INCH) config=(check_default.mch) (start_standard.mcs) (start_gavin.mcs) (constant_inch.mcn) (status_2.mcq)`

Runs the listed configuration files if the user's login name is `gavin` and the model units are set to inches.

- `IF (USERNAME EQ gavin) AND (MODEL_UNIT EQ MM) config=(check_default.mch) (start_gavin.mcs) (constant_mm.mcn) (status_generic.mcq)`

Runs the listed configuration files if the user's login name is `gavin` and the model units are set to metric.

- `IF (GROUPNAME EQ CHECKER) config=(checks_checker.mch) (start_checker.mcs) (constant_def.mcn) (status_default.mcq)`

Runs the listed configuration files if the user belongs to the `CHECKER` group.

- `IF (MODELNAME EQ ec*) config=(check_ec.mcs) (start_ec.mcs) (constant_def.mcn) (status_generic.mcq)`

Runs the listed configuration files if the name of the model starts with `ec`.

- `IF (MODEL_TYPE EQ PRT_SHEETMETAL) config=(check_shtm1.mch) (start_shtmt1.mch) (constant_inch.mcn) (status_2.mcq)`

Runs the listed configuration files if the model is a sheet metal part.

- `IF (FT_GENERIC_PRT) AND (MODEL_UNIT EQ MM) config=(check_generic.mch) (start_default.mch) (constant_mm.mcn) (status_1.mcq)`

Runs the listed configuration files if the model is a generic part and its units are `mm`.

- `IF (FT_INSTANCE_PRT) AND (MODEL_UNIT EQ INCH) config=(check_instance.mch) (start_default.mch) (constant_inch.mcn) (status_2.mcq)`

Runs the listed configuration files if the model is an instance of a family table and the model units are metric.

- IF (MODEL_TYPE EQ PRT_PIPE) config=(check_pipe.mch) (start_pipe.mcs)
(constant_def.mcn) (status_generic.mcq)

Runs the listed configuration files if the model is a pipe.

- IF (DATE_CREATED GTE 19970418) config=(check_default.mch)
(sample_start.mcs) (constant_mm.mcn) (status_default.mcq)

Runs the listed configuration files if the model has been created after the specified date.

- IF (PRO_VERSION GTE 199842) config=(check_default.mch)
(sample_start.mcs) (constant_mm.mcn) (status_generic.mcq)

Runs the listed configuration files if the model has been last saved in a Pro/ENGINEER version, later than the specified version.

- IF (NOSTART) config=(simple_checks.mch) (nostart.mcs)
(constant_inch.mcn) (status_2.mcq)

Runs the listed configuration files if a parameter called NOSTART is found in the model.

- IF (MODEL_UNIT EQ INCH) config=(check_default.mch)
(default_start.mcs) (constant_inch.mcn) (status_1.mcq)

Runs the listed configuration files if the units of the model are inches.

- IF (MODEL_UNIT EQ MM) config=(check_default.mch) (default_start.mcs)
(constant_mm.mcn) (status_2.mcq)

Runs the listed configuration files if the units of the model are inches.

- ELSE config=(check_default.mch) (start_default.mcs)
(constant_def.mcn) (status_default.mcq)

Runs the default configuration files if none of the above conditions are true.

About the OVERRIDE CHECKS Section of the condition.mcc File

In the OVERRIDE CHECKS section of the `condition.mcc` file, specific checks can be overridden under certain conditions. This section contains a series of IF statements. When ModelCHECK runs, it reads this list from the file and applies all the statements that are correct.

Example: OVERRIDE CHECKS Sample Lines Explained

Lines in the OVERRIDE CHECKS section of the sample `condition.mcc` are explained as follows:

- IF (NOCHECK) NOCHECK

Instructs ModelCHECK to look for the existence of a parameter called `NOCHECK`. If it is found in the model, ModelCHECK skips checking the model. Some more examples to configure ModelCHECK for not checking the model are:

- `IF (SPECIFIC) NOCHECK`
If the model contains a parameter named `SPECIFIC`, skip checking the model.
- `IF (SPECIFIC EQ PTC) NOCHECK`
If the model contains a parameter named `SPECIFIC` with a value of `PTC`, skip checking the model.
- `IF (MODELNAME EQ 123*) NOCHECK`
If the model name begins with `123`, skip checking the model.
- `IF (MODEL_UNIT NEQ MM) AND (MODEL_UNIT NEQ INCH) NOCHECK`
If the model units are neither millimeters nor inches, skip checking the model.
- `IF (MODEL_SIZE EQ LARGE) SHARP_EDGES = No`
Instructs ModelCHECK to look for a parameter called `MODEL_SIZE` and determine if it has a value of `LARGE` or not. If it does, ModelCHECK does not run the sharp-edge check on this model.
- `IF (DRAWN_BY EQ John Wallace) MODEL_NAME = Error`
Instructs ModelCHECK to look for a parameter called `DRAWN_BY` and determine whether it has a value of `John Wallace` or not. If it does, ModelCHECK sets the `MODEL_NAME` check to report an error if it fails (overriding whatever is in the check configuration file).

Note: Parameter names and values are case sensitive. If you want ModelCHECK to accept both uppercase and lowercase versions of a parameter, specify them on two separate lines.

Setting Up the Check Configuration File

About the Check Configuration File

The check configuration file, or check file, has the `.mch` extension. ModelCHECK uses this file to determine when to run checks and how to report any problems. The condition file determines which check file to use each time you run ModelCHECK.

To Set Up the Check Configuration File Using the PTC ModelCHECK Configuration Tool

1. Click adjacent to **Configuration settings** in the left pane of the **PTC ModelCHECK Configuration Tool** dialog box.
2. Click adjacent to **Check files**.
3. Select the required check file. A table listing the checks and their values appears in the right pane of the **PTC ModelCHECK Configuration Tool** dialog box.

Note: Click **Create new file** to create a new check configuration file. ModelCHECK dynamically updates all boxes listing check configuration files in the **PTC ModelCHECK Configuration Tool** dialog box with the name of the new file.

4. Click **Delete** if you want to delete the file.
5. In the **Check type to view** box, select the type of check. All checks of the selected type are listed in the table. ModelCHECK dynamically updates the boxes in the table to only list checks of the selected type.
6. Edit the checks and their values using the boxes.
You can add and delete rows to add and delete checks, respectively.
7. Click **Save** or **Save as** to save your changes to the current or a different file, respectively.

To Manually Set Up the Check Configuration File

1. Open the <filename>.mch file using a text editor. By default, this file is located in <proengineer-loadpoint>/modchk/text/<language>/config/check.
2. Set a value for the Interactive (I), Batch (B), Regenerate (R), and Save (S) modes for each check. The values for each check are:
 - N - Does not perform the check.
 - Y - Performs the check and lists the results but does not report any problems in the ModelCHECK report. Use Y for minor problems or for information-only checks.
 - E - Performs the check and reports an error if it fails. Errors are reported in the ModelCHECK report. When errors are found, a model parameter is created that has a value of the number of errors found in the model. A PDM system can be set to track models with errors or to even reject their submission. Use E for the most serious problems.
 - W - Does the same as E, except no model parameter is created. Use W for less serious problems.

Note: If you see a check that does not apply to your site, turn the check off by setting it to N in all modes.

3. Save the edited file with the .mch extension.

Part Mode Checks

Applicable checks and their possible values in Part mode follow. Click the check name to see the check definition and suggested settings.

- ACCURACY_INFO (Accuracy Information)
Y/N/E/W
- ADD_CHK_PARAM (Add a Parameter)
Y/N
- AE_GTOL_DUPLICATE (Duplicate Geometric Tolerance Annotation Elements)
Y/N/E/W
- AE_MISSINGREFS (Annotation Elements with Missing References)
Y/N/E/W
- AE_SF_DUPLICATE (Duplicate Surface Finish Annotation Elements)
Y/N/E/W
- AF_INCOMPLETE (Incomplete Annotation Features)
Y/N/E/W
- ANNTN_INACTIVE (Inactive Annotations)
Y/N/E/W
- BURIED_FEAT (Buried Features)
Y/N/E/W
- CHAMFER_CHILD (Children of Chamfers)
Y/N/E/W
- CHILDREN_EXIST (Standard Children)
Y/N/E/W
- 4. COSMETIC_FEAT (Cosmetic Features)
Y/N
- CYL_CUT_SLOTS (Cuts and Slots That Should Be Holes)
Y/N/E/W
- CYL_DIAMS (Circular Cut Diameters)
Y/N/E/W

- DATUM_RENAME (Renaming Datums)
Y/N/E/W
- DEF_DENSITY (Model Density)
Y/N/E/W
- DEFAULT_CHILD (Children of the Default Datum Planes)
Y/N
- DEPENDENT_FEATURE (Dependent Features)
Y/N/E/W
- DESIGNATED_ATTR (Designated Attributes)
Y/N/E/W
- DRAFT_ANGLES (Standard Draft Angles)
Y/N/E/W
- DRAFT_CHILD (Children of Draft)
Y/N/E/W
- DTM_AXES_INFO (Datum Axis Information)
Y/N
- DTM_CSYS_INFO (Coordinate System Information)
Y/N
- DTM_CURVE_INFO (Datum Curve Information)
Y/N
- DTM_PLANE_INFO (Datum Plane Information)
Y/N
- DTM_POINT_INFO (Datum Point Information)
Y/N
- DUPLICATE_MODELS (Duplicate Models)
Y/N/E/W
- EARLY_CHAMFER (Early Chamfers)
Y/N/E/W
- EARLY_COSMETIC (Early Cosmetic Features)
Y/N/E/W

ModelCHECK - Help Topic Collection

- EARLY_DRAFT (Early Draft)
Y/N/E/W
- EARLY_ROUND (Early Rounds)
Y/N/E/W
- EDGE_REFERENCES (Features That Reference Edges)
Y/N/E/W
- EXTERNAL_DEPS (External Dependencies)
Y/N/E/W
- EXTRA_LAYERS (Layer Status)
Y/N/E/W
- EXTRA_PARAMS (Parameter Format Errors)
Y/N/E/W
- FAMILY_INFO (Family Table Information)
Y/N/E/W
- FEATURE_INFO (Feature Information)
Y/N
- FILE_SIZE (File Size)
Y/N
- FREEFORM (Freeform Surfaces)
Y/N/E/W
- FT_DEF_VALS (Family Table Default Values)
Y/N/E/W
- FT_STD_PARAMS (Family Table Standard Parameters)
Y/N/E/W
- GEOM_CHECKS (Geometry Checks)
Y/N/E/W
- GEOMETRIC_TOL (Geometric Tolerances)
Y/N
- HOLE_DIAMS (Standard Hole Diameters)
Y/N/E/W

- IGNORE_FEAT (Problem Features That Should Be Ignored)
Y/N
- IMPORT_FEAT (Imported Features)
Y/N/E/W
- INCOMPLETE_FEAT (Incomplete Features)
Y/N/E/W
- INSERT_MODE (Insert Mode Left Active)
Y/N/E/W
- INSTANCE_NAME (Instance Name)
Y/N/E/W
- LAYER_DISPSTAT (Layers That Are Set to Display)
Y/N/E/W
- LAYER_DTM_BLANK (Datum Features on Blanked Layers)
Y/N/E/W
- LAYER_EXT_ITEMS (Extra Features on Layers)
Y/N/E/W
- LAYER_INFO (Layer Information)
Y/N
- LAYER_ITEMS (Items on Multiple Layers)
Y/N/E/W
- LAYER_MOVE (Move Items from Old Layers to New Ones and Delete the Old One)
Y/N/E/W
- LAYER_PLACE (Layers Contain Standard Items)
Y/N/E/W
- LAYER_STATUS (Layer Status)
Y/N/E/W
- LAYOUT_INFO (Layout Information)
Y/N/E/W
- LOW_TOLERANCE (Lowest Allowable Tolerance)
Y/N/E/W

ModelCHECK - Help Topic Collection

- MATERIAL_INFO (Material Type)
Y/N/E/W
- MEMORY_SPACE (Memory Space Used)
Y/N
- MERGE_FEAT (Merged Features)
Y/N/E/W
- MINMAXTOL_INFO (Minimum and Maximum Tolerances)
Y/N
- MODEL_NAME (Model Name Specification Errors)
Y/N/E/W
- MODEL_NAME_STR (Model Name)
Y/N
- NAMED_FEAT (Named Features)
Y/N
- OVERALL_SIZE (Overall Size)
Y/N
- PARAMCHECK (Parameter Format Errors)
Y/N/E/W
- PARAM_INFO (Model Parameters)
Y/N
- PARAM_NOTE_REQ (Required Parameter Notes)
PARAM_NOTE_UNACC (Unacceptable Parameter Notes)
Y/N/E/W
- PARAM_RENAME (Parameter Rename)
Y/N/E/W
- PARAM_SPELL (Parameter Spelling)
Y/N/E/W
- PARAM_UNUSED (Unused Parameters)
Y/N/E/W
- PLANE_CHILD (Datum Planes without Children)
Y/N/E/W

- PLANE_PARENT (Datum Planes That Only Have One Parent)
Y/N/E/W
- PRO_VERSION (Version of Pro/ENGINEER)
Y/N/E/W
- RC_INCOMPLETED (RuleCHECK Rules That Are Not Complete)
Y/N/E/W
- REG_FEATURES (Resumed Features)
Y/N
- REGEN_ERRS (Regeneration Errors)
REGEN_WRNS (Regeneration Warnings)
Y/N/E/W
- RELATION_COMM (Comments in Relations)
Y/N/E/W
- RELATION_ERRS (Relation Errors)
Y/N/E/W
- RELATION_INFO (Relation Information)
Y/N/E/W
- RELATION_MISS (Relations That Are Missing)
Y/N/E/W
- RELATION_MULT (Relations That Have Multiple Assignments)
Y/N/E/W
- RELATION_UPDATE (Relations That Need Update)
Y/N/E/W
- RENAMED_SYMBOLS (Renamed Dimension Symbols)
Y/N
- REPT_LAYR_ALWAYS (Report Missing Layers)
Y/N
- ROUND_CHILD (Children of Rounds)
Y/N/E/W
- RULECHECK_INFO (RuleCHECK Information)
Y/N/E/W

ModelCHECK - Help Topic Collection

- SEARCH_DUP_MODELS (Search for Duplicate Models)
Y/N/E/W
- SHARP_EDGES (Sharp Edges)
Y/N/E/W
- SHORT_EDGES (Short Edges)
Y/N/E/W
- SHTMTL_BENDTAB (Sheet Metal Bend Tables)
Y/N/E/W
- SHTMTL_FLAT (Sheet Metal Flat Patterns or Flat States)
Y/N/E/W
- SHTMTL_THICK (Standard Sheet Metal Wall Thicknesses)
Y/N/E/W
- SHTMTL_UNBENDS (Sheet Metal Unbends)
Y/N/E/W
- SHTMTL_YFACTOR (Sheet Metal Y-Factor)
Y/N
- SIMPREP_INFO (Simplified Representations)
Y/N
- SIMPREP_NAME (Simplified Representation Names)
Y/N/E/W
- SKETCH_ITEMS (Number of Entities in a Sketched Feature)
Y/N/E/W
- SLA_INFO (SLA Information)
Y/N/E/W
- SMALL_CYLSRF (Small Cylindrical Surfaces)
Y/N/E/W
- SRF_EDGES (Surface Gaps and Overlaps)
Y/N/E/W
- STARTCHECK (Start Part and Start Assembly Check)
Y/N/E/W

- **STD_NOTES_MISSING (Missing Standard Notes)**
Y/N/E/W
- **SUP_FEATURES (Suppressed Features)**
Y/N/E/W
- **UDF_INFO (UDF Information)**
Y/N
- **UNITS_LENGTH (Length Units)**
Y/N/E/W
- **UNITS_MASS (Mass Units)**
Y/N/E/W
- **VIEW_INFO (View Information)**
Y/N
- **XSEC_INFO (Cross Section Information)**
Y/N

Assembly Mode Checks

Applicable checks and their possible values in Assembly mode follow. Click the check name to see the check definition and suggested settings.

- **AE_GTOL_DUPLICATE (Duplicate Geometric Tolerance Annotation Elements)**
Y/N/E/W
- **AE_SF_DUPLICATE (Duplicate Surface Finish Annotation Elements)**
Y/N/E/W
- **AF_INCOMPLETE (Incomplete Annotation Features)**
Y/N/E/W
- **ANNTN_INACTIVE (Inactive Annotations)**
Y/N/E/W
- **ASM_BOM (Assembly Bill of Materials)**
Y/N
- **ASM_FEATURES (Assembly Features)**
Y/N
- **BULK_ITEMS (Bulk Items)**
Y/N/E/W

ModelCHECK - Help Topic Collection

- CIRCULAR_REFS (Circular References)
Y/N/E/W
- EXTERNAL_DEPS (External Dependencies)
Y/N/E/W
- FRZ_COMPONENTS (Frozen Components)
Y/N/E/W
- GEN_COMPONENTS (Generic Components)
Y/N/E/W
- GLOBAL_INTF (Assembly Global Interference)
Y/N/E/W
- MIS_COMPONENTS (Missing Components)
Y/N/E/W
- NUM_COMPONENTS (Number of Components)
Y/N
- PACK_COMPONENTS (Packaged Components)
Y/N/E/W
- SUP_COMPONENTS (Suppressed Components)
Y/N/E/W
- UNQ_COMPONENTS (Unique Components)
Y/N

Drawing Mode Checks

Applicable checks and their possible values in Drawing mode follow. Click the check name to see the check definition and suggested settings.

- BOUND_INFO (Boundary Information)
Y/N/E/W
- DEFAULT_VIEWS (Views with the Default Hidden Line Display Mode)
Y/N/E/W
- DIM_OVERWRITE (Overwritten Dimensions)
Y/N/E/W
- DRAFT_GEOM (Draft Geometry not Associated to a View)
Y/N/E/W

- DRAWING_LAYERS (Drawing Layers)
Y/N/E/W
- DRAWING_NAME (Drawing Name)
Y/N/E/W
- DRAWING_PARAMS (Parameter Checks)
Y/N/E/W
- ERASED_VIEWS (Erased Views)
Y/N/E/W
- FORMAT_NAME (Drawing Format Name)
Y/N/E/W
- IGNORE_SHEETS (Sheets to Be Ignored)
Y/N/E/W
- MODELS_USED (Models Used in a Drawing)
Y/N
- NOTE_CASE (Note Case)
Y/N/E/W
- NOTE_FONT (Note Fonts)
Y/N/E/W
- NOTE_HEIGHT (Note Height)
Y/N/E/W
- NOTE_INFO (Drawing Note Information)
Y/N
- NOTE_SPELL (Note Spelling Errors)
Y/N/E/W
- NOTE_UNACCEPT (Unacceptable Notes)
Y/N/E/W
- NUM_DRAW_SHEETS (Maximum Number of Drawing Sheets)
Y/N/E/W
- OVERLAP_INFO (Overlap Information)
Y/N/E/W

ModelCHECK - Help Topic Collection

- PARAMS_EXIST (Drawing Parameters)
Y/N/E/W
- PARAMS_USED (Drawing Parameters Used)
Y/N/E/W
- REGEN_DIMS (Dimensions That Cannot Regenerate)
Y/N/E/W
- SHEET_SIZE_INFO (Sheet Size Information)
Y/N/E/W
- STD_DTL_SETUP (Drawing Detail File)
Y/N/E/W
- SYMBOL_INFO (Symbol Information)
Y/N
- SYMBOL_SPELL (Spelling Mistakes in Symbols)
Y/N/E/W
- TABLE_CELLS (Table Cells)
Y/N/E/W
- TITLE_INFO (Title Block Information)
Y/N/E/W
- TITLE_SPELL (Title Block Spelling Errors)
Y/N/E/W
- UNUSED_MODELS (Unused Models in Drawings)
Y/N/E/W
- UNUSED_SHEETS (Empty Sheets)
Y/N/E/W
- VIEW_SCALE (Scale Assigned to Views)
Y/N/E/W

GeomIntegrityCHECK Checks

You can run GeomIntegrityCHECK in all ModelCHECK operating modes using the MC_VDA_RUN configuration option in the `config_init.mc` file. Applicable GeomIntegrityCHECK checks and their possible values in Part, Assembly, or Drawing modes follow. Click the check name to see the check definition and suggested

settings. See the GeomIntegrityCHECK topics for details about the GeomIntegrityCHECK checks.

- M1_TINY_ELMNT (Tiny Elements)
Y/N/E/W
- M2_IDENTICAL_ELMNT (Identical Elements)
Y/N/E/W
- M3A_POSITION_CONT (Position Continuity)
Y/N/E/W
- M3B_TANG_CONT (Tangential Continuity)
Y/N/E/W
- M3C_CURV_CONT (Curvature Continuity)
Y/N/E/W
- M4_POLYN_DEG (Polynomial Degree)
Y/N/E/W
- M5_WAVINESS (Waviness)
Y/N/E/W
- M6_KNOT_DIST (Knot Distance)
Y/N/E/W
- C7_SELF_DIST (Distance from Itself)
Y/N/E/W
- D28_IGES_TEXT (IGES Conform Text)
Y/N/E/W
- SU8_TINY_SEG_EDGE (Tiny Segment Edge)
Y/N/E/W
- SU9_TINY_CURV_RAD (Minimum Curvature Radius)
Y/N/E/W
- SU10_BOUND_ANGLE (Angle between Edge Curves)
Y/N/E/W
- SU11_NORM_REVERSAL (Reversal of Normals)
Y/N/E/W

ModelCHECK - Help Topic Collection

- SU12_PATCH_DIST (Patch Distribution)
Y/N/E/W
- SU13_UNOC_PATCH_ROW (Unoccupied Patch Rows)
Y/N/E/W
- F14_BOUND_DIST (Penetration or Distance of Boundaries)
Y/N/E/W
- F15_SURF_DIST (Proximity of a Boundary Curve to Its Surface)
Y/N/E/W
- F16_SIM_ORIENT (Parallel Path or Similar Orientation)
Y/N/E/W
- F17_NUM_SEG (Number of Segments in a Boundary Curve)
Y/N/E/W
- T18_NUM_FACE (Junction or Number of Faces Per Edge)
Y/N/E/W
- T19_NORMAL_ORIENT (Orientation of Similar Normals)
Y/N/E/W
- T20_KNIFE_EDGES (Knife Edge)
Y/N/E/W
- SO21_DIST_VERT_EDGE (Distance to Vertex Edge)
Y/N/E/W
- SO22_DIST_VERT_FACE (Distance to Vertex Face)
Y/N/E/W
- SO23_HIST_DELETE (Deletion of History)
Y/N/E/W
- SO24_EXTRA_GEOM (Auxiliary Geometry)
Y/N/E/W
- SO25_CAVITIES (Cavities)
Y/N/E/W
- SO26_MULT_BODY (Multi-Body Solids)
Y/N/E/W

- SO27_MULT_SOLID (Multi-Solid Parts)

Y/N/E/W

ModelUPDATE Checks

You can run ModelUPDATE in the ModelCHECK Interactive mode using the MU_ENABLED configuration option in the config_init.mc file. Applicable checks and their possible values in ModelUPDATE mode follow. Click the check name to see the check definition and suggested settings.

- ACCURACY_INFO (Accuracy Information)

Y/N/E/W

- BURIED_FEAT (Buried Features)

Y/N/E/W

- CREATE_VIEW (Create Views)

Y/N

- DRAWING_LAYERS (Drawing Layers)

Y/N/E/W

- ERASED_VIEWS (Erased Views)

Y/N/E/W

- EXTRA_LAYERS (Extra Layers)

Y/N/E/W

- EXTRA_PARAMS (Extra Parameters)

Y/N/E/W

- INSERT_MODE (Insert Mode Left Active)

Y/N/E/W

- LAYER_MOVE (Move Items from Old Layers to New Ones and Delete the Old One)

Y/N/E/W

- LAYER_PLACE (Layers Contain Standard Items)

Y/N/E/W

- LAYER_STATUS (Layer Status)

Y/N/E/W

- LAYER_UNWANTED (Non-Standard Layers)

Y/N

ModelCHECK - Help Topic Collection

- MATERIAL_INFO (Material Type)
Y/N/E/W
- PARAMCHECK (Parameter Format Errors)
Y/N/E/W
- PARAM_MAP (Parameter Mapping)
Y/N
- PARAM_UNUSED (Unused Parameters)
Y/N/E/W
- PARAM_UNWANTED (Non-Standard Parameters)
Y/N
- REL_UNWANTED (Unwanted Relations)
Y/N
- RELATION_MISS (Relations That Are Missing)
Y/N/E/W
- RELATION_UPDATE (Relations That Need Update)
Y/N/E/W
- STARTLAYR (Missing Layers)
- STARTPARM (Missing Parameters)
- UNUSED_MODELS (Unused Models in Drawings)
Y/N/E/W
- UNUSED_SHEETS (Empty Sheets)
Y/N/E/W

Storing Metrics for Checks

ModelCHECK's check configuration files have a fifth column (M) reserved for metrics. A few sample lines are printed below:

# PART REPORT CONFIGURATION						
STARTCHECK	YNEW	E	E	W	W	Y
PARAMCHECK	YNEW	E	E	W	W	Y
PARAM_SPELL	YNEW	E	E	W	W	N

The entry in the metrics column (Y or N) determines whether ModelCHECK stores metrics for the given check when it runs.

1. Set the `MC_METRICS` configuration option in the `config_init.mc` file to turn metrics checking on.
2. Set the `DIR_METRICS` configuration option in the `config_init.mc` file to specify the directory to store the metrics files. While running, the metrics program writes temporary files to the directory specified by the `DIR_REPORTS` configuration option. The metrics program then moves the files to the location specified by the `DIR_METRICS` configuration option when you exit Pro/ENGINEER.

Note: To make it easier to compile and manage data, it is recommended that the directory specified by the `DIR_METRICS` configuration option be set to a central location. All users need read and write access to this directory.

The directory specified by the `DIR_REPORTS` configuration option should be set to a local directory on each user's machine. This directory is written too often. If it is a network directory, ModelCHECK slows down.



Setting Up the Start Configuration File

About the Start Configuration File

The start configuration file, or start file, stores the initialization information for parts. ModelCHECK uses the information while checking models. The start configuration file has the `.mcs` extension. In the start configuration file, you can initialize Part mode options, Assembly mode options, Drawing mode options, and external files.

You can have several start configuration files and use more than one at a time. The condition file determines which start file to use each time you run ModelCHECK.

To Set Up the Start Configuration File Using the PTC ModelCHECK Configuration Tool

1. Click  adjacent to **Configuration settings** in the left pane of the **PTC ModelCHECK Configuration Tool** dialog box.
2. Click  adjacent to **Start files**.
3. Select the required start file. A table listing the start file configuration options and their values appears in the right pane of the **PTC ModelCHECK Configuration Tool** dialog box.

Note: Click **Create new file** to create a new start configuration file. ModelCHECK dynamically updates all boxes listing start configuration files in the **PTC ModelCHECK Configuration Tool** dialog box with the name of the new file.

4. In the **Choose items to view** box, select the category. All configuration options of the selected category are listed in the table. The list of categories also includes the external files used.
5. Select an option to see and edit its definition in the lower table.

6. Edit the configuration options and their definitions using the boxes. Succeeding items in the definition automatically change according to the current setting.
 - To change a configuration option, change the definition, and click **Add Item**.
 - To add a configuration option, click **Add row**, add the definition, and click **Add item**.
 - Remove items to delete configuration options.
 - Move items up or down as required.
7. Click **Save** or **Save as** to save your changes to the current or a different file, respectively.

To Manually Set Up the Start Configuration File

1. Open the <filename>.mcs file using a text editor. By default, this file is located in <proengineer-loadpoint>/modchk/text/<language>/config/start.
2. List parameters to add to the model.
3. Save the file with the .mcs extension.

You can have several start configuration files and use more than one at a time.

Start File Configuration Options Summary

Part and Assembly Mode

Feature	Part Mode	Assembly Mode
Check Parameter	PRT_ADD_CHK_PARAM	ASM_ADD_CHK_PARAM
Datum Axes	PRT_DATUM_AXIS	ASM_DATUM_AXIS
Datum Csys	PRT_DATUM_CSYS	ASM_DATUM_CSYS
Datum Curves	PRT_DATUM_CURVE	ASM_DATUM_CURVE
Datum Planes	PRT_DATUM_PLANE	ASM_DATUM_PLANE
Datum Points	PRT_DATUM_POINT	ASM_DATUM_POINT
Family Table Parameter	PRT_FT_PARAMETER	ASM_FT_PARAMETER
Layer Move	PRT_LAYER_MOVE	ASM_LAYER_MOVE
Layers	PRT_LAYER	ASM_LAYER

Feature	Part Mode	Assembly Mode
Length Units	PRT_UNITS_LENGTH	ASM_UNITS_LENGTH
Mass Units	PRT_UNITS_MASS	ASM_UNITS_MASS
Material Name	MATERIAL_NAME	
Model Name	PRT_MODEL_NAME PRT_INSTANCE_NAME	ASM_MODEL_NAME ASM_INSTANCE_NAME
Parameter Rename	PRT_PARAM_RENAME	ASM_PARAM_RENAME
Parameters	PRT_PARAMETER	ASM_PARAMETER
Pro/ENGINEER Version	PRT_PRO_VERSION	ASM_PRO_VERSION
Relation	PRT_RELATION	ASM_RELATION
Relation Comment	PRT_COMMENT	ASM_COMMENT
Standard Model Notes	PRT_STD_NOTE	ASM_STD_NOTE
Required and Unacceptable Note Parameter	PRT_PARAM_NOTE_REQ PRT_PARAM_NOTE_UNACC	ASM_PARAM_NOTE_REQ ASM_PARAM_NOTE_UNACC
Sheet Metal Bend Table	SHTMTL_BTNAME	
Tolerance Type	PRT_TOL_TYPE	ASM_TOL_TYPE
Views	PRT_VIEW	ASM_VIEW
Name of Simplified Representation	PRT_SIMPREP_NAME	ASM_SIMPREP_NAME
Unwanted Layers for ModelUPDATE	PRT_LAYER_UNWANTED	ASM_LAYER_UNWANTED
Parameter Mapping for ModelUPDATE	PRT_PARAM_MAP	ASM_PARAM_MAP

Feature	Part Mode	Assembly Mode
Unwanted Parameters for ModelUPDATE	PRT_PARAM_UNWANTED	ASM_PARAM_UNWANTED
Unwanted Relations for ModelUPDATE	PRT_REL_UNWANTED	ASM_REL_UNWANTED
Update Model Accuracy in ModelUPDATE	MU_ACCURACY	
Create Views for ModelUPDATE	PRT_CREATE_VIEW	

Drawing Mode

Format	DRW_FORMAT
Layer	DRW_LAYER
Layer Move	DRW_LAYER_MOVE
Model Name	DRW_MODEL_NAME
Note Font	DRW_NOTE_FONT
Note Height	DRW_NOTE_HEIGHT
Pro/ENGINEER Version	DRW_PRO_VERSION
Sheets to be Ignored	DRW_IGNORE_SHEETS
Symbol	DRW_SYMBOL
Table Cells	DRW_TABLE_CELLS
Unwanted Layers for ModelUPDATE	DRW_LAYER_UNWANTED
Parameter Mapping for ModelUPDATE	DRW_PARAM_MAP
Unwanted Parameters for ModelUPDATE	DRW_PARAM_UNWANTED
Unacceptable Note	DRW_NOTE_UNACC

External Files

Custom Checks	CUSTOM_CHECKS_FILE CUSTMTK_CHECKS_FILE
Draft Angle	STD_DRAFT_ANGLE_FILE
Drawing Detail	STD_DRW_DTL_FILE
Drawing Information	STD_DRW_INFO_FILE
External Lists	STD_USER_LIST_FILE
Hole and Cut Diameters	STD_HOLE_DIAM_FILE
Regeneration Messages	MC_REGEN_CONFIG_FILE
Relation Update	RELATION_UPDATE_FILE
Sheet Metal Thickness	STD_SHTMTL_THICK_FILE

Part and Assembly Mode Configuration Options for the Start File

Configuration options available in the start configuration file for Part and Assembly mode follow. See the following categories that list the configuration option followed by a detailed description.

- Model Parameters
- Standard Datums
- Required and Unacceptable Parameter Notes
- Standard Model Notes
- Family Table Parameter
- Layer Move
- Layers
- Unwanted Layers for ModelUPDATE
- Length Units
- Mass Units
- Material Name
- Model Name
- Parameter Mapping for ModelUPDATE
- Parameter Rename
- Parameters

ModelCHECK - Help Topic Collection

- Unwanted Parameters for ModelUPDATE
- Pro/ENGINEER Build and Version
- Relation & Relation Comments
- Unwanted Relations for ModelUPDATE
- Sheet Metal Bend Table
- Tolerance Type
- Views
- Create Views for ModelUPDATE (Part mode only)
- Accuracy for ModelUPDATE

Drawing Mode Configuration Options for the Start File

Configuration options available in the start configuration file for Drawing mode follow. Click the category to see the configuration option and a detailed description.

- Model Parameters
- Drawing Format
- Drawing Note Fonts and Heights
- Drawing Layers
- Layer Move
- Model Name
- Parameters
- Parameter Rename
- Pro/ENGINEER Build and Version
- Drawing Symbols
- Drawing Table Cells
- Unacceptable Notes in Drawings
- Drawing Sheets to be Ignored
- Unwanted Layers for ModelUPDATE
- Parameter Mapping for ModelUPDATE
- Unwanted Parameters for ModelUPDATE

Setting Up External Files

About External Files

External files contain the standard values to be used during the checking process. For example, use external files to list the standard sheet metal wall thicknesses. You can specify the external files that ModelCHECK must use in the start configuration file.

To Set Up the External Files Using the PTC ModelCHECK Configuration Tool

1. Click  adjacent to **Text Files** in the left pane of the **PTC ModelCHECK Configuration Tool** dialog box.
2. Select the required text file. A table listing the contents of the file appears in the right pane of the **PTC ModelCHECK Configuration Tool** dialog box.

Note: Click **Create new file** to create a new external file.

3. Edit the contents using the boxes. You can add and delete rows as required.
4. Click **Save** or **Save as** to save your changes to the current or a different file, respectively.

To Manually Set Up the External Files

1. Open the file using a text editor. By default, external files are located in `<proengineer-loadpoint>/modchk/text/<language>/config/text`.
2. Add the contents in the appropriate format.
3. Save the file with the appropriate extension.

External Files Configuration Options for the Start File

Configuration options available in the start configuration file for external files follow. See the following category that describe the configuration option followed by a detailed description.

- Hole and Cut Diameter File
- Draft Angle File
- Sheet Metal Thickness File
- Custom Checks
- External Lists
- Drawing Detail File
- Drawing Information

- Relation Update File
- Regeneration Messages

Custom Configurable Checks

About Creating a New Check from Two or More Checks

You can use the outcome of two or more checks to create a new check. A situation in which a new check is useful is described as follows:

The total number of features reported by the `REG_FEATURES` check can divide the number of datum planes reported by the `DTM_PLANE_INFO` check. The results can be reported as `Number of datum planes as a percentage of all features` and a threshold can be set where an error is reported if the number goes over 25 percent.

The new check is listed in the check configuration file using the following syntax:

```
[CHK]_[user_defined_name]_[check_mode] YNEW E E E E Y
```

Where:

- `CHK` specifies that it is a custom check.
- `user_defined_name` is the user-defined and case-sensitive name of the check.
- `check_mode` is the mode in which the check is to be run. The mode can be `PRT`, `DRW`, or `ASM`.

The check definition is stored in a separate file and is specified in the start configuration file as follows:

```
CUSTOM_CHECKS_FILE custom_check.txt
```

The file can be named whatever you like. In this instance it is called `custom_check.txt`. If no path is given, the file is assumed to be in the `config` directory.

Example: Custom Check File

The custom check file contains the following information:

```
# Custom Check File
#
# CUSTOM1
DEF_CUSTOM1 (100 * DTM_PLANE_INFO/REG_FEATURES)
CND_CUSTOM1 GT 25
MSG_CUSTOM1 CUSTOM: Number of datum planes as a percentage of all
features
```

Each line in the `custom_check.txt` file is defined as follows:

- `DEF_(user_defined_name)` - Definition of check

The following operators are allowed: `LT`, `GT`, `EQ`, `NEQ`, `LTE`, and `GTE`.

- `CND_(user_defined_name)` - Definition of condition

The following operators are allowed: `LT`, `GT`, `EQ`, `NEQ`, `LTE`, and `GTE`.

A second set of constraints can be added by adding an `AND` or an `OR` operator. For example:

```
GT 20 AND LT 30
```

- `MSG_(user_defined_name)` - Report message

Note: Each line can be up to 256 characters long.

About Creating Custom Checks

You can create your own checks in addition to the checks that ModelCHECK provides. To do this you must use Pro/TOOLKIT to enable the checks and accordingly update the ModelCHECK configuration files.

Note: You must have a valid Pro/TOOLKIT license to write Pro/TOOLKIT applications. See the Pro/TOOLKIT documentation for information about the licenses and their use.

To Create Custom Checks Using Pro/TOOLKIT

1. Set the `CUSTMTK_CHECKS_FILE` configuration option in the start configuration file to a text file that stores the check definition as follows:

```
CUSTMTK_CHECKS_FILE text/custmtk_checks.txt
```

2. Set up the `custmtk_checks.txt` file to define the checks as follows:

```
# Custom TK Check File
# def-name of check as registered
# NOMATERIAL
DEF_NOMATERIAL CHKTK_NOMATERIAL_PRT
TAB_NOMATERIAL FEATURE
MSG_NOMATERIAL CUSTOM: Part has no material assigned
ERM_NOMATERIAL INFO: No material assigned to part
DSC_NOMATERIAL CUSTOM: Undefined material models
# SMALNAME
DEF_SMALNAME CHKTK_SMALNAME_PRT
TAB_SMALNAME FEATURE
MSG_SMALNAME CUSTOM: Part has short name
ERM_SMALNAME INFO: Part name length is less than 4 characters
DSC_SMALNAME CUSTOM: Short name models
```

where

- DEF_<checkname> defines the name of the check. The format must be CHKTK_<checkname>_<mode>, where mode is PRT, ASM, or DRW.
- TAB_<checkname> specifies the tab (category) in the ModelCHECK report under which the check is classified.

The options for the tab are INFO, PARAMETER, LAYER, FEATURE, RELATION, DATUM, MISC, VDA, and VIEWS.



- MSG_<checkname> specifies the description of the check that appears in the lower part of the ModelCHECK report when you select the name.
 - DSC_<checkname> is the name of the check as it appears in the ModelCHECK report table.
 - ERM_<checkname> INFO is used to specify the result of the check as an information message that appears in the lower part of the ModelCHECK report. This is useful in checks where the results do not need to be displayed as values but as a text message.
3. Add the check and its values to the check configuration file.
 4. Write a Pro/TOOLKIT application to enable the custom checks. This application registers the checks and the actions that you can perform for the checks from the ModelCHECK report. For details on how to write the application, refer to the Pro/TOOLKIT documentation.

Setting Up the Constant Configuration File

About the Constant Configuration File

The constant configuration file, or constant file, has the .mcn extension and contains the values of constants that ModelCHECK uses. Use the constant configuration file to specify constant values such as the length of a short edge. There can be several of these files. The condition file determines which constant file to use each time you run ModelCHECK.

To Set Up the Constant Configuration File Using the PTC ModelCHECK Configuration Tool

1. Click  adjacent to **Configuration settings** in the left pane of the **PTC ModelCHECK Configuration Tool** dialog box.
2. Click  adjacent to **Constant files**.
3. Select the required constant file. A table listing the constants and their values appears in the right pane of the **PTC ModelCHECK Configuration Tool** dialog box.

Note: Click **Create new file** to create a new constant configuration file. ModelCHECK dynamically updates all boxes listing constant configuration files in

the **PTC ModelCHECK Configuration Tool** dialog box with the name of the new file.

4. Edit the constants and their values using the boxes.

You can add and delete rows to add and delete constants, respectively.

5. Click **Save** or **Save as** to save your changes to the current or a different file, respectively.

To Manually Set Up the Constant Configuration File

1. In <proengineer-loadpoint>/modchk/text/<language>/config/constant, open a text file.
2. Add options to specify constant values. Save the file with the .mcn extension.
3. Create as many constant configuration files as required. The condition file determines the constant file for use.

Example: Constant Configuration File (.mcn)

```
# CONSTANT REPORT CONFIGURATION

SHORT_EDGE   CALCULATE
PERC_EARLY_ROUND 0.5
PERC_EARLY_CHAM 0.5
PERC_EARLY_DRAFT 0.5
SMALL_RADIUS 0.5
ACCURACY_LOW 0.0005
ACCURACY_UPP 0.0013
MIN_ABS_ACCURACY 0.001
MAX_ABS_ACCURACY 0.02
SHARP_ANGLE  10.0
GLOBAL_INTF_DAYS 1
MIN_TOLERANCE 0.1
SHORT_EDGE_BATCH 0.5
RC_PARAMETER_NAME PART_TYPE
PERC_EARLY_COSMETIC 0.7
MAX_SKETCH_ITEMS 100
MCSI1_TOL 0.100000
MCSI2_TOL 0.100000
MCSI3_TOL 0.100000
MCSI4_TOL 0.100000
MCSI5_TOL 0.100000
TINY_ELMNT_TOL 0.0012
TINY_ELMNT_AREA_TOL 0.020
TINY_DRW_ELMNT_TOL 0.020
ID_ELMNT_TOL 0.020
ID_DRW_ELMNT_TOL 0.020
POS_CONT_TOL1 0.100
TANG_CONT_TOL2 0.100
```

ModelCHECK - Help Topic Collection

```
CURV_CONT_TOL3 10.000
POLYN_DEG_TOL 11
KNOT_TOL 0.020
SELF_DIST_TOL 0.020
TINY_SEGMENT_TOL 0.200
CURVATURE_RAD_TOL 0.500
BOUND_ANGLE_MIN 1.000
BOUND_CRV_INT_TOL 0.09
BOUND_CRV_SRF_TOL 0.07
NUM_SEGMENT_TOL 2
KNIFE_EDGE_TOL 2.000
DIST_VERT_EDGE_TOL 0.020
DIST_VERT_FACE_TOL 0.020
```

Options in the Constant Configuration File

The constant configuration file has the following configuration options:

- SHORT_EDGE and SHORT_EDGE_BATCH
- PERC_EARLY_ROUND
- PERC_EARLY_DRAFT
- PERC_EARLY_CHAMF
- SMALL_RADIUS
- ACCURACY_LOW
- ACCURACY_UPP
- MIN_ABS_ACCURACY
- MAX_DRAW_SHEETS
- MAX_ABS_ACCURACY
- SHARP_ANGLE
- MIN_TOLERANCE
- RC_PARAMETER_NAME
- PERC_EARLY_COSMETIC
- MAX_SKETCH_ITEMS
- MCSI1_TOL
- MCSI2_TOL
- MCSI3_TOL

- MCSI4_TOL
- MCSI5_TOL
- GeomIntegrityCHECK Constants

Setting Up the Status Configuration File



About the Status Configuration File

The status configuration file, or status file, has the `.mcq` extension and contains the criteria for the status of the model. Several such files can exist. The condition file determines which status file to use each time you run ModelCHECK. The criteria are the number of errors and warnings.

ModelCHECK decides the status of the model as follows:

- **Green** - less than or equal to the number of errors or warnings for the `GREEN` option in the status configuration file.
- **Yellow** - less than or equal to the number of errors or warnings for the `YELLOW` option and greater than the numbers for the `GREEN` option in the status configuration file.
- **Red** - greater than the number of errors or warnings for the `YELLOW` option in the status configuration file.

To Set Up the Status Configuration File Using the PTC ModelCHECK Configuration Tool

1. Click  adjacent to **Configuration settings** in the left pane of the **PTC ModelCHECK Configuration Tool** dialog box.
2. Click  adjacent to **Status files**.
3. Select the required status file. A table listing the status definitions appears in the right pane of the **PTC ModelCHECK Configuration Tool** dialog box.

Note: Click **Create new file** to create a new status configuration file. ModelCHECK dynamically updates all boxes listing status configuration files in the **PTC ModelCHECK Configuration Tool** dialog box with the name of the new file.

4. Edit the status definitions using the boxes for the maximum number of errors and warnings.

You can add and delete rows to add and delete status definitions, respectively.

5. Click **Save** or **Save as** to save your changes to the current or a different file, respectively.

To Manually Set Up the Status Configuration File

1. In `<proengineer-loadpoint>/modchk/text/<language>/config/status`, open a text file.
2. Add the criteria for the status. Save the file with the `.mcq` extension.
3. Create as many status configuration files as necessary. The condition file determines the status file for use.

Example: Status Configuration File (.mcq)

```
GREEN 5E,10W
```

```
YELLOW 8E,15W
```

In the previous example:

- The status of the model is green if there are not more than 5 errors and (or) 10 warnings.
- The status of the model is yellow if there are not more than 8 errors and (or) 15 warnings.
- The status of the model is red if there are more than 8 errors and (or) 15 warnings.

Using the Spell Checker

About the Spell Checker

When ModelCHECK runs in Drawing mode, it checks for spelling errors. You can:

- Highlight the misspelled words.
- Automatically replace the misspelled words with a specified new word.
- Add the word to the dictionary as spelled correctly. The word remains accessible to all ModelCHECK users.

To Use the Spell Checker

1. Open or create a drawing.
2. Run ModelCHECK. If spelling errors are found, a link to a report page appears.
3. Click the link. Misspelled words are listed.
4. Perform the desired action.

Spell Checker Dictionaries

The spell checker has two dictionaries, `words` and `user_words`, both stored in `<modelcheck-loadpoint>/text/<language>/spell`.

- `user_words` - Standard dictionary. Add words from a ModelCHECK report here. All ModelCHECK users need read and write access to this file.
- `words` - Default dictionary. Do not modify.

ModelCHECK Reports

About ModelCHECK Reports

Each time ModelCHECK runs, the ModelCHECK report is created, the browser embedded in Pro/ENGINEER is maximized, and the report is displayed in the browser. The ModelCHECK report is HTML-based.

Note: The `SHOW_REPORT` configuration option in the `config_init.mc` file must be set to `Y` to display the ModelCHECK report in the browser.

Through the ModelCHECK report, you can highlight recommendations directly in Pro/ENGINEER or have ModelCHECK implement them automatically. In many cases, ModelCHECK also provides detailed supporting documentation about a recommendation.

The messages in ModelCHECK reports are fully customizable. You can change the wording of report items to include different terms or a different language. Language information is stored in three text files:

- `msg_mcmsg.txt`
- `msg_mcmisc.txt`
- `msg_mcdesc.txt`

You can configure ModelCHECK to create summary reports. ModelCHECK directly writes the summary reports to the directory specified by the `DIR_REPORT` configuration option in the `config_init.mc` file.

To Configure Report Titles

1. Browse to `<modelcheck-loadpoint>/text/<language>`.
2. Before you modify a file, create a backup.

Note: Preserve the format of any file you edit. Do not change the first two lines of each entry (the check name or the original message).





3. Edit the following files as required.
 - `msg_mcmsg.txt` - For all messages found in the detailed report.
 - `msg_mcmisc.txt` - For all miscellaneous strings not associated with a check.
 - `msg_mcdesc.txt` - For short check titles.

To Use the ModelCHECK Report

1. Use the links in the top-right corner of the report to see an assembly models report, the drawing models report, or a list of the failed checks for the entire assembly. The assembly report has links to reports of individual components of the assembly.
2. The tabs in the top bar of the report show the categories under which the checks are classified. Choose a category to see the results of specific checks.

Note: The **All** tab is chosen by default displaying the checks configured as errors or warnings.

3. The bar below the tabs shows the model name and its status. Click the arrow adjacent to the model name to see information about the model such as the date of the report, the operating mode, the configuration files used, the user who checked the model, the user who last saved the model, and the date when the model was created. Click  to generate and display a report that can be printed.
4. The table in the report gives a list of checks. Click the check boxes above the table to further refine the display of the checks as follows:





- Click the  check box to show the failed checks that have been configured as errors.
- Click the  check box to show the failed checks that have been configured as warnings.
- Click the  check box to show the information-only checks.
- Click the  check box to show the checks that are successful.

Note: Only the errors and warnings are shown by default. A number adjacent to each check box indicates the number of checks of each type.

The table has four columns as follows:

- A serial number
- The status of the check
- The name of the check
- The number of instances in the current part or assembly or information about the check

Note: You can sort the table based on the status, name, and results. By default, the table is sorted by the name of the check.

5. To access the online help for a check, click , , , or  to the left of the name of each check in the table. A page with information specific to the check appears.
6. Click the name of a check in the table to see its details and instances in the lower part of the report.

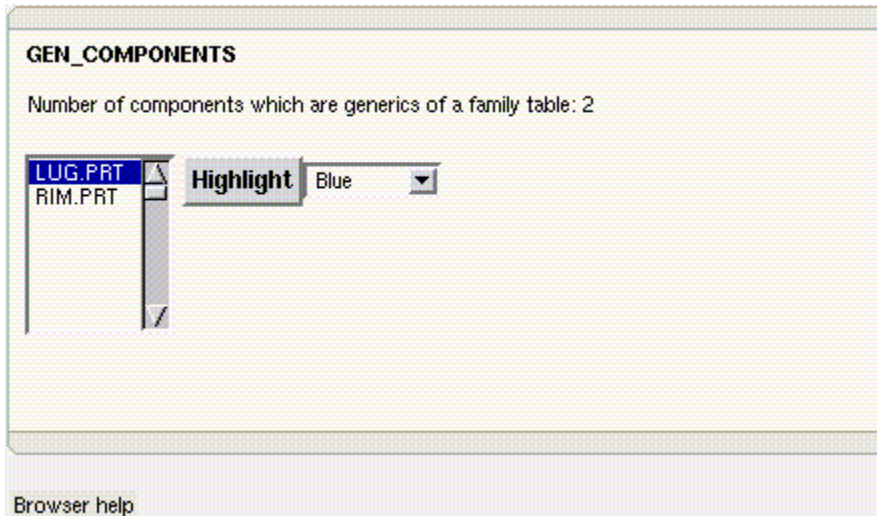

In the lower part of the report, you can perform actions on the model such as:

- Highlight a feature
- Ignore a problem
- Delete a feature
- Update information
- View references

Note: The actions vary for different checks.

Example: Modifying the msg_mcmsg.txt File

The following example shows how the msg_mcmsg.txt file can be modified. The DISK_SPACE entry has a default value of File Size. It was changed to Disk Space Used.

```
!
REPORT MESSAGES
! Language file for ModelCHECK for Ver 1.6.(8-25-97)
!
! Each check has 3 information lines:
! 1) The check name
! 2) The original (English) text for this check
! 3) The new (alt language) text for this check
!
!
# PART REPORT CONFIGURATION
```

ModelCHECK - Help Topic Collection

#

DISK_SPACE

File size:

Disk Space Used:

#

MEMORY_SPACE

Memory space:

#

INSTANCE_NAME

Instance name begins with the generic name:

Summary Reports

You can configure ModelCHECK to create HTML-based summary reports by setting the `HTML_FILE_OUTPUT` configuration option in the `config_init.mc` file to `Y`. The types of summary reports are:

- Summary report for single parts, assemblies, and drawings

The report files are named `<part_name>.p.dsumm.html` for parts, `<assembly_name>.a.dsumm.html` for assemblies, and `<drawing_name>.d.dsumm.html` for drawings.

- Bill of Materials summary report for assemblies

The report file is named `<assembly_name>.a.dabom.html`.



- Drawing and model summary report for drawings

The report file is named `<drawing_name>.d.ddbom.html`.

The summary reports and the corresponding XML-based reports are written to the directory specified by the `DIR_REPORT` configuration option in the `config_init.mc` file.

You can customize the XML-based summary reports to include additional information using the `mcctltempl.xsl` file located by default in `<modelcheck-loadpoint>/templates/`. Use the `HTML_FILE_OUTPUT_REPXSL` configuration option in the `config_init.mc` file to specify a different Extensible Stylesheet Language (XSL) file.

ModelUPDATE Report

If you have enabled the ModelUPDATE mode, the ModelUPDATE report is available by default under **Update** in the ModelCHECK report. Click the  check box to see the successful checks and  check box to see the unsuccessful checks. The

unsuccessful checks are also available in the ModelCHECK report; you can perform their updates from the ModelCHECK report.

Optimizing ModelCHECK

About Optimizing ModelCHECK for Speed

You can add a line to the `condition.mcc` file to have ModelCHECK skip checking certain models if a parameter exists or if its value is set to a specific value. If a model so designated is the member of an assembly on which ModelCHECK is running, the model is skipped. Consider the following to optimize ModelCHECK for speed:

- ModelCHECK is preconfigured to look for a model parameter called `NOCHECK`. If this exists, the model is skipped. Set up this model parameter by clicking **Tools** > **Parameters** and then creating `NOCHECK` as a string parameter using the respective boxes.

You can change the name of the parameter by editing the `condition.mcc` file as follows:

```
#OVERRIDE CHECKS
IF (<parameter_name>) NOCHECK
```

where `parameter_name` is the name of the parameter. If the parameter exists, the model is skipped.

- In Assembly mode, ModelCHECK automatically skips checking a model if the value of the `MC_ERRORS` parameter is 0 (it is a good model) and the model has not changed since it was retrieved.
- The most resource intensive checks follow. By disabling them, you can increase the speed of ModelCHECK by about 50 percent.

In Part mode disable:

- SHARP_EDGE
- SRF_EDGES
- ACCURACY_INFO
- SLA_INFO
- ADD_CHK_PARAM
- SHORT EDGE set to CALCULATE (use a value instead)
- SKETCH_ITEMS
- DUPLICATE_MODELS
- All GeomIntegrityCHECK checks

In Drawing mode disable:

- STD_DTL_SETUP

- NOTE_INFO
- DRW_SHEET_ALL set to Y in the `config_init.mc` file
- Set the `DIR_REPORTS` configuration option in the `config_init.mc` file to a directory on the local machine. With this setup, files do not have to be written across the network every time ModelCHECK runs. It is not important how the `DIR_METRICS` configuration option is configured. The metrics file is only written once when you exit Pro/ENGINEER.

RuleCHECK

About RuleCHECK

RuleCHECK, a component of ModelCHECK, allows companies to easily document and enforce important engineering rules. This tool can be used to develop a design advisor for Pro/ENGINEER users.

Rules can be defined to describe a company's engineering rules, design process steps, required deliverables, and Pro/ENGINEER best practices. Each type of part and assembly that a company designs can have specific rules assigned for it.

The RuleCHECK report shows the names and description of the rules applied to the model.

To Start RuleCHECK

1. Open a part or assembly.
2. Click **Analysis > ModelCHECK > ModelCHECK Rule Check**.

Types of Rules

Some types of rules a company can use are:

- Engineering rules

These rules can include required part thickness, clearances, draft angles, or materials. These rules capture a company's knowledge base on how to design high quality parts that are easy to manufacture. They can be used to offer design advice to new engineers.
- Design process steps

The effectiveness of Pro/ENGINEER is dependent on how it is used. For example, some assemblies are best designed top-down while others are best designed bottom-up. Often, once a type of assembly is built a number of times, the most efficient methodology becomes evident. It should be documented for all users.
- Required deliverables

In order to support downstream applications such as analysis, manufacturing, marketing, and ERP, Pro/ENGINEER users must define or create specific parameters, simplified representations, drawings, and neutral files.

- Pro/ENGINEER best practices

Pro/ENGINEER contains many advanced features that allow the efficient modeling of complex products. Unfortunately, many users are not well trained in functions such as user-defined features (UDFs), simplified representations, interchange, reroute, and how to properly use master models. Specific functions can be recommended for use on different types of models.

Defining Rules

RuleCHECK can attach different rules to different types of models. Model types are defined with the `RC_MODEL_TYPE` model parameter. This parameter allows you to use parameters that already exist in your model. RuleCHECK uses the `RC_MODEL_TYPE` parameter to determine which set of rules to associate with the model. You must define this parameter in each model. The existence and proper definition of this parameter can be checked by ModelCHECK.

Each set of rules is stored in a separate file. By default, the rule files are in `<proengineer-loadpoint>/modchk/text/<language>/rules`. These files can have any name, but must have a `.rule` extension. In order to associate a model with a set of rules, the value of the `RC_MODEL_TYPE` parameter and the rule file name must be the same. The following table illustrates this:

RC_MODEL_TYPE	Rule File Name
Steel	steel.rule
Sheetmetal	sheetmetal.rule
Casting	casting.rule

Two types of rules can be defined: soft rules and hard rules.

Soft Rules

Soft rules offer design advice to users. These general guidelines do not need to be followed specifically.

Hard Rules

Hard rules offer design advice that must be followed explicitly. RuleCHECK attaches a status to each of these rules. You must sign off that these rules have been satisfied. The status of each rule can be set to one of three states:

- **Pending** - The rule has been attached to the model, but it has not yet been applied. This is the default status.
- **Complete** - The rule has been applied to the model. You can also add comments to the rules. When you set a rule's status to complete, you have to sign off that the rule has been satisfied.

- **Override** - The rule has been overridden. If you cannot satisfy a rule, you must document that you attempted to conform to the rule, but could not. In order to continue you must enter the reason for overriding the rule.

When **Complete** or **Override** are chosen, a comment window becomes available in which you can type information such as your name, date, and the reason why you are changing the status of the rule.

Status changes are written to the Pro/ENGINEER model but are not written to the disk until the model is saved. Although the status is stored with the model, the only way for you to modify it is through RuleCHECK.

Implementing RuleCHECK

RuleCHECK can be used to offer advice and enforce design rules. It can also be used to document a design process for possible automation.

As a design advisor, RuleCHECK offers immediate access to a company's design knowledge. Often this information is stored in design manuals, industry design codes, and in the minds of senior designers. Engineers must know when and where to search for this information. Today, products are becoming more complex, design time is reduced, and there is considerable turnover and reorganization of engineering staff. Immediate access to correct and up-to-date engineering knowledge is critical to the success of many projects. With RuleCHECK, this information is made available in a proactive fashion and is integrated directly into the Pro/ENGINEER design environment.

When creating a design automation system for Pro/ENGINEER, the most critical step is to define the equations, rules, and design steps. Once these have been defined, it still requires considerable effort to capture these in software and then test and debug the system. Often during testing of the automation system, it is found that several important rules or conditions were not anticipated. It then requires a lot of time and effort to add these to the system.

With RuleCHECK, all the equations, rules, and design steps can be defined and presented to the users without developing any custom software. Designs are performed interactively in Pro/ENGINEER following these guidelines. As new rules and conditions are encountered, they can be easily added to RuleCHECK for future projects. Once most designs can be completed by explicitly following the steps defined by RuleCHECK, these steps can be captured in a Pro/TOOLKIT application to perform the design process automatically.

Integrating RuleCHECK with ModelCHECK

ModelCHECK includes a check to see if any hard rules have been attached to the model and whether these rules still have a status of pending. This is recorded as an error in ModelCHECK. This way ModelCHECK enforces a company's design standards and rules and makes users accountable for satisfying these rules. In the end, the design engineer is still responsible for creating good designs, but this allows companies to define standard practices and make sure that they are followed.

Example: Using RuleCHECK

The following example shows how RuleCHECK can be used to help you design a shell unit for a pressure vessel.

The `shell.rule` file contains the following rules:

- **Length** - Soft
- **Diameter** - Soft
- **Thickness** - Hard

And the file looks like this:

```
# Parametric Technology Corporation RuleCHECK Rule File
#
# Note: The name of this file should be the same as the model
# type that the rules apply to with the suffix '.rule'
#
# Lines in this file which begin with '#' are considered
# comments. The format of the rules in this file is:
#
#
# (Hard or Soft)
#
# EndOfRule
#
# The 'EndOfRule' indicates the end of the description, and
# description lines should be no more than 80 characters long
#
Length
Soft
1.00
RANGE: 72" to 360" (modify in skeleton part).
Should use 12" increments to avoid extra offcuts.
Set Skeleton parameter "SHELL_LENGTH" to desired value.
EndOfRule
#
Diameter
Soft
1.00
RANGE: 48" to 166"
Must be in 3" increments, limited by manufacturing equipment.
Set Skeleton parameter "OD" to desired value.
EndOfRule
#
Thickness
Hard
1.00
RANGE: 1/2" to 2"
MINIMUM THICKNESS = P*R/(S*E-0.6*P)
```

```
NomThk = 1/8" + MINIMUM THICKNESS(or 1/2" MIN).  
Modify Dimension "SHELL_THK" in the shell part to the desired value.  
EndOfRule  
#
```

The corresponding RuleCHECK report shows the names of the soft and hard rules. Select a name to see the description and the status of the rule if it is a hard rule. You can edit the status.

Using GeomIntegrityCHECK

About GeomIntegrityCHECK

The GeomIntegrityCHECK utility:

- Ensures that models adhere to the Verbund der Automobilindustrie (VDA) 4955 design specifications. VDA 4955 is an automotive standard for model quality.
- Validates the geometry in a model and identifies areas that could make it difficult to import a model into a downstream application or another CAD system.
- Presents problems, if any, in a comprehensive report with details of all geometry information in a model. This report is similar to the one created by ModelCHECK. From this report, you can highlight problems in the Pro/ENGINEER models.

Alternatively, you can set the `MC_VDA_RUN` configuration option in the `config_init.mc` file to run GeomIntegrityCHECK along with ModelCHECK and display the report in the ModelCHECK report. Use Pro/ENGINEER to repair the models.

To Set Up GeomIntegrityCHECK

1. In the left pane of the **PTC ModelCHECK Configuration Tool** dialog box, click **GeomIntegrityCHECK settings**.

The GeomIntegrityCHECK configuration options appear in the right pane of the **PTC ModelCHECK Configuration Tool** dialog box.

Note: The `config.gmc` file must be available in the directory specified by the `$MCDIR` environment variable and must have access permissions. If the file is not available, the GeomIntegrityCHECK configurations options are not visible. However you can run GeomIntegrityCHECK. In this case, GeomIntegrityCHECK uses the `config.gmc` file in the system directory, in which configuration files are stored. The path of the file is as follows:

```
<modelcheck-loadpoint>/text/<language>/config/config.gmc
```

2. Under **Configuration File**, the names of the default configuration directory and the default configuration file are displayed in their respective boxes.
 - **Load** - Load configuration files for the geometry integrity checks. Different checks are performed for different types of models. Some checks must be turned off when you are checking a particular model.

- **Save** - Save changes in the default file (`config.gmc`), the name of which is displayed in the **Config File** text box.
- **Save As** - Save in a separate file the changes you made to the default check values. The file can be retrieved later when checking a particular shape.

Note: You can give a new configuration file any name, as long as it has the `.gmc` extension.

- **Reset** - Reset check values to those that are in the file that is displayed in the **Config File** box.

Note:

- When you change the default check values, the changes remain in effect for the remainder of that session. The default settings reappear when Pro/ENGINEER is started again.
- Configuration files can be stored in two locations:

MCDIR - The environment variable used to specify the location of configuration files.

Working directory - The directory in which you store the files you created.

3. Under **Geom Checks and Allowed Values**, set the check values. This information is described in more detail in the following topics:
 - All Geom Type Checks
 - Curve and Drawing Checks
 - Surface Checks
 - Face Checks
 - Topology Checks
 - Solids Checks

To Start GeomIntegrityCHECK

To start GeomIntegrityCHECK when running ModelCHECK interactively on the current model:

1. Click **Analysis > ModelCHECK**. The **ModelCHECK** menu appears.
2. Click the **ModelCHECK Geometry Check** command on the menu. GeomIntegrityCHECK functionality starts, and the **Geometry CHECK** dialog box opens.
3. In the **Model to Check** list, click the name of the file containing the model that you want to check. In Part mode, you can check only the part in the current session. In Assembly mode, you can either select any component of the assembly or click **Check Sub-Models** to check all the components of the assembly.

4. Under **Text Report**, in the **Report Name** box, type a name for the **GeomIntegrityCHECK** report, or accept the default name, that is, `<name of model>.a.vda.mct` for assemblies and `<name of model>.p.vda.mct` for parts.

Two reports are created when **GeomIntegrityCHECK** is run:

- The standard HTML report that the user sees
- A text-based report

The text report is stored in the specified directory. You do not see this report, but it can be used as reference.

5. Click **OK** to start the checking process, or click **Cancel** to enter new settings.

Setting Check Criteria

Note: If you set the `MC_VDA_RUN` configuration option in the `config_init.mc` file to run **GeomIntegrityCHECK** along with **ModelCHECK**, the check criteria and values are read from the **ModelCHECK** check configuration and constant configuration files.

Before you set the criteria for a particular check, click **Load** in the **PTC ModelCHECK Configuration Tool** for **GeomIntegrityCHECK settings** to select a configuration directory and a configuration file. The names of the selected configuration directory and configuration file are displayed in the **Config Directory** and **Config File** boxes, respectively.

When you select the desired file, all of the required criteria and their values are shown. By default, they are read from the `config.gmc` file in the directory specified by the `$MCDIR` environment variable.

Note: The configuration file must have the `.gmc` extension.

The tabbed pages under **Geom Checks and Allowed Values** contain the criteria used to check models. These are default values that **ModelCHECK** retrieves from the configuration file. The values are listed in millimeters. **ModelCHECK** converts them automatically if they are entered in a different unit of measure.

After you make your choice of settings, you can save the settings to the same configuration file or a new configuration file. If you save them to a new configuration file, you can reload the file later by clicking **Load**. When you save a file, the `.gmc` extension is appended.

GeomIntegrityCHECK Configuration Options and Their Settings

All the **GeomIntegrityCHECK** checks and their configuration options and default settings are listed in the following table. For details, see the topics for the checks.

In the Default Status column, E stands for error warning. This means that when a check is set to E, **GeomIntegrityCHECK** reports as an error any lack of compliance with the default setting for that check.

Check Name	Configuration	Default Status	Default Setting
Tiny elements	M1_TINY_ELMNT	E	0.020 mm
Identical elements	M2_IDENTICAL_ELMNT	E	0.020 mm
Position continuity	M3A_POSITION_CONT	E	0.020 mm
Tangential continuity	M3B_TANG_CONT	E	0.100 mm
Curvature continuity	M3C_CURV_CONT	E	10.000 mm
Polynomial degree	M4_POLYN_DEG	E	11°
Waviness	M5_WAVINESS	E	N/A
Knot distance	M6_KNOT_DIST	E	0.020 mm
Distance from itself	C7_SELF_DIST	E	0.020 mm
IGES conform text	D28_IGES_TEXT	E	N/A
Tiny segment edge	SU8_TINY_SEG_EDGE	E	0.200 mm
Minimal curvature radius	SU9_TINY_CURV_RAD	E	0.500 mm
Angle between edges	SU10_BOUND_ANGLE	E	2°
Reversal of normals	SU11_NORM_REVERSAL	E	N/A
Patch distribution	SU12_PATCH_DIST	E	N/A
Unoccupied patch rows	SU13_UNOC_PATCH_ROW	E	N/A
Penetration/distance of boundaries	F14_BOUND_DIST	E	0.020
Proximity of boundary curve to its surface	F15_SURF_DIST	E	0.020
Parallel Path/similar Orientation	F16_SIM_ORIENT	E	N/A
Number of segments in a boundary curve	F17_NUM_SEG	E	2
Junction / number of faces per edge	T18_NUM_FACE	E	3

Check Name	Configuration	Default Status	Default Setting
Orientation of similar normals	T19_NORMAL_ORIENT	E	N/A
Knife edge	T20_KNIFE_EDGES	E	2.000
Distance to vertex edge	SO21_DIST_VERTEX_EDGE	E	0.020
Distance to vertex face	SO22_DIST_VERTEX_FACE	E	0.020
Deletion of history	SO23_HIST_DELETE	E	N/A
Auxiliary geometry	SO24_EXTRA_GEOM	E	N/A
Cavities	SO25_CAVITIES	E	N/A
Multi-body solids	SO26_MULT_BODY	E	N/A
Multi-solid parts	SO27_MULT_SOLID	E	N/A

All Geom Type Checks

When you click the **All Geom Type** tab in the **Geometry CHECK** dialog box, a tabbed page appears. This page contains the following checks:

- Tiny Elements
 - In wire geometry (default check setting: > 0.02 mm):

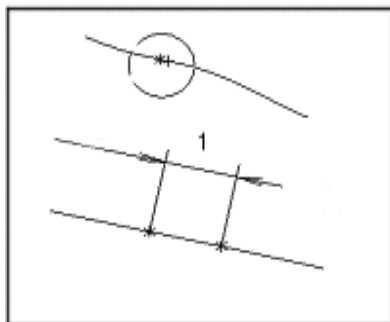
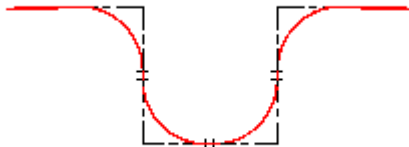

1. TOL

GeomIntegrityCHECK reports the elements in your model that are smaller than specified in your configuration files. It also suggests the changes that would make the model VDA-compliant. For example, you can delete a reported tiny element if it is not required for development of higher-ranking geometry.

Elements that fall short of a specific size in particular geometric operations (such as scaling and generation of offsets), in exchange of data (for example, with a system of lesser accuracy), or through further processing can lead to invalid elements and, consequently, to gaps. These elements usually occur through creating rounds and through closing mechanisms during bridging of small gaps or by overlapping.

Recommended solution:

Make the tiny elements superfluous by extending (extrapolating) the elements to be joined. Then delete the tiny elements. Alternatively, enlarge the tiny elements and correspondingly shorten the elements to be joined.

- In surfaces (default check setting: > 0.02 mm):

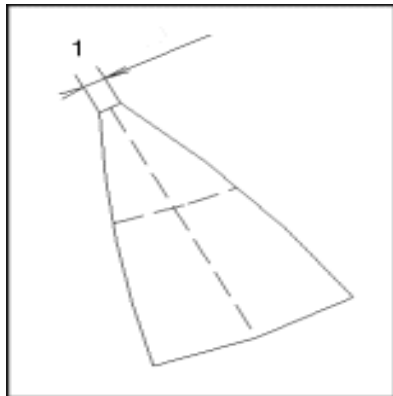

1. TOL

GeomIntegrityCHECK reports the faces and face patches whose length in at least two opposing directions is smaller than specified in your configuration file. This error can result in defective elements due to changes in the system or in the tolerance range. However, deletion of the faces or face patches can lead to gaps in the topology.

In addition, faulty tiny elements require larger storage space and increase the likelihood of continuity problems. These elements often occur as a result of system automation and the automatic closure of gaps in the when data is imported from other systems.

GeomIntegrityCHECK also reports the patch strips whose smaller extents have a less than 1:100 proportion in relation to a neighboring patch. Such size ratios are a sign of poor partitioning.

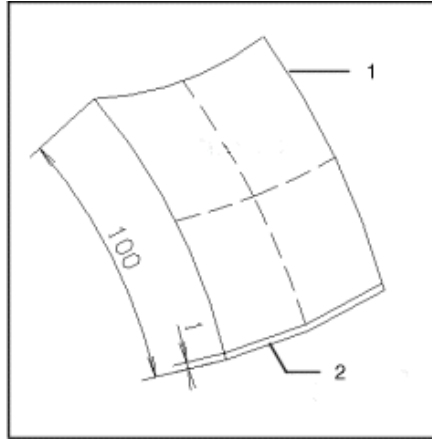

1. Patch 1
2. Patch 2

GeomIntegrityCHECK marks ten equidistant points on each of the four boundary or segment curves. Then it calculates the chord length from the resulting traverse paths. If all four chord lengths or two opposing chord lengths of an element are smaller than the 1% tolerance specified in your configuration file, in comparison to a neighboring segment, the element is reported.

Recommended solution:

Avoid tiny elements or make them superfluous by enlarging and subdividing the neighboring elements.

Note: A surface is the base face of a part that can protrude beyond the contours of the part. Surfaces are generally bounded with simple mathematical boundary curves and usually serve as a surface for the bounded surfaces with complex edge curves.

Surfaces can be composed of several segment faces called patches. These can be bound within the bounds of internal tolerances for position and gradients. Depending upon the number of segments (n , m) of the boundary curve, a surface is formed from a group of (n) times (m) patches.

- In bounded surfaces:

GeomIntegrityCHECK reports bounded surfaces that are smaller than specified in your configuration file. It calculates the face contents of a bounded surface and compares them with the VDA minimum value for that check.

Faces that fall short of the value in your configuration file can lead to invalid elements and thereby to gaps, especially with certain geometrical operations (for example, scaling formation of offsets), during the exchange of data (in a system with inferior exactness), or by subsequent processing (NC).

Recommended solution:

Delete the bounded surface. Enlarge and adapt the neighboring elements accordingly.

Note: Clearly defined faces, also called bounded surfaces, or faces, describe the geometrical surface of an object, if applicable, inclusive of holes, indentations, recesses, and so on, on the surface that forms the basis with boundary curves that are projected upon it. The boundary curve is an endless continuous curve.

- In solids:

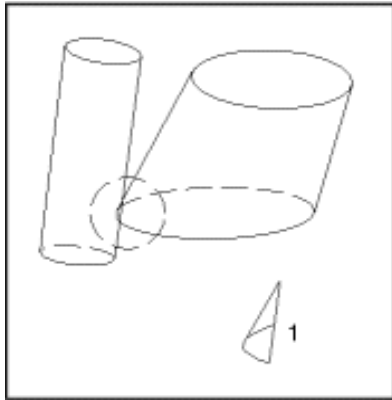

1. $\epsilon = \text{TOL}$

GeomIntegrityCHECK reports the solids whose expansion in two spatial directions is smaller than specified in your configuration file.

The three main directions of expansion (for example, the main axis of inertia) in a rectangular solid are examined. If the extension of the solid is smaller in two coordinate directions than specified in your configuration file, the element is reported.

The volume of the solid is also checked against the value in the configuration file. If the volume is smaller than specified, the solid is reported.

Recommended solution:

Delete the marked tiny elements as long as they are not associatively connected with other geometry.

Note: All the bounded surfaces in a solid form a surface group. GeomIntegrityCHECK checks every face in a surface group.

- In drawings:

GeomIntegrityCHECK reports the drawing elements that are smaller than specified in your configuration file.

- Identical Elements (mm)
 - In wire geometry (default check setting: > 0.02 mm):

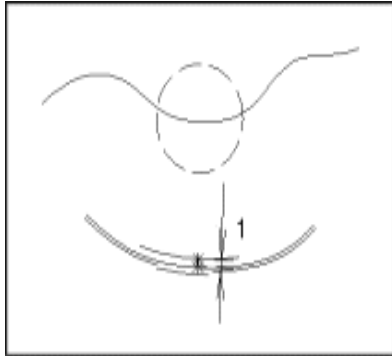

1. TOL

GeomIntegrityCHECK reports those elements that are identical to other elements in the same model. Occurrence of such elements often results from importing geometry into the model.

Identical, or double, elements unnecessarily increase the space requirements of a model. They can also impede NC and Finite Element Method (FEM) operations as well as the automatic recognition of continuous curved lines.

Recommended solution:

Carefully determine which of the identical elements to delete, and then delete it.

- In surfaces:

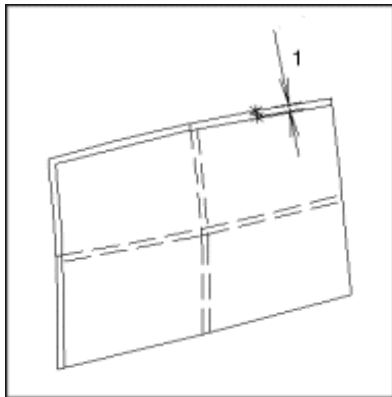

1. TOL

Identical elements obstruct the automatic creation of topology. The recommended solution is to delete one of the double elements in an identical pair. Be sure that you retain the required element.

- In drawings:

During the generation of a drawing, identical elements (that is, several lines of varying or equal length over one another) can occur unintentionally, which unnecessarily enlarges the space requirements of the model. Identical elements often hinder, for example, the automatic recognition of continuous curve paths.

Recommended solution:

Delete identical elements. As long as the elements are identical, the duplicates can be deleted without any problem. Where several elements of varying length are arranged vertically, under certain circumstances, you should determine the longest element and delete the shorter ones.

- Position Continuity

Note: A curve path consists of one or more curves with several internal segments. Generally, there are continuity requirements that have to be fulfilled on the borders of segments and curves. These are position continuity, tangential continuity, and curvature continuity.

- In wire geometry (default check setting: < 0.02 mm):

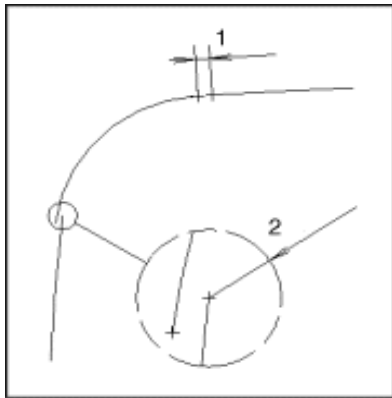

1. TOL

2. TOL

When verifying position continuity, GeomIntegrityCHECK reports discontinuities in curve and curve-segment transition points that exceed the TOL1 configuration tolerance. Such errors can cause problems in follow-up operations that build on the unity of curve paths, especially after scaling and transfer within a system environment of high accuracy.

Curves are checked for continuity in position, gradient, and curvature in relation to their segments. End and starting points of neighboring curve segments or curves are checked for sufficient distance with the aid of a 3-D intercept configuration tolerance TOL1. If the distance exceeds the tolerance, the curves are reported.

Recommended solution:

Insert a small fill piece, possibly a tiny element, in the gap that makes the discontinuity too large.

- In surfaces:

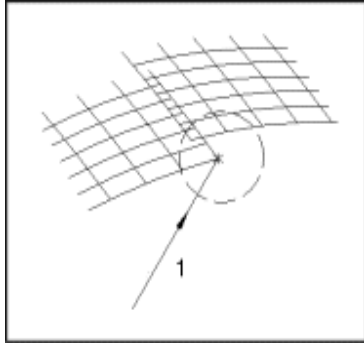

- 1. TOL

GeomIntegrityCHECK checks individual bounded surfaces and their segments for continuity in position, gradient, and curvature at several points. It reports discontinuities.

Recommended solution:

Regenerate the surfaces using the correct fundamental conditions.

- In topologies:

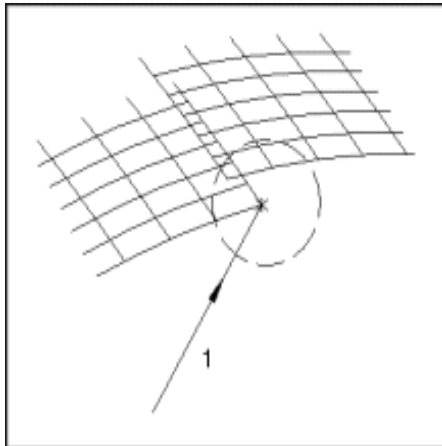

- 1. TOL

GeomIntegrityCHECK checks at several points the parity of two common boundary curves. If the gap between the curves exceeds the TOL1 gap configuration tolerance, GeomIntegrityCHECK reports the affected face boundary.

Bounded surfaces and their associated formations describe the surfaces of component parts and operation equipment. For this reason, the continuity of the bounded face has a special significance.

Position continuity, that is, continuous transition of bounded surfaces within a topology, is the most important quality characteristic within any surface group. A permissible discontinuity that is within the bounds of the tolerance can lead to a loss of the topology in the case of a change in the system or in the range of tolerances. It can also cause some systems to perform an automatic correction (healing). Because of this, unintentional changes, or new tiny elements, can occur.

Tangential or curvature discontinuity can have an effect on the surface quality or on the ability to mill the object.

Recommended solution:

In the case of gaps in face transitions, regenerate the affected faces with common boundary curves.

Note: To determine the continuity of a structure created from bounded surfaces, the topological association of these surfaces must be established, in case this has not been fulfilled through topology elements.

Neighboring bounded surfaces, which together form a particular part or complete surface of an object, are called composite surfaces, surface groups, or topology. Within a topology, special requirements apply regarding the faces in the boundary curves.

- Tangential Continuity
 - In wire geometry (default check setting: $< 0.1^\circ$):

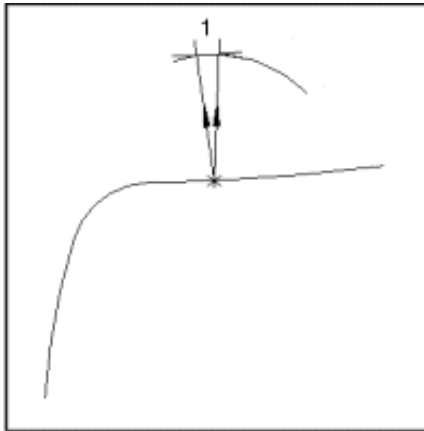

1. W_TOL

Tangential continuity means kink-free transition of two curves without a change in the tangential angle. A tangential discontinuity is generally visible and can be felt. Tangential discontinuities may be necessary in chamfers, bevels, and character lines, but in other types of models they are usually considered errors.

GeomIntegrityCHECK reports the curve segments or curves whose tangential angles exceed the TOL2 configuration angle value.

Recommended solution:

Interactively correct the curves by recreating them with identical tangent conditions or by rounding them with an additional curve with suitable tangent specifications. For example, round off two straights with a radius.

- In surfaces:

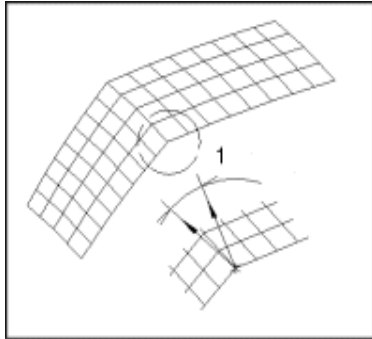

1. W_TOL

GeomIntegrityCHECK measures and compares tangential angles of two segments along a common border. If the maximum difference among the angles exceeds the configuration angle tolerance TOL2, the affected segment boundary is reported.

- In topologies:

The tangency angle or normal angles of two faces in a common boundary curve are checked at several points. If the angle difference exceeds the configuration angle tolerance TOL2, GeomIntegrityCHECK reports the affected boundary curve.

- Curvature Continuity

- In wire geometry (default check setting: < 10%):

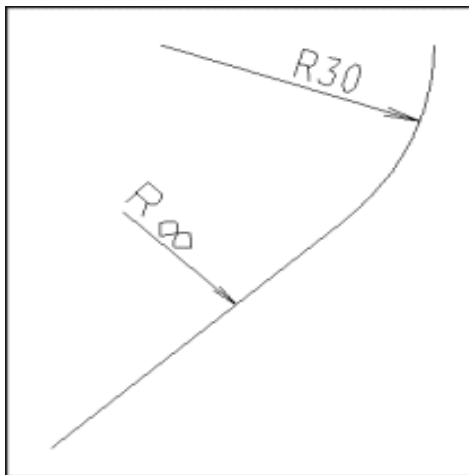

GeomIntegrityCHECK measures the curvature radii in curves and curve segments. It reports the curves and curve segments where the relative difference of the radii exceeds the configuration curvature tolerance TOL3.

Curvature continuity means parity of the curvature radius at the contact point with the curve and the resultant smooth curvature transition between two curves. Curvature continuity of curves is usually required only in parts with special functions, such as cams and worms, or due to stylistic elements.

Recommended solution:

Replace the faulty elements with elements that have suitable curvature conditions at each end. For example, elements with constant curvatures, such as straight lines and circles, should be replaced with free-form curves.

- In surfaces:

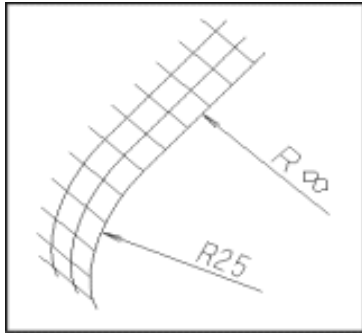

GeomIntegrityCHECK checks the curvature radii of two segments at several points along the common border. If the maximum relative curvature difference is greater than the configuration curvature tolerance TOL3, the affected segment boundary is reported.

- In topologies:

GeomIntegrityCHECK checks the curvature radii of two faces at several points in a common boundary curve. If the relative curvature difference exceeds the configuration curvature tolerance TOL3, the affected boundary curve is reported.

- Polynomial Degree
 - In wire geometry (default check setting: $< 11^\circ$):

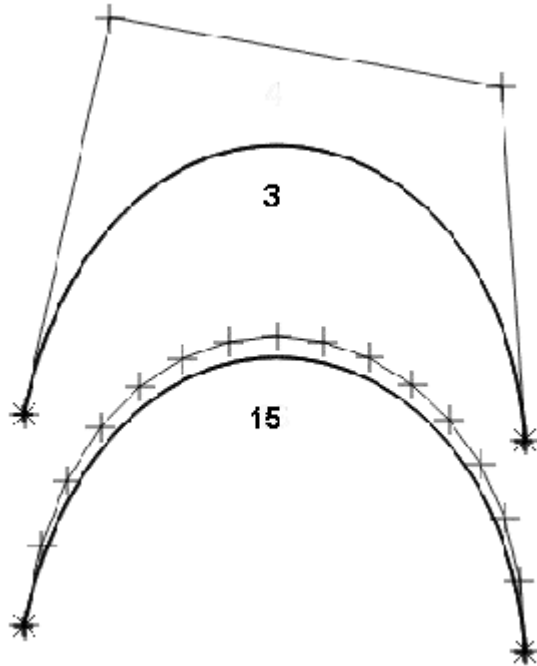

GeomIntegrityCHECK reports the curves whose polynomial degrees exceed the upper limit specified in your configuration file.

The degree of the polynomial depiction of a curve segment determines the degree of variance of that curve. The higher the degree, the greater the complexity of the curve.

Curves with high polynomial degrees are susceptible to unwanted curvature. Therefore, where appropriate, such curves must be approximated within the bounds of a tolerance when imported from or exported to another CAD system.

Recommended solution:

Avoid polynomial degrees greater than 9° . Practical experience has shown that polynomial degrees of up to 6° have proved to be the best. Unnecessary curves must be subdivided carefully into curves with lower degrees.

- In surfaces:

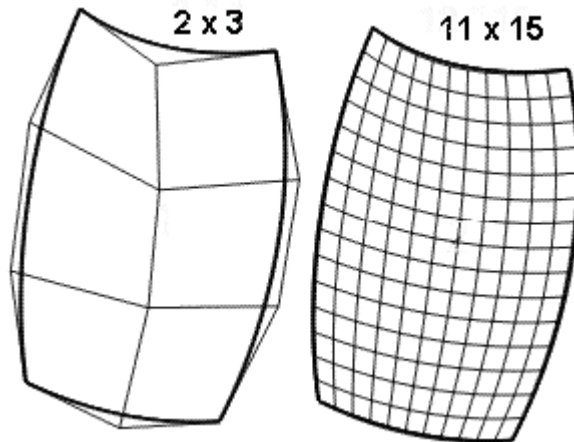

GeomIntegrityCHECK reports the surfaces where the polynomial degree in at least one parameter direction exceeds the upper limit specified in your configuration file.

A polynomial degree that is too high can lead to oscillations or, in the case of a reduction of the degree through approximation, to deterioration of the data quality with respect to faithfulness of form, storage requirements, and continuity.

Recommended solution:

Avoid polynomial degrees greater than 9°. Practical experience has shown that polynomial degrees of up to 6° have proved to be the best. Unnecessary curves should be subdivided carefully into curves with lower degrees.

- In drawings:

GeomIntegrityCHECK reports the curves whose polynomial degree exceeds the upper limit specified in your configuration file.

Curves with high polynomial degrees must be approximated during a transfer to another CAD system, that is, they must be approximated within the bounds of the configured tolerance and subdivided. If it is the case that the receiving system is only able to process curves with a particular maximum polynomial degree, it is possible that these curves could be falsely interpreted or ignored.

Recommended solution:

Compare the polynomial degree of curves with the given maximum value and, if appropriate, approximate through a curve of lesser degree, but with more segments, considering the specified tolerance.

- Waviness (default check setting: waviness is not allowed in a model; see the following definition):

- In wire geometry:

The waviness of a planar curve is checked through the number of sign changes along the curvature of the visible range of the curve.

A curve is rated as wavy if the sign changes more than once within a single segment or more than twice within a triple segment. The change of signs in the curvature should be taken into account only if the sum of the curvature on both sides of the change of signs is larger than a variable lower limit.

- In surfaces:

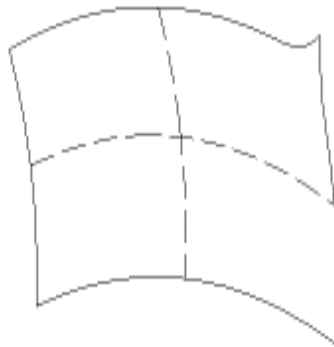

GeomIntegrityCHECK checks the waviness of a bounded surface by examining the number of sign changes along the length of the isoparameter lines $u=u_1$ to $u=u_n$ and $v=v_1$ to $v=v_m$.

A face with more than three sign changes along the total length of a parametric line or with more than one sign change within one of its segments is rated wavy. The frequency of sign changes is taken into account only if the curvature on both sides of a sign change is larger than a variable lower limit.

Recommended solution:

Regenerate the surface with correct fundamental conditions, such as the degree, edge curves, or restart points.

- Knot Distance
 - In wire geometry (default check setting: > 0.02):

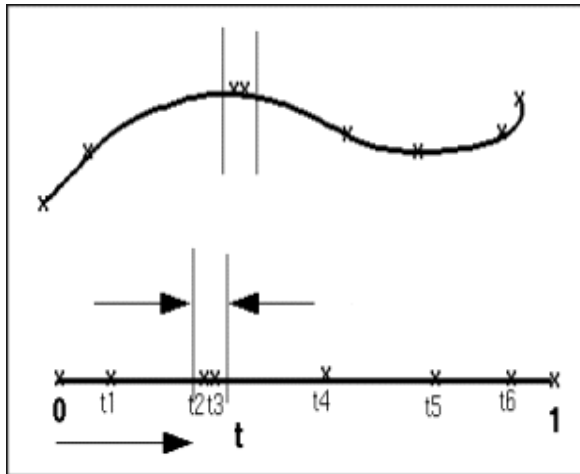

GeomIntegrityCHECK examines the knot vectors of NURBS curves for pairs of identical knots within the variable tolerance.

A knot vector is required for the definition of NURBS and B-Spline curves. The vector defines, among other things, the number of curve segments and the continuity of transitions between the individual curve segments.

The vectors are defined through a series of real numbers. Individual knots can be positioned on top of one another, known as multiple weighting of knots or multiple knots.

Recommended solution:

Regenerate the curves with large enough knot clearances.

- In surfaces:

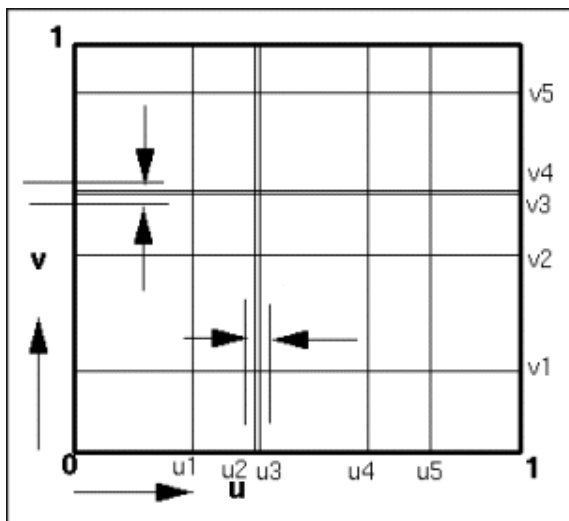

As is the case with NURBS and B-Spline curves, a knot vector for every parameter direction is required for the definition of NURBS and B-Spline

faces. These define the number of face segments in the u and v parameter directions and the continuity of transitions between themselves. The knot vector is defined through a series of real numbers.

After a transfer of knots to a system environment with coarser tolerances, it is possible that neighboring knots can be identical in this new environment and, consequently, the internal continuity within the face can become undesirable.

After you have determined all the settings for the **All Geom Type** checks, click **OK** to start the checking process, or click **Cancel** to specify new settings.

Curve and Drawing Checks

When you click the **Curve & Drawing** tab in the **Geometry CHECK** dialog box, a tabbed page appears. It contains the following checks:

- **Distance from Itself** - GeomIntegrityCHECK checks the proximity of the boundary-curve bounded surfaces to appurtenant surfaces. It reports the boundary curve if the curve extends beyond the parameter range of the surface.
- **Self-Penetration** - GeomIntegrityCHECK checks all bounded surfaces to ascertain whether or not, within the set tolerance, the face curve paths that form the boundary intersect themselves or whether face curve paths of a bounded surface interpenetrate or have contact with one another. Those that do are reported.

Self-penetrating curves:

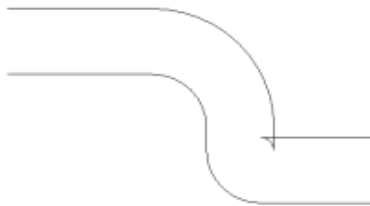

Self-penetration has no design purpose. It is always an error. It causes problems with other geometrical operations, such as the generation of offsets or faces, as well as with NC programming.

Recommended solution:

Regenerate the curves correctly.

- **IGES Conform Text** - In drawings, GeomIntegrityCHECK reports text that does not conform to IGES fonts.

During the generation of text and dimensioning, special characters and mutated vowels (umlauts), as well as β can lead to transfer problems. An excessively high number of text characters (>70 per line) as well as multi-line text can lead to loss during transfer and are for that reason to be avoided. Alternatively, a special agreement concerning the problem must be reached.

Recommended solution:

Replace special characters, umlauts, and β (for example, \ddot{a} with ae; β with ss).
Text with more than 70 characters must be divided into several shorter texts.
Multi-line text must be replaced with several single-line texts.

After you have determined all the settings for the **Curve & Drawing** checks, click **OK** to start the checking process, or click **Cancel** to specify new settings.

Surface Checks

When you click the **Surface** tab in the **Geometry CHECK** dialog box, a tabbed page appears. This page contains the following checks:

- **Tiny Segment Edge** (default check setting: > 0.02 mm) - GeomIntegrityCHECK reports the faces and face patches whose extents are smaller in one parameter direction than specified in your configuration file.

A face patch with one segment edge below the tolerance can lead to undefined normals in case of a change in the system or tolerance range.

- **Minimum Curvature Radius** (default check setting: > 0.5 mm) - GeomIntegrityCHECK reports the ranges of naturally bounded surfaces in which the curvature radius is less than the value in your configuration file. It also reports the places in which the normal to a face is not defined and where no curvature radius can be determined.

GeomIntegrityCHECK examines face points in a model and compares the maximum positive and negative curvatures with the limiting value specified in your configuration file.

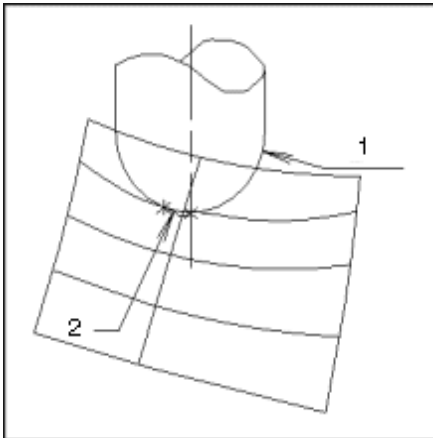

1. R_TOL
2. R

The curvature radius of a face must not fall short of the set value at any position, as lesions can occur on the face during milling. The minimum curvature radius of a face also limits the maximum clearance of an offset face.

Recommended solution:

Recreate the faulty faces through approximation or smoothing.

- **Angle Between Edge Curves** (default check setting: $2^\circ < A < 178^\circ$) - GeomIntegrityCHECK checks whether the angle between the boundary curves of naturally bounded surfaces lies within the critical range around 0° or 180° or not. It measures the angles between the tangents of neighboring boundary curves and compares them with the specified configuration value.

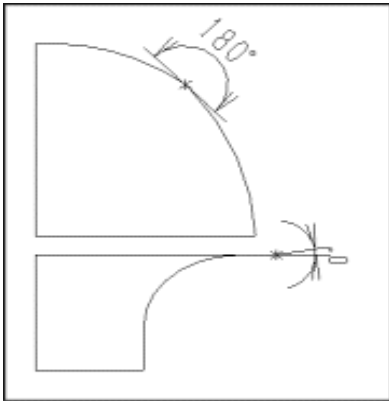

This error can result in undefined normals in the corner points.

Recommended solution:

Subdivide the surface or enlarge it and generate the required area as a face. The cases in which the normals on the edge of the face and in the corners are defined, despite a critical angle, can be ignored if the recipient of the data is in agreement.

- **Reversal of Normals** (default check setting: reversal of normals is not allowed in a model) - GeomIntegrityCHECK reports the ranges of naturally bounded surfaces in which it finds a significant local change in the difference of the normal angle.

It generates four corner normals in the face segment, a normal at each of the parametric center points of the four edges and in the center of the face. Then it makes comparisons within each group.

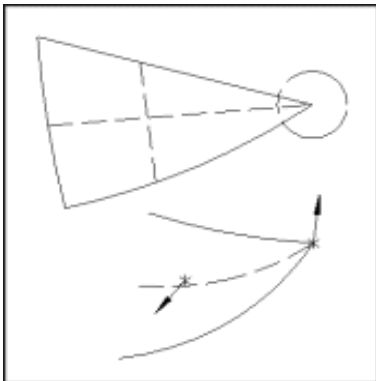

Generally, all points on a normal vector are shown facing uniformly either toward or away from a component. Occasionally, deviations occur on the edges of

surfaces. As a result, damage to the work piece can occur, because a tool can cut into the face.

A special case of the folded-down or flipped-over normal at an edge can often be found at the tip of a quasi-triangular patch. This is especially the case when two boundary curves that meet at a point project slightly beyond the point of intersection.

The largest corner difference must not exceed the specified value. The specified value may be changed to 120° in order not to mark the faces with constant changes in the normals.

Recommended solution:

Recreate the faces on which the vectors for normals have been turned around. When doing so, carefully consider the tangential conditions at the periphery.

In a case in which a vector at the tip of a triangular patch is flipped or turned around, the tip (within the bounds of admissible gaps and tiny elements) can be cut off so that the new fourth edge of the patch receives an admissible length. Alternatively, a three-sided bounded face with correct normals can be generated.

- **Patch Distribution** - GeomIntegrityCHECK reports the surfaces on which the number of patches exceeds the number specified in your configuration file.

A high number of patches on a surface is generally a sign of unfavorable complexity or size of the surface. This occurs as a result of, for example, poor approximation of a face of high degree to one of a lower degree, or as a result of an amalgamation of areas with different curvatures in a face.

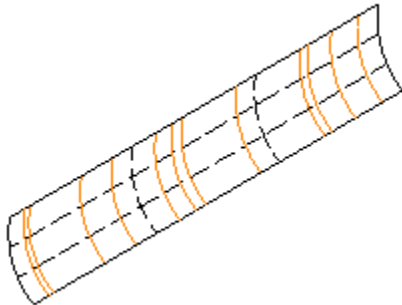

Recommended solution:

Demarcate the surfaces with large curvature differences. A surface with harmonic curvature distribution and a large number of smaller segments can be replaced with a surface of a higher degree.

- **Unoccupied Patch Rows** - GeomIntegrityCHECK reports the surfaces with unoccupied patch rows. That is, GeomIntegrityCHECK reports the patch rows on every outside boundary curve of a bounded surface with boundary curves.

Unoccupied patch rows:

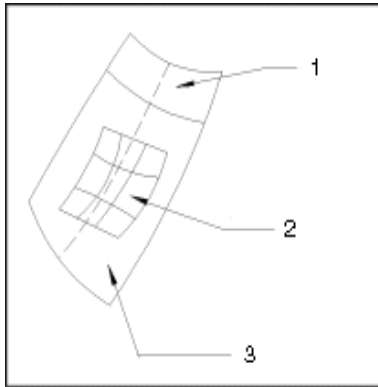

1. Patch 2
2. Face
3. Patch 1

The area of a face that is occupied by a bounded face can, in individual cases, be so small that whole rows of patches are unoccupied. These rows unnecessarily take up valuable storage space. Generally, they can be erased without difficulty.

Note: Sometimes the unoccupied face domains are required in subsequent process steps. Their reconstruction is time consuming. For this reason, there is no general recommendation for elimination of unoccupied patch rows. If required, subdivide the surface along an appropriate patch border and completely delete the unoccupied surfaces.

After you have determined all the settings for the **Surface** checks, click **OK** to start the checking process, or click **Cancel** to specify new settings.

Face Checks

When you click the **Faces** tab in the **Geometry CHECK** dialog box, a tabbed page appears. It contains the following checks:

- **Penetration or Distance of Boundaries** (default check setting: > 0.02 mm) - GeomIntegrityCHECK reports instances of penetration or contact of boundary curves caused by using values lower than the minimum distance tolerance.

Penetration, or contact, of boundary curves caused by using values lower than the minimum distance tolerance can lead to invalid faces (loss of face definition) and to loss of integrity of a topology by a change in the tolerance environment.

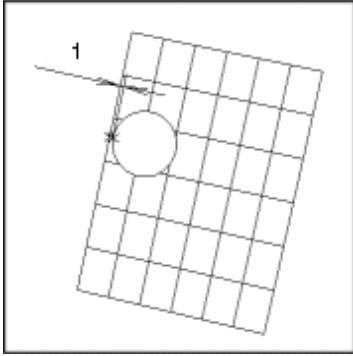

1. TOL

Recommended solution:

Enlarge the space between boundary curves and remove loops. Where necessary, partition faces or consolidate boundary curves.

- **Proximity of Boundary Curve to its Surface** (default check setting: < 0.02 mm) - In bounded surfaces, GeomIntegrityCHECK reports boundary curves with too great a distance to the surface (normal or lateral). It also reports boundary curves that extend beyond the parameter range of the surface.

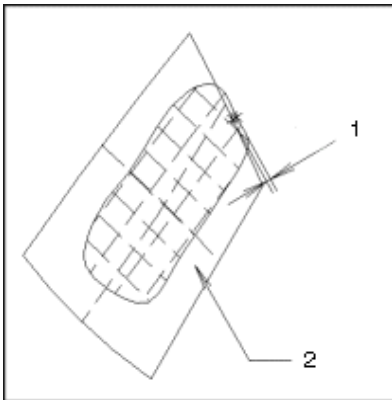

1. TOL

2. Surface

This error would prevent the correct definition of a bounded surface. It would require that the projection on the surface be performed once more in systems or environments of greater exactness.

GeomIntegrityCHECK distributes equidistant points along a bounded curve and projects them on the surface. If the distance from a point on the curve to its projected counterpart on the surface exceeds the configuration specification, the boundary curve is marked. In addition, if a projected point extends beyond the parameter range of the surface, the distance between that point and the original point on the curve is measured, and the curve is marked.

Recommended solution:

Create curves that are always within the range of tolerances of identical elements as sectional curves or projections, or generate new ones where necessary.

- **Parallel Path or Similar Orientation** - GeomIntegrityCHECK reports boundary curves that are not parallel, because they can lead to unwanted self-penetration and face degeneration in some systems.

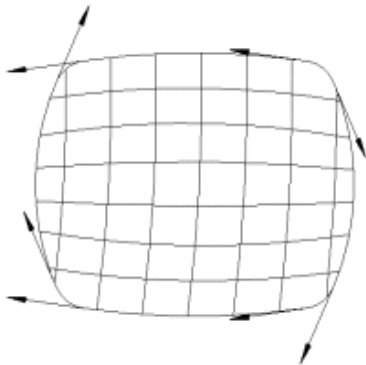

Recommended solution:

Partially reverse the direction of rotation and recreate the bounded surface.

- **Number of Segments in a Boundary Curve** (default check setting: < 2 mm) - GeomIntegrityCHECK reports cases of disproportionately large numbers of segments within a boundary curve.

Such an error raises the risk of tiny elements as well as discontinuity, and it impedes implementation of changes.

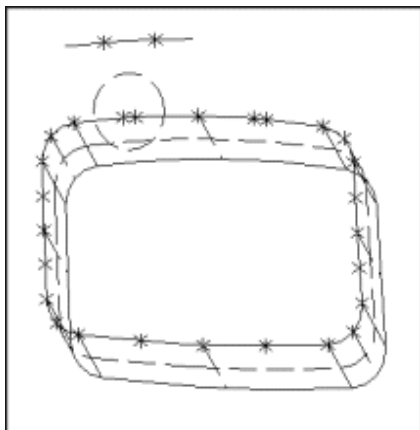

Recommended solution:

Correct or replace boundary curves and recreate the bounded surface with them.

After you have determined all the settings for the **Face** checks, click **OK** to start the checking process, or click **Cancel** to specify new settings.

Topology Checks

Neighboring bounded surfaces, which together form a particular part or a complete surface of an object, are called composite surfaces, surface groups, or topology. Within a topology, special requirements apply regarding the faces in the boundary curves.

When you click the **Topology** tab in the **Geometry CHECK** dialog box, a tabbed page appears. It contains the following checks:

- **Junction or Number of Faces per Edge** (default check setting: < 3) - GeomIntegrityCHECK checks for topological consistency (that is, the explicitness and the unity of surface groups) and absence of junctions. It reports the location of multiple junctions.

GeomIntegrityCHECK locates the absence of junctions by examining the boundary curves of individual faces. A boundary curve may have in a section only one other boundary curve that is completely or partially congruent.

It is important for the topological explicitness of a surface that every inner face edge must have one explicit neighboring face. That is, every inner face cannot have more than one neighboring edge and must be free from bifurcation and junctions. It is however permissible that a face edge borders on several neighboring face edges, one after the other (T-type butt joint).

Recommended solution:

Remove superfluous faces.

- **Orientation of Similar Normals** - GeomIntegrityCHECK checks whether all the normals of neighboring faces in a group have the same orientation. It reports the faces with normals whose orientation differs from the orientation of the majority of normals in the same face.

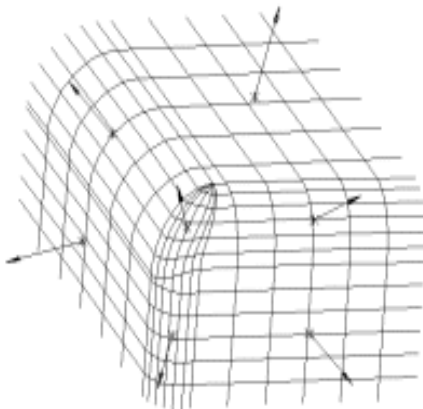

If the definition of the topology element allows the presetting of a particular direction or orientation, this check ascertains whether all the normals comply with the preset orientation or not.

In the case of closed or unified groups, align all normals to the outside (away from the material) or to the inside (toward the material). In the case of open groups, reversal of the minority with a non-compliant orientation is optional.

The orientation of face normals within a topology must be uniform for the determination of the machining direction by milling. The same condition is necessary for hatched depictions and for ascertaining through the geometry the capability for ejecting the part from the tool, or for the definition of the touch direction by measuring.

Recommended solution:

Reverse individual face normals so that all face normals are topologically uniformly oriented away from the material.

- **Knife Edge** (default check setting: > 2) - GeomIntegrityCHECK reports the faces of composite surfaces whose angle between the tangential planes on a common boundary curve (or parts thereof) shows properties of a minute angle of nearly 0 degrees. At the restart points and fulcrums, GeomIntegrityCHECK calculates the angle between the tangential planes. GeomIntegrityCHECK reports all angles that are around 0 degrees.

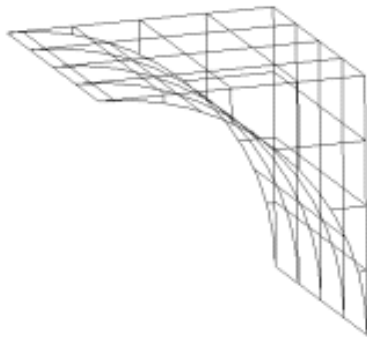

If the angle of the tangential planes between neighboring bounded surfaces on the common edge is too small, sharp edges or recesses occur. Such areas cannot be produced. For example, they occur as a result of the subtraction of a cylinder from a cube.

After you have determined all the settings for the **Topology** checks, click **OK** to start the checking process, or click **Cancel** to specify new settings.

Solids Checks

When you click the **Solids** tab in the **Geometry CHECK** dialog box, a tabbed page appears. It contains the following checks:

- **Distance to Vertex Edge** (default check setting: < 0.02 mm) - GeomIntegrityCHECK reports the vertex and the edge in a solid if the distance between the two elements exceeds the tolerance value specified in your configuration file.

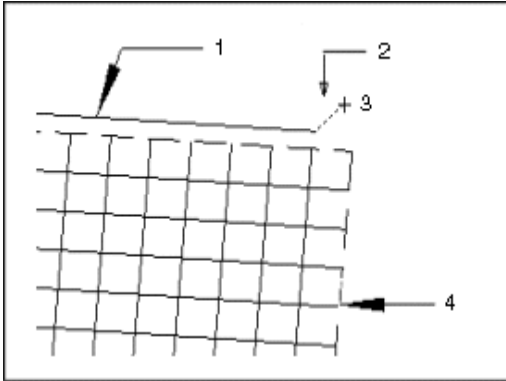

1. Edge
2. Vertex to Edge Gap
3. Vertex
4. Face

The point that belongs to a vertex must lie within the configured tolerance on the curve which is a part of the corresponding edge. If the distance between the point and the curve exceeds the tolerance value, the solid is defective.

Recommended solution:

Project the point onto the curve. Otherwise, generate a new one.

Note: In a transfer of solids through neutral interfaces (for example, STEP), a boundary representation (B-rep) is transferred. This is the description of the solid through its bounded surfaces (faces), which represent the direct surface. These faces form the foundation for surfaces and boundary curves.

Hence, for solids, the quality criteria for a closed (unified) group of faces are also applicable. The criteria for surfaces, bounded surfaces (faces), and topologies are correspondingly applicable to the bounded surfaces of a solid, including its surfaces and boundary curves, that is, the distance from the bounded curves to the surface.

- **Distance to Vertex Face** (default check setting: < 0.02 mm) -
GeomIntegrityCHECK reports the vertex and the face in a solid if the distance between the two elements exceeds the tolerance value specified in your configuration file.

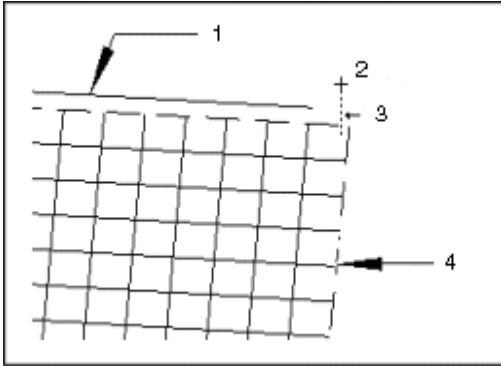

1. Edge
2. Vertex
3. Vertex to Face Gap
4. Face

The point on a vertex must lie within the configured tolerance on the associated bounded surface. If the distance between the point and the face exceeds this value, the solid is defective.

Recommended solution:

Project the point on the face, if possible. Otherwise, generate a new one.

- **Deletion of History** - GeomIntegrityCHECK reports the B-reps in a solid if they have been imported into the existing model.
- **Auxiliary Geometry** - GeomIntegrityCHECK reports the solid elements that are hidden from view (for example, cut-off component part areas and dead branches).

In addition, it reports added material in component part areas that are already filled with material, without altering the component part in any way (for example, addition of a ball or sphere to a rectangular solid).

GeomIntegrityCHECK also reports geometrical elements that have no logical relationship to the given solid.

- **Cavities** - GeomIntegrityCHECK reports solids that are fully contained in another solid and are to be fully subtracted from.
- **Multi-Body Solids** - GeomIntegrityCHECK reports solids that contain two volumes that do not touch each other. It considers the two volumes to be separate bodies, which is unacceptable in a single solid.
- **Multi-Solid Parts** - In an assembly environment, there is generally only one solid in one part. If there is more than one solid in a model, GeomIntegrityCHECK reports them as separate solids.

After you have determined all the settings for the **Solids** checks, click **OK** to start the checking process, or click **Cancel** to specify new settings.

Metrics Tool

About the Web-Enabled ModelCHECK Metrics Tool

ModelCHECK provides a Web-based metrics tool that enables you to graphically represent ModelCHECK results. This metrics tool utilizes the information saved in the ModelCHECK metrics files after a session of ModelCHECK to create its database for the generation of graphs and reports. These graphs are generated at realtime for all the operating modes of ModelCHECK and are analytical by nature.

The graphs and reports that this tool generates provide a picture of the engineering process and generate a high-level picture of the company's design trends. They also help identify overall issues and help resolve them with adequate training, and justify additional training requirements in specific areas. Additionally, they help enforce company standards and best practices to meet the demands of better data quality.

The following are some of the information that the tool displays as graphs:

- The errors and warnings recorded against users or groups
- The distribution of the errors and warnings
- The number of ModelCHECK initializations
- A report of the failed checks
- The experience levels of ModelCHECK users
- The total investment on training

In addition, you can use this tool to perform the following functions:

- Access the ModelCHECK and the training databases
- Define a groups of users based on factors such as active projects and functional areas
- Create check sets and map them against the users or groups
- Check and monitor the experience levels of users
- Monitor the quality of models for specific ModelCHECK failures
- Evaluate the progress of the users or groups and the company against the company goals
- View the overall company status and the status of the models, at a glance
- Define the company's quality goals based on the checks, errors, and warnings

About the Task Sets and Functions

The metrics tool consists of the following task sets:

- **Overview** - Displays general and customized information and the overall quality status of the company.
- **Administration** - Enables the creation of check sets, the definition of users and groups, maps check sets against users, and monitors user experience and the quality goals of the company.
- **Analysis-Graphs** - Enables the generation of the graphs and reports for errors and warnings, the check distribution, ModelCHECK initializations, user experience, and investments made on training.
- **Preferences** - Provides options with which you can customize the information that you want to display on the **Overview** page. It also sets the defaults for the other tabbed pages.
- **Search** - Creates a report of the failed checks.

About the Setup of the ModelCHECK Metrics Tool

You can install the metrics tool on Windows, UNIX, and Linux and view ModelCHECK results in the Internet Explorer version 6.0 and Mozilla version 1.4.1 and above browsers. You do not require a separate license to use this tool. Refer to the *Wildfire Installation Guide* for details on the installation.

You are not required to run ModelCHECK to access or use this tool. After the installation and deployment of the metrics tool, you can invoke the metrics tool from the Internet Explorer or the Mozilla browser. You must specify the name of the server on which the metrics tool is deployed along with the port and `metrics_tool` as the name of the tool in the browser window. The tool opens in the browser window displaying the **Overview** page with general information for which you have set preferences as part of the customization of this page.

Displaying Graphs and Reports

The Web-based metrics tool utilizes the information saved in the ModelCHECK metrics files after every session of ModelCHECK to create its own database for the graphs and reports it generates. These graphs and reports are generated for all the operating modes of ModelCHECK, such as Interactive, Regenerate, Save, MC_regen, and Batch, in the image directory as `.png` image files. The path to the image directory must be specified in the relevant `new_admin.xml` and `new_admin.war` context configuration files. These context files are required for the deployment of the tool.

Browser plugins, such as the QuickTime plugin, is a browser configuration requirement for the display of graphs in the Internet Explorer version 6.0 or the Mozilla version 1.4.1 and above browser. These browser plugins are generally inbuilt. If not, access the QuickTime plug in from <http://www.apple.com/quicktime/download/>.

Setting Parameters in the Context Files

Make sure that you have set the following parameters in the `new_admin.xml` configuration file that is required for the deployment of the metrics tool:

- `dbname` - The name of the database
- `dbtype` - The type of database used, such as Oracle or MSAccess
- `adminserver` - The name of the machine that is the server for the metrics tool
- `adminport` - The port number of the machine that is the server for the metrics tool
- `imagedir` - The location or path of the Image Directory
- `imagedirLink` - The link to the Image Directory that stores the images of the graphs and reports in the metrics tool
- `collect_mc_db_interval` - The time taken, in hours, for the automatic update of the ModelCHECK database. The minimum is an hour.

About the Database for the Metrics Tool

The Web-based metrics tool generates graphs and reports based on the information saved as metrics files in the ModelCHECK database after every session of ModelCHECK. It uses the ModelCHECK results stored in the metrics files with a `.txt` extension to create additional databases.

You must create the following database tables that initially consist of empty columns and rows:

- `mc_database`
- `user_database`
- `trng_database`

Note: Use Oracle or Microsoft Access to create the database tables.

Additionally, you must also create a database table with empty columns and rows for the processed files, named `processedfiles`. These processed files ensure the accurate entry of data from the metrics files in the database tables, avoiding duplicate entries and also making sure that the data in the database tables are up-to-date.

You can use a command line utility, built into `create_mcadadmin_db.jar`, to fill the database tables with information from the `.txt` metrics files. The metrics tool reads and interprets the data in the metrics files and automatically updates the relevant database tables. Each row of every metrics file is appropriately included in the corresponding database tables. The names of the `.txt` metrics files and the date of inclusion of their contents in the relevant database tables are also simultaneously written in the `processedfiles` database table so that information is not repeated in the database tables. With subsequent use of the metrics tool, the metrics database is automatically updated with a frequency that you can configure.

The graphs and reports generated from the **Overview**, **Administration**, and **Analysis-Graphs** tabbed pages of the metrics tool depend on the data that is stored in these databases. The preferences that you set for the display of graphs and reports on the **Overview** page also depend on the information in these database files.

To Update the Database Tables Using create_mcadadmin_db.jar

1. Set the CLASSPATH environment variable to the path of the create_mcadadmin_db.jar file as shown below.

```
set CLASSPATH=<path to file_1>;<path to file_2> (Windows) or
```

```
setenv CLASSPATH .:<path to file_1>:<path to file_2> (UNIX)
```

For example:

- o On Windows, use the following command:

```
set
CLASSPATH=d:\wildfire\modchk\mc_admin\new_admin\dist\create_mcad
min_db.jar;
d:\wildfire\modchk\mc_admin\new_admin\dist\classes111.jar
```

- o On UNIX, use the following command:

```
setenv
CLASSPATH ./usr2/wildfire/classes111.jar:/usr2/wildfire/create_
mcadmin_db.jar
```

Note: The classes111.jar file is required to manually execute the create_mcadadmin_db.jar utility when an Oracle database is used.

2. Update the user_database table using the following command:

```
<java home> <class name to update user_database> <database type>
<database driver> <database url> <username> <password> <path to CSV
file>
```

where the CSV file has the following sample information and structure:

```
usr1,Devid,Boon,K,CADQA,23453,3380,09-04-
2000,QA,d:\projects\devid
usr2,Alan,Donald,Y,CADDESIGN,23367,3181,10-02-
2000,DESIGN,d:\projects\alan
```

Note: You must manually execute the above command. The command updates the user_database table with the information from the CSV file.

For example:

- o For an Oracle database, use the following command:

```
$JAVA_HOME/bin/java com.ptc.usersdb.McUsersCreator oracle
oracle.jdbc.driver.OracleDriver
```

```
jdbc:oracle:thin:@machine1:1521:admin user1 userpass
d:\wildfire\user.txt
```

- o For a Microsoft Access database, use the following command:

```
$JAVA_HOME/bin/java com.ptc.usersdb.McUsersCreator msaccess
sun.jdbc.odbc.JdbcOdbcDriver jdbc:odbc:admin user1 userpass
d:\wildfire\user.txt
```

A sample `user_database` table is shown below:

USERID	LASTNAME	FIRSTNAME	MIDDLENAME	GROUP_B	PHONE	EXTENSION	PROEDATE	INFO1	LOCATION
bdevid	Devid	Boon	K	CADQA	23453	3380	04-SEP-05	QA	d:\projects\devid
dalan	Alan	Donald	Y	CADDESIGN	23367	3181	02-OCT-00	DESIGN	d:\projects\alan

3. Update the `mc_database` table using the following command:

```
<java home> <class name to update mc_database> <database type>
<database driver> <database url> <username> <password>
```

Note:

- o The `mc_database` table is automatically updated when the `new_admin.war` file is deployed. See the *Pro/ENGINEER Installation and Administration Guide* for details. You can also manually execute the above command if required. Either way, the `mc_database` table is updated with information from all the metrics files at the locations specified in the `user_database` table.
- o As each metrics file is processed, its name is added to the `processedfiles` table.

For example:

- o For an Oracle database, use the following command:

```
$JAVA_HOME/bin/java com.ptc.metricsdb.McMetricsCollector oracle
oracle.jdbc.driver.OracleDriver
jdbc:oracle:thin:@machine1:1521:admin user1 userpass
```

- o For a Microsoft Access database, use the following command:

```
$JAVA_HOME/bin/java com.ptc.metricsdb.McMetricsCollector
msaccess sun.jdbc.odbc.JdbcOdbcDriver jdbc:odbc:admin user1
userpass
```

A sample `mc_database` table is shown below:

USERID	DATE_N_TI	MDLNAME	MDLTY	CHECKTAG	CHKSTAT	INFO1	MCMODE
devid	18-JUL-04	RIM	PRT	SUP_FEATURES	WRN	2	Interactive
devid	18-JUL-04	RIM	PRT	UNITS_LENGTH	OK	INCH	Interactive
devid	18-JUL-04	RIM	PRT	UNITS_MASS	OK	POUND	Interactive
devid	21-OCT-04	PRT0001	PRT	mc_initialize	1	0	Interactive
devid	21-OCT-04	PRT0001	PRT	PARAMCHECK	OK	0	Interactive
alan	12-APR-05	02J_301_107_C-ROH_KUPPGEH	PRT	MODEL_NAME	OK	0	MC_regen
alan	12-APR-05	02J_301_107_C-ROH_KUPPGEH	PRT	PARAMCHECK	WRN	9	MC_regen
alan	12-APR-05	02J_301_107_C-ROH_KUPPGEH	PRT	PLANE_CHILD	OK	0	MC_regen

A sample `processedfiles` table is shown below:

FILENAME	MERGEDATE
devid_200407180949.txt	19-APR-06
devid_200410211010.txt	19-APR-06
alan_200503221503.txt	19-APR-06
alan_200504121146.txt	19-APR-06

About the Metrics Database

The generations of graphs and reports that are analytical by nature, such as the ModelCHECK data that is displayed in a tabular format when you click **Administration > ModelCHECK Data** in the metrics tool, are based on the metrics database or the `mc_database`.

The following is the data that is stored in the `mc_database` table:

- User ID (`UserId`)
- Date and time (`date_n_time DATE`)
- Model name (`mdlname`)
- Model type (`mdltype`)
- Check type (`checktag`)
- Check status (`chkstat`)
- Information (`info1`)
- ModelCHECK mode (`mcmode`)

About the Training Database

The generation of graphs and reports related to the training of ModelCHECK users, such as graph on the total investment on training, are based on the `trng_database`.

The following is the data that is stored in the `trng_database` table:

- The user ID (`UserId`)
- The course ID (`CourseId`)
- The course name (`CourseName`)
- The course date (`CourseDate DATE`)
- The provider of the course (`provider`)
- The instructor's name (`instructor`)
- The location of the course (`location`)
- The total investment on the training (`cost`)
- The grade achieved (`grade`)

About the User Database

The `user_database` is the basis for the generation of graphs and reports that are related to the ModelCHECK users, such as the graph on the experience levels of users. The following is the data that is stored in the `user_database` table:

- The user ID (`UserId`)
- The last name of the ModelCHECK user (`lastname`)
- The first name of the ModelCHECK user (`firstname`)
- The middle name of the ModelCHECK user (`middlename`)
- The group to which the user belongs (`group_b`)
- The telephone number of the ModelCHECK user (`phone`)
- The extension number of the ModelCHECK user's telephone (`extension`)
- The date when the user ran ModelCHECK for which the metrics files were created (`proedate DATE`)
- Information (`info1`)
- The location of the `mc_metrics` files (`location`)

Troubleshooting Tips for the Display of Graphs and Tables

While using the Web-based metrics tool, you are likely to encounter problems related to the display of the graphs and reports in the Internet Explorer or the Mozilla browser. The following are some of the causes and the corresponding troubleshooting tips:

- The path to the `Image Directory` is not specified in the `new_admin.xml` configuration file. If specified, it may be incorrect.

Tip: Verify the location of the `Image Directory` and the path specified in the `new_admin.xml` configuration file. If found incorrect in the `new_admin.xml` file, specify the correct path, and deploy the Metrics tool again.
- The Apache Web server is not up and running or is not available.

Tip: Verify if the Apache Web server is up and running and start the Apache Web server, if required. Before starting the server, make sure that the location of the `Image Directory` is valid and exists.
- The `DocumentRoot` path in `Apache\conf\httpd.conf` file is not set properly.

Tip: Specify the `DocumentRoot` path correctly in the `Apache\conf\httpd.conf` file.

If problem persists, specify the `Image Directory` location the same as the `DocumentRoot` path.
- The metrics tool displays the `connection pool exhausted` error.

Tip: Check the values specified for **Max. Active Connections**, **Max. Idle Connections**, and **Max. Wait for Connection** in the **Data Sources** page of the Tomcat Web Server Administration Tool. Increase the value of **Max. Active Connections** and **Max. Idle Connections** and start the metrics tool again.

Note: Make sure that you click **Commit Changes** on the Tomcat Web Server Administration Tool when you edit information in the **Data Sources** page.

- The information specified in the **Data Sources** page of the Tomcat Web Server Administration Tool does not match the information specified in the `new_admin.xml` configuration file.

Tip: Verify if there is a mismatch of information in the **Data Sources** page and the `new_admin.xml` configuration file. In case of a mismatch, ensure that the information specified in the `new_admin.xml` configuration file matches with the information that you have specified in the **Data Sources** page.

- The location of the `Image Directory` specified in the `new_admin.xml` configuration file does not match the location specified in the `DocumentRoot` path of the `Apache\conf\httpd.conf` file.

Tip: Ensure that the `Imagedir` path specified in the `new_admin.xml` configuration file is the same as the `DocumentRoot` path in the `Apache\conf\httpd.conf` file.

- The parameters related to the display of graphics are not set in the `new_admin.xml` configuration file.

Tip: Check the `new_admin.xml` configuration file and set the following parameters and their corresponding values:

- `dbname` - The name of the database.
- `dbtype` - The type of database used, such as Oracle or Microsoft Access.
- `imagedir` - The location or path of the `Image Directory`.
- `imagedirLink` - The link to the `Image Directory` that stores the images of the graphs and reports in the metrics tool.

Overview

About the Overview Page



The **Overview** page is the introduction to the metrics tool. It displays customized information and depends on the preferences you have set in the **Preferences** page.

The **Overview** page consists of the display of a minimum of two or a maximum of five graphical representations of the following ModelCHECK results:

- The number of errors or warnings against users or groups
- The number of ModelCHECK initializations
- The most and the least frequently failed checks

- The experience levels of users
- The total investment on training for a user or for a particular course

You can set the preference for the type of graph to be displayed on the **Overview** page as bar, column, line, or pie. These graphs are generated at realtime in the image directory for all the operating modes of ModelCHECK, such as the Interactive, Regenerate, Save, MC_regen, and Batch modes. In addition, the status indicator () on the **Overview** page also displays the overall quality status of all models as green, yellow, and red, indicating low medium, and high degrees of quality, respectively.

If you change the settings on the **Preferences** page, click **Refresh Overview** () on the **Overview** page to update the **Overview** page for the corresponding change in the preference. You can click  to generate a HTML report of the data displayed on the **Overview** page and send this HTML report to recipients on the mailing list that you have configured on the **Preferences** page.

Performing Administration Functions

About the Administration Functions that You Can Perform

You can perform the following tasks that are administrative in nature:

- Map predefined check sets against a group
- View ModelCHECK data as in a database
- Access the training database
- Create critical check sets
- Check the experience level of the users
- Define quality goals for the company

You can add users or define a group of users accessing the database that stores the user IDs and group names, based on factors such as, active projects, functional areas, and so on. Alternatively, you can use a text file with comma-separated usernames.

With users and groups defined, you can define critical checks sets for the users or groups, map these check sets against the users or groups, and highlight the errors and warnings against the checks to be monitored.

You can access the training database to check and monitor the experience levels of users. You can also define the company's quality goals based on the checks and errors and warnings, since a specific date and that are acceptable and the overall status of models.

To Define a Critical Check Set

1. Open the ModelCHECK metrics tool in the Internet Explorer or the Mozilla browser.
2. Click **Administration**.
3. Click **Critical Check sets** on the **Administration** page to define a critical check set.
4. In the **Available Checks** list, scroll the list to search for specific checks and select multiple checks.
5. Use the forward button to include the checks you have selected in the **Selected Checks** list. You can use the reverse button to move a selected check back to the **Available Checks** list if you do not want to include that check in the check set that you are defining.
6. Edit the checklist using the list in **Edit Checkset**.
7. Click **Create** against **New Check Set** to define a new check set with checks.
8. Click **Update Checkset** to regenerate the list with the edited changes. If you have created a new check set, it is added against the group that you have specified and is mapped to the group.

To Specify a Check Set for a Group

1. Open the ModelCHECK metrics tool in the Internet Explorer or the Mozilla browser.
2. Click **Administration**.
3. Click **Group**.
4. Select a group name from the **Group Name** list.
5. Select a check set from the **Checkset Name** list. Select **Feature-checks** or **All-checks**.
6. Click **Update** to map the selected check set to the selected group.

To View ModelCHECK Data

1. Open the ModelCHECK metrics tool in the Internet Explorer or the Mozilla browser.
2. Click **Administration**.
3. Click the **ModelCHECK Data** tab. A table, similar to a database table, is displayed with the following information:
 - **UserId** - The user against whom the check was performed.
 - **Date/Time** - The date and time when the check was performed.
 - **Model Name** - The name of the part or assembly.
 - **Model Type** - The type of the model, whether a part, assembly, or drawing.

- **Check Name** - The name of the check performed.
 - **Check Status** - The category of the check, whether an error or a warning.
 - **Check Information** - The number of errors or warnings.
 - **ModelCHECK Mode** - The operating mode of ModelCHECK, whether Interactive, Regenerate, MC_regen, Save, or Batch, in which the check was performed.
4. Click **Update** to update this page with changes that have occurred at the database level.

To View the Training Database

1. Open the ModelCHECK metrics tool in the Internet Explorer or the Mozilla browser.
2. Click **Administration**.
3. Click the **Training Data** tab. A database table is displayed with the following information:
 - **UserId** - The user whose training details are displayed.
 - **Course Identification** - The course identified.
 - **Course Name** - The name of the course.
 - **Course Date** - The date and time when the course was conducted.
 - **Provider** - The provider of the course.
 - **Instructor's Name** - The instructor's name.
 - **Location** - The geographic location where the course was conducted.
 - **Cost** - The cost involved in dollars to conduct the course.
 - **Grade** - The grade indicating the level of proficiency attained by the user.
4. Click **Update** to update this page with changes that have occurred at the database level and the graph on the total investment on training for a user or for a particular course displayed on the **Overview** page.

To View the Experience Level of a User

1. Open the ModelCHECK metrics tool in the Internet Explorer or the Mozilla browser.
2. Click **Administration**.
3. Click the **Experience level** tab.
4. Specify a date in the MM/DD/YYYY format in **From Date (MM/DD/YYYY)** to specify the duration of the check as the period between the date specified and the current date when the check is being performed.

5. Specify the number of errors and warnings in the **Yellow** and **Green** status fields, as is relevant.
6. Click **Update** to update the status in the status indicator and the graph on the user experience, displayed on the **Overview** page.

To Set the Quality Goals of the Company

1. Open the ModelCHECK metrics tool in the Internet Explorer or the Mozilla browser.
2. Click **Administration**.
3. Click the **Quality Goals** tab.
4. Specify a date in the MM/DD/YYYY format in **From Date (MM/DD/YYYY)** to specify the date from when you are defining the quality goals of the company.
5. Specify the total number of errors and warnings in the **Yellow** and **Green** status fields, as is relevant.
6. Click **Update** to apply the changes to the status indicator on the **Overview** page that displays the overall quality status of all models.

Generating Analysis-Graphs

About Generating and Displaying Analysis Graphs

Graphs are generated in the image directory as image files with the .png extension and are displayed on the **Overview** and **Analysis-Graphs** pages. The information that the graphs represent and their type depend on the data that is stored in the databases and the preferences that you have set.

You can generate graphs from **Analysis-Graphs** for the following data:

- The number of errors or warnings
- The most frequently and the least frequently passed checks
- The number of ModelCHECK initializations
- The experience levels of ModelCHECK users
- The investment on training for users or course

You can display these graphs on the **Overview** and **Analysis-Graphs** pages. In addition to setting preferences for the display of all or some of the above data as graphs, you can also set preferences for the generation of the following types of graphs:

- Bar
- Column

- Line
- Pie

Note: The Pie graph also shows the results in percentage.

If the graphs are relatively big and do not fit the browser window, you can click  to separately display the graph in an additional window.

To Create a Graph on Errors or Warnings

1. Open the ModelCHECK metrics tool in the Internet Explorer or the Mozilla browser.
2. Click the **Analysis-Graphs** tab.
3. Select any one of the following from the **View By** list to display a graph of the errors and warnings for the selected item on the list:
 - **User Id** - The ModelCHECK users
 - **Month** - The months
 - **Year** - The years
 - **Date** - The dates
 - **Check** - The check names
 - **Mode** - The ModelCHECK modes
4. Select the type of graph as **Bar**, **Column**, **Pie**, or **Line** from the **Graph Type** list.
5. Click **Show Graph**. A graph with errors or warnings against specific user IDs, months, years, days, check names, or ModelCHECK modes is displayed in the browser.

Example: A Graph on Errors and Warnings

The following is a pie graph on the errors and warnings against specific checks that is displayed on the **Overview** page. This graph is generated from **Analysis-Graphs > Error/Warning** on the metrics tool.

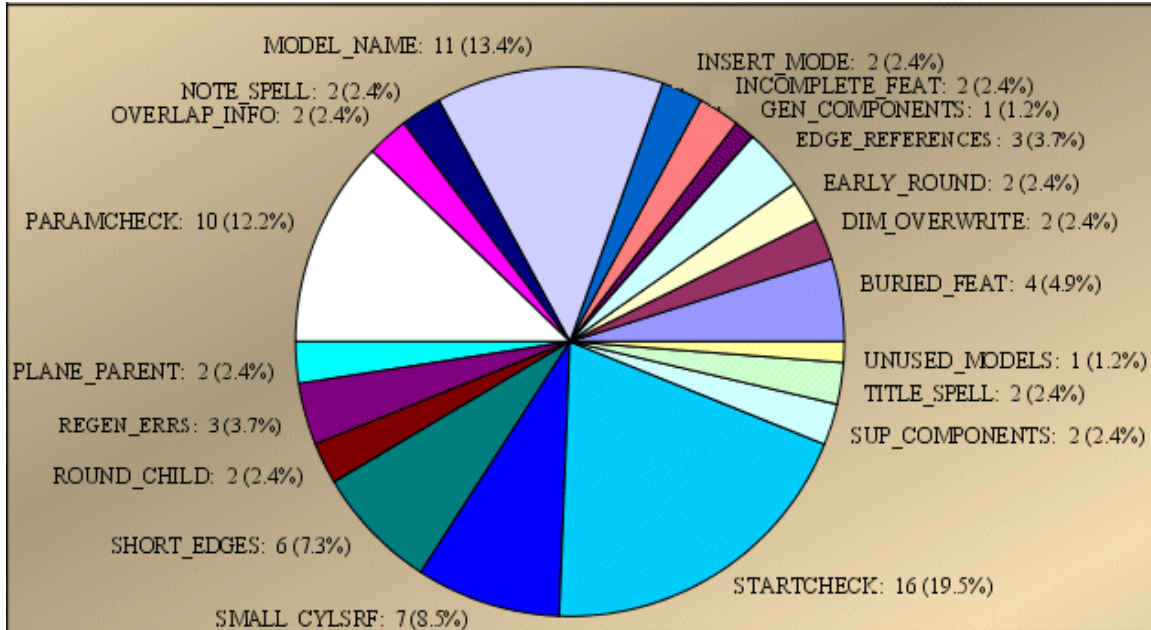

Note: The errors and warnings are also represented as a percentage because the graph is of the pie type.

To Display a Graph of the Most and Least Frequently Passed Checks

1. Open the ModelCHECK metrics tool in the Internet Explorer or the Mozilla browser.
2. Click **Analysis-Graphs**.
3. Click **Check Distribution**.
4. Select **Most Frequent Passed Checks** or **Least Frequent Passed Checks** from the **View By** list.
5. Select the number of checks in increments of five, in the range of 5 through 15, from the **Amount** list.
6. Select the type of graph as **Bar**, **Column**, **Pie**, or **Line** from the **Graph Type** list.
7. Click **Show Graph**. A graph of the least or most frequently passed checks for the number of checks specified against the passing frequency is displayed.

Example: A Graph on the Least Frequently Passed Checks

The following is a column graph on five of the least frequently passed checks against the passing frequency that is displayed on the **Overview** page. This graph is generated from **Analysis-Graphs > Check Distribution** on the metrics tool.

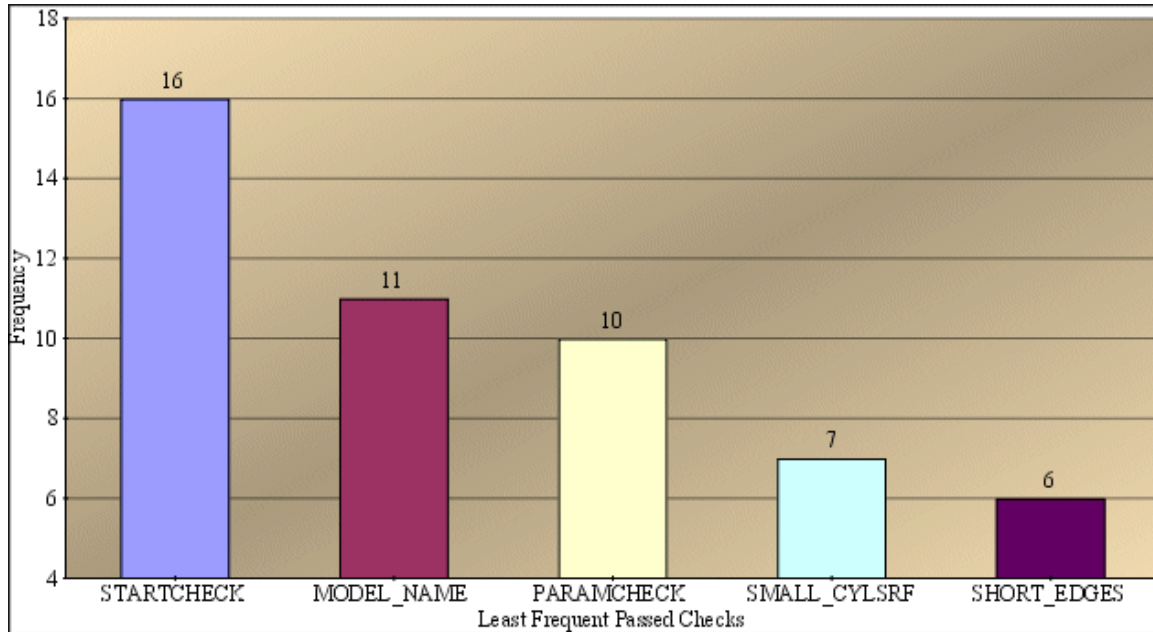

To Display a Graph for the Number of ModelCHECK Runs

1. Open the ModelCHECK metrics tool in the Internet Explorer or the Mozilla browser.
2. Click **Analysis-Graphs**.
3. Click **Usage**.
4. Select any one of the following from the **View By** list to display a graph of the number of ModelCHECK usage or initializations for the selected item on the list:
 - **User Id** - The ModelCHECK users
 - **Month** - The months
 - **Year** - The years
 - **Date** - The dates
 - **Mode** - The ModelCHECK modes
5. Select the type of graph as **Bar**, **Column**, **Pie**, or **Line** from the **Graph Type** list.
6. Click **Show Graph**. A graph with the number of ModelCHECK initializations is displayed against specific user IDs, months, years, day, or ModelCHECK modes.

To Display a Graph on User Experience

1. Open the ModelCHECK metrics tool in the Internet Explorer or the Mozilla browser.
2. Click **Analysis-Graphs > User Experience**.
3. Select **Days, Hours, or Weeks** from the **View By** list to display the experience in days, hours, or weeks, respectively.
4. Select a ModelCHECK user from the **User** list.
5. Select the type of graph as **Bar, Column, Pie, or Line** from the **Graph Type** list.
6. Click **Show Graph**. A graph with user experience against days, hours, or weeks is created and displayed in the browser. **Status** indicates the experience level as red, yellow, or green. You can interpret this indication as experience level that is of a low, medium, or high degree, respectively.

Example: A Graph on User Experience

The following is a line graph on the experience of ModelCHECK users in days that is generated from **Analysis-Graphs > User Experience** on the metrics tool.

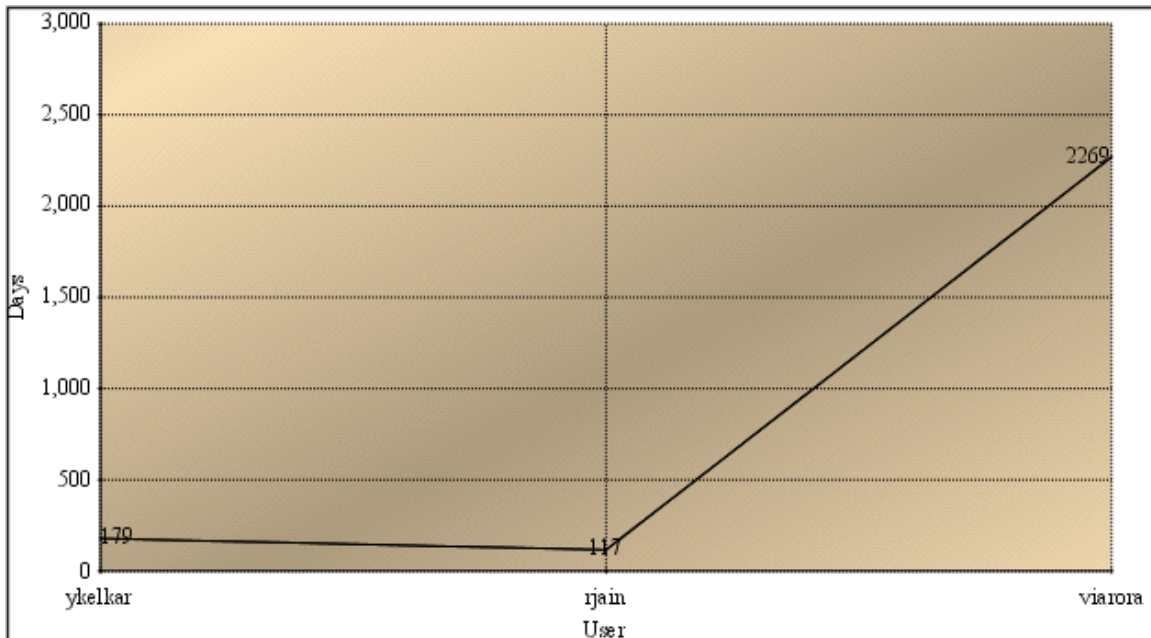

To Create a Graph on Training Costs of Users or a Course

1. Open the ModelCHECK Metrics tool in the Internet Explorer or the Mozilla browser.
2. Click **Analysis-Graphs > Training**.
3. Select **User ID** or **Course** from the **View By** list to display the expenses incurred for a course or specific ModelCHECK users.

4. Select the type of graph as **Bar**, **Column**, **Pie**, or **Line** from the **Graph Type** list.
5. Click **Show Graph**. A graph with investments involved in the training of users or by course is created and displayed in the browser.

Example: A Graph on Training Investment

The following is a bar graph on the investments made in training by course that is generated from **Analysis-Graphs > Training** on the metrics tool.

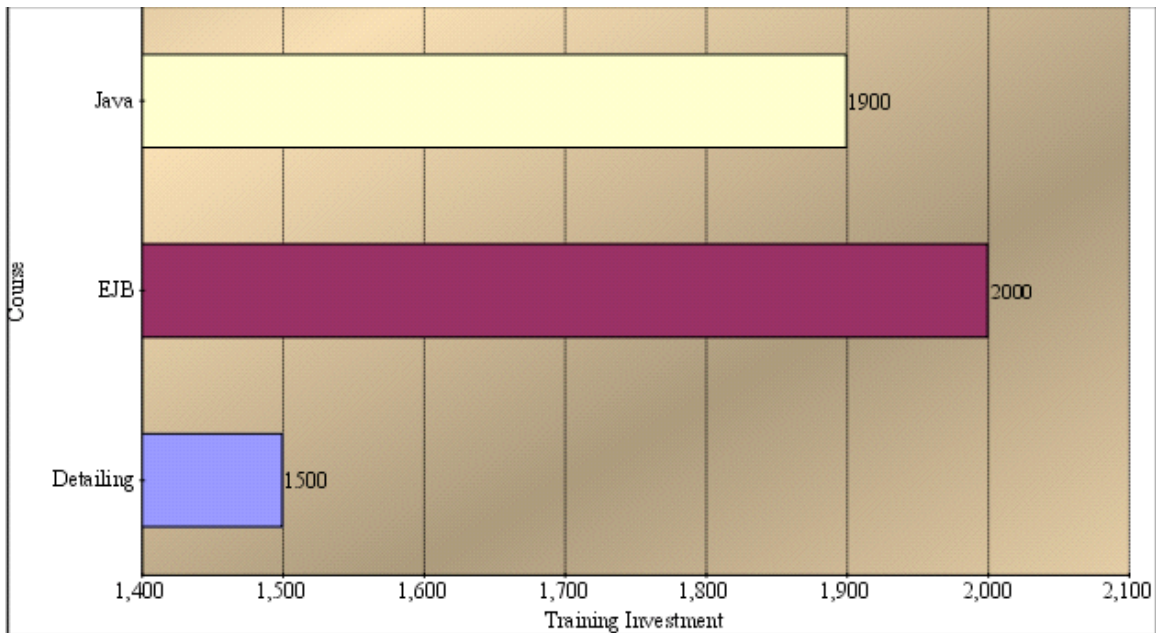

Setting Preferences

About Setting Preferences

You must set the preferences on the **Preferences** page to customize the manner of display of information on the **Overview** and **Analysis-Graphs** pages. The preferences that are set are also applied to other task sets of the Metrics tool. They are the default settings, but you can make alternative selections to override the set preferences.

You can set the preferences for the following information that is displayed on the **Overview** page:

- The users or groups against which the checks are to be performed.
- The nature of the checks as warnings or errors, or both.
- The model names and types for which the checks are performed.
- The type of graphs to be displayed, whether bar, column, pie, or line.

- The information, such as error or warnings, ModelCHECK initializations, check distribution, user experience, or training expenses, that you want displayed as a graph on the **Overview** page.
- The number of graphs that you want to display.
- The generation of reports for all or some of the graphs, including the overall quality status of the company, that are displayed on the **Overview** page.
- Configuration of a mailing list of recipients for the reports.

You can set all or some of the following preferences for the display of graphs and the generation of reports on the **Overview** page:

- The number of errors or warnings against users or groups.
- The number of ModelCHECK initializations.
- The most and the least frequently passed checks
- The experience levels of users.
- The investments on training of users or course.

You must click **Refresh Overview** () on the **Overview** page after you have set the preferences on the **Preferences** page. The preferences that are set on the **Preferences** page also set the default values for the tabbed pages of **Analysis-Graphs**.

To Set Data Filters for the Metrics Analysis

1. Open the ModelCHECK metrics tool in the Internet Explorer or the Mozilla browser.
2. Click **Preferences**.
3. Click **Data Filters**.
4. Select a group from the **Group** list on the **Data Filters** page to specify the group.
5. Specify the **Check Status** as **Error**, **Warning**, or **Both** error and warning, or **OK**.
6. Type the name of the model in **Model Name**.
7. Specify the **Model Type** as **All**, **Part**, **Assembly**, or **Drawing**.
8. Specify the **Date** and **Time** in the boxes under **From** and **To** as the duration for the check of the model.
9. Click **Update** to apply the preferences that you have set.
10. If you have changed the preferences for the information that is displayed on the **Overview** page, click **Overview** on the ModelCHECK metrics tool and click **Refresh Overview**.

To Set Preferences for the Display of Graphs and Tables

1. Open the ModelCHECK metrics tool in the Internet Explorer or the Mozilla browser.
2. Click the **Preferences** tab.
3. Click **Graph/Table Settings**.
4. Set the following preferences for the **Error/Warning** graph on the **Overview** page:
 - Select the type of graph to be displayed as **Bar, Column, Pie, or Line** from the **Default Style** list.
 - Select **User Id, Month, Year, Date, Check, or Mode** from the **View By** list to generate the Error/Warning graph for a user, month, year, day, a specific check, or a ModelCHECK mode, respectively.
5. Set the following preferences for the **MC Usage** graph on the **Overview** page:
 - Select the type of graph to be displayed as **Bar, Column, Pie, or Line** from the **Default Style** list.
 - Select **User Id, Month, Year, Date, or Mode** from the **View By** list to generate the graph on the number of ModelCHECK initializations for a user, month, year, day, a specific check, or a ModelCHECK mode, respectively.
6. Set the following preferences for the **Check Distribution** graph on the **Overview** page:
 - Select the type of graph as **Bar, Column, Pie, or Line** from the **Default Style** list.
 - Select **Most Frequent Passed Checks** or **Least Frequent Passed Checks**.
 - Select the number of checks in increments of five, in the range of 5 through 15, from the **Amount** list.
7. Set the following preferences for the **User Experience** graph on the **Overview** page:
 - Select the type of graph as **Bar, Column, Pie, or Line** from the **Default Style** list.
 - Select **Days, Hours, or Weeks** for which you want to display the user experience.
8. Set the following preferences for the **Training** graph on the **Overview** page:
 - Select the type of graph as **Bar, Column, Pie, or Line** from the **Default Style** list.
 - Select **Course** or **User Id** for which you want to display the training investment graph.

9. Click **Update** to apply the preference settings.
10. If you have changed the preferences for the graphs that are displayed on the **Overview** page, click **Overview** on the ModelCHECK metrics tool and click **Refresh Overview**.

To Set Preferences for the Creation of Reports

1. Open the ModelCHECK metrics tool in the Internet Explorer or the Mozilla browser.
2. Click the **Preferences** tab.
3. Click **Reports**.
4. Select one or more of the following options to set the preference to generate HTML reports of the corresponding graphs that are displayed on the **Overview** page:
 - **Warning/Error Graph** - Generates a report of the graph on the number of errors or warnings.
 - **Usage Graph** - Generates a report of the graph on the number of ModelCHECK initializations.
 - **Distribution Graph** - Generates a report of the graph on the most and the least frequently failed checks.
 - **Experience Graph** - Generates a report of the graph on the experience levels of users.
 - **Training Graph** - Generates a report of the graph on the investment on training.
 - **Company Quality Status** - Generates a report of the overall quality status of all models in the company as displayed by the status indicator on the **Overview** page.
5. Specify the name of the mail server in the **Mail Server** box.
6. Specify your e-mail account in the **Mail Server Account** box.
7. Type the user IDs of the recipients of the reports generated, all comma-separated, in the **Recipients** box.
8. Click **Update** to apply the preference settings.

To generate reports according to the preferences you have set, click  on the **Overview** page. The reports of the graphs that you have selected as preferences are generated in the working directory and sent to recipients on the mailing list that you have configured on the **Preferences** page.

Searching for Failed Checks

To Search for Failed Checks

1. Open the ModelCHECK metrics tool in the Internet Explorer or the Mozilla browser.
2. Click **Search**. The **Failed Checks** page is displayed.
3. Select one or more check names from the list.
4. Select **Error** or **Warning** in the adjacent list box.
5. Click **Show Failed Models**. The following results are displayed in a tabular format:
 - **UserId** - The ModelCHECK users working on the models that have failed the selected checks.
 - **Date/Time** - The date and time when the models failed the checks.
 - **Model Name** - The names of the models that have failed the checks.
 - **Model Type** - The model type of the models that have failed the checks, whether assembly, part or drawing.
 - **Check Name** - The names of the checks for which the models indicate failure.
 - **Check Status** - The status of the check as errors or warnings.
 - **Check Information** - The information about the failed checks.
 - **ModelCHECK Mode** - The operating mode of ModelCHECK, whether Interactive, Regenerate, MC_regen, Save, or Batch, in which the models have failed the checks.

Example: A Report on Failed Checks

The following is a report on a failed check in table format that is generated from **Search > Failed Checks** on the metrics tool.

UserId	Date/Time	Model Name	Model Type	Check Name	Check Status	Check Information	ModelCHECK Mode
ykelkar	2004-09-24 16:43:34.0	TIRE	PRT	SHORT_EDGES	ERR	286	MC_regen
ykelkar	2004-09-24 16:42:38.0	BEARING	PRT	SHORT_EDGES	ERR	72	MC_regen
ykelkar	2004-09-24 16:42:49.0	LUG	PRT	SHORT_EDGES	ERR	36	MC_regen
ykelkar	2004-09-24 16:43:12.0	RIM	PRT	SHORT_EDGES	ERR	165	MC_regen
ykelkar	2004-09-24 16:43:19.0	ROTOR	PRT	SHORT_EDGES	ERR	22	MC_regen
ykelkar	2004-09-24 16:43:25.0	SPINDLE	PRT	SHORT_EDGES	ERR	104	MC_regen

Model Accuracy in ModelUPDATE

You can specify the type and value for the model accuracy. In the ModelUPDATE mode, ModelCHECK automatically changes the accuracy to this value if the accuracy is not within the acceptable limits.

Use the following format in the start configuration file:

```
MU_ACCURACY [type] [value]
```

where

- [type] is the type of accuracy (relative or absolute).
- [value] is the value of the accuracy.

For example,

```
MU_ACCURACY RELATIVE 0.001
```

ACCURACY_INFO (Accuracy Information)

Y/N/E/W

Reports the type of accuracy (relative or absolute) and its value. It also reports whether the value set is within an acceptable range. The acceptable limits are set using the following constant configuration options:

- ACCURACY_LOW and ACCURACY_UPP for relative accuracy
- MIN_ABS_ACCURACY and MAX_ABS_ACCURACY for absolute accuracy

ModelCHECK automatically determines the type of accuracy and uses the appropriate values. If the accuracy is not properly set, it can be changed from ModelCHECK. If the ModelUPDATE mode is enabled, this check automatically changes the accuracy value and type according to the MU_ACCURACY option in the start configuration file.

Note: Pro/ENGINEER fully regenerates the model if you change the type or value of the accuracy.

Suggested Settings:

Inter	Batch	Regen	Save
W	W	W	W

ACCURACY_LOW

Defines the minimum acceptable relative accuracy.

ACCURACY_UPP

Defines the maximum acceptable relative accuracy.

ADD_CHK_PARAM (Add a Parameter)

Y/N

Adds or updates a parameter in the model that stores the outcome of another check. The `PRT_ADD_CHK_PARAM`, `ASM_ADD_CHK_PARAM`, and `DRW_ADD_CHK_PARAM` configuration options in the start configuration file are used to specify the parameters to create.

Examples of where parameters can be used include material name, model name, or model units.

Note: When this check is enabled, parameters are automatically updated and created as necessary when running ModelCHECK.

Suggested Settings:

Inter	Batch	Regen	Save
Y	Y	N	Y

ADD_CONFIG_PARM

<Y/N/A>

Creates or updates a parameter called `MC_CONFIG` in all models that are modified and checked. This parameter contains the names of the ModelCHECK configuration files used for a final check of the model.

Note: Set this configuration option for each operating mode. ModelCHECK does not update the `MC_CONFIG` parameter if the model is not modified. However, if the `MC_CONFIG` parameter is not available in the model, ModelCHECK adds it irrespective of whether the model has been modified or not.

ADD_DATE_PARM

<Y/N>

Creates or updates a parameter called `MODEL_CHECK` in the model files of all models that are modified and checked. This parameter contains the date and time when ModelCHECK was last run.

Note: Set this configuration option for each operating mode. ModelCHECK does not update the `MODEL_CHECK` parameter if the model is not modified. However, if the `MODEL_CHECK` parameter is not available in the model, ModelCHECK adds it irrespective of whether the model has been modified or not.

ADD_DUP_INFO_AUTO

<Y/N/A/D>

Configures how duplicate model information is written to the directory specified by the `DIR_MC_DUP_WRITE` configuration option.

- Y - Always adds the model to the database.

- **N** - Never adds the model information to the database.
- **A** - Always asks the user before adding to or overwriting the existing information.
- **D** - Adds the model information but does not overwrite the existing information.

When information is added to the directory, ModelCHECK searches the directory for models with the same name. If a model with the same name is found, you can overwrite the existing data or cancel the addition.

Note: Set this configuration option for each operating mode.

ADD_ERR_PARM

<Y/N>

Creates or updates a parameter called `MC_ERRORS` in all models that are modified and checked. This parameter contains the number of errors found in the model when ModelCHECK was last run.

Note: Set this configuration option for each operating mode. ModelCHECK does not update the `MC_ERRORS` parameter if the model is not modified. However, if the `MC_ERRORS` parameter is not available in the model, ModelCHECK adds it irrespective of whether the model has been modified or not.

ModelCHECK Teacher

This page is part of a series of instructional web pages which accompany ModelCHECK. The ModelCHECK Teacher is designed as an instructional tool to assist users in understanding modeling errors. This reduces the likelihood of them being repeated and thus improves modeling skills. ModelCHECK Teacher can be accessed from the information files for relevant checks.

Additional Information

- **SLA**
Help for Pro/ENGINEER 2D and 3D Data Exchange.
- **External References**
Help for Pro/ENGINEER Fundamentals.
- **Features that are Children of Rounds, Drafts or Chamfers**
Help for Pro/ENGINEER Fundamentals.
- **Drawing Formats**
Help for Pro/DETAIL.
- **Draft Items that are not Attached to a View**
Help for Pro/DETAIL.

- Start Part and Start Assembly Information
 - Datum planes - Help for Pro/ENGINEER Part Modeling.
 - Views - Help for Pro/ENGINEER Fundamentals.
 - Parameters - Help for Pro/ENGINEER Fundamentals.
 - Layers - Help for Pro/ENGINEER Fundamentals.
- Parameter Information
Help for Pro/ENGINEER Fundamentals.
- Geometry Checks
Help for Pro/ENGINEER Part Modeling.
- Unbend and Bend Back Features
Help for Pro/SHEETMETAL.
- Merge and Cutout Features
Help for Pro/ASSEMBLY.

ADD_MODE_PARM

<Y/N/A>

Creates or updates a parameter called `MC_MODE` in all models that are modified and checked. This parameter contains the mode in which ModelCHECK was run on the model.

Note: Set this configuration option for each operating mode. ModelCHECK does not update the `MC_MODE` parameter if the model is not modified. However, if the `MC_MODE` parameter is not available in the model, ModelCHECK adds it irrespective of whether the model has been modified or not.

ADD_MU_STAMP

<Y/N>

Creates a read-only parameter called `MODELUPDATE` in the model to indicate the date and time that the model was last updated in the ModelUPDATE mode.

AE_GTOL_DUPLICATE (Duplicate Geometric Tolerance Annotation Elements)

Y/N/E/W

Reports whether duplicate geometric tolerance annotation elements exist in the part. Geometric tolerance annotation elements are duplicate if they have the same references (dimension, surface, and edge placement) and are of the same type. Moreover, additional options, if you have specified any, must be the same.

Placement references are not considered while determining duplicate geometric tolerance annotation elements.

You can highlight the duplicate annotation element in the Model Tree as well as in the Pro/ENGINEER graphics window. ModelCHECK also allows you to redefine or delete the duplicate annotation element.

You can also access the Global Reference Viewer from the ModelCHECK report to view all references to and from the reported duplicate geometric tolerance annotation elements.

Suggested Settings:

Inter	Batch	Regen	Save
Y	Y	Y	Y

AE_MISSINGREFS (Annotation Elements with Missing References)

Y/N/E/W

Reports all annotation elements that have all user-defined references missing.

You can highlight the annotation element with missing references in the Model Tree as well as in the Pro/ENGINEER graphics window. ModelCHECK also allows you to redefine the annotation feature or delete the annotation element with missing references.

You can also access the Global Reference Viewer from the ModelCHECK report to view all references to and from the annotation element with missing references.

Suggested Settings:

Inter	Batch	Regen	Save
W	W	W	W

AE_SF_DUPLICATE (Duplicate Surface Finish Annotation Elements)

Y/N/E/W

Reports whether duplicate surface finish annotation elements exist in the part. Surface finish annotation elements are duplicate if they have at least one common surface reference.

You can highlight the duplicate annotation element in the Model Tree as well as in the Pro/ENGINEER graphics window. ModelCHECK also allows you to redefine or delete the duplicate annotation element.

You can also access the Global Reference Viewer from the ModelCHECK report to view all references to and from the reported duplicate surface finish annotation elements.

Suggested Settings:

Inter	Batch	Regen	Save
Y	Y	Y	Y

AF_INCOMPLETE (Incomplete Annotation Features)

Y/N/E/W

Reports whether the annotation feature in the part is incomplete. The annotation feature is incomplete when strong references of an annotation element are missing.

ModelCHECK allows you to highlight and fix the annotation features in the Pro/ENGINEER window. In addition, it also allows you to delete annotation elements. You can also invoke the Global Reference Viewer for an incomplete annotation feature from the ModelCHECK report.

Suggested Settings:

Inter	Batch	Regen	Save
W	W	W	W

ANNTN_INACTIVE (Inactive Annotations)

Y/N/E/W

Checks for inactive annotations within a model and allows you to redefine the annotation feature that has the annotations. ModelCHECK also allows you to delete the inactive annotation element.

You can also access the Global Reference Viewer from the ModelCHECK report to view all references to and from the annotation feature which contains the inactive annotation.

Suggested Settings:

Inter	Batch	Regen	Save
W	W	W	W

ASM_BATCH_ALL

<Y/N>

Automatically recurses through all components of an assembly when ModelCHECK is run in Batch mode. Every subassembly and part in the assembly is checked, and a separate report is generated for each of them.

ASM_BOM (Assembly Bill of Materials)

Y/N

Displays the bill of materials of the assembly. You must set this check to *y* for an all-level check on an assembly.

Suggested Settings:

Inter	Batch	Regen	Save
Y	Y	N	N

ASM_FEATURES (Assembly Features)

Y/N

Reports any assembly features, other than datums, in the model.

Suggested Settings:

Inter	Batch	Regen	Save
Y	Y	Y	Y

ASync_PORT

<integer>

Specifies the communications port between ModelCHECK and Pro/ENGINEER to allow feature highlighting and updating. This port number can be from 1000 to 70000. The default is 3001.

ModelCHECK opens this port when Pro/ENGINEER is started. This port remains in use for the duration of the session.

If during startup ModelCHECK detects another process using the default port, it increases the port number by 10 and tries again. ModelCHECK repeats this procedure 5 times before displaying an error message and disabling Java.

BOUND_INFO (Boundary Information)

Y/N/E/W

Checks that no views, entities, dimensions, symbols, notes, and tables lie outside the boundary of a drawing. If any are found, you can highlight the reported views or details in the Pro/ENGINEER window.

Note:

- This check considers the boundary of the drawing and not the boundary of the format. If an item lies outside the boundary of the format but within the boundary of the drawing, ModelCHECK does not report it as a problem.

- If a drawing has no valid views, ModelCHECK does not check for views, entities, dimensions, symbols, notes, and tables lying outside the boundary of the drawing.
- This check does not consider symbols that have groups.

Suggested Settings:

Inter	Batch	Regen	Save
W	W	W	W

BULK_ITEMS (Bulk Items)

Y/N/E/W

Reports any bulk items found in the assembly.

Suggested Settings:

Inter	Batch	Regen	Save
Y	Y	N	Y

BURIED_ADVANCED

<Y/N>

- **Y** - Conducts a computation-intensive analysis of the model to confirm whether the features reported by the BURIED_FEAT check are actually buried features.
- **N** - Uses only the BURIED_FEAT check to check for buried features.

BURIED_FEAT (Buried Features)

Y/N/E/W

Reports any buried features in the model. If any are found, you can highlight them in the Pro/ENGINEER window. Buried features are completely enveloped by another feature.

You can also access the Global Reference Viewer from the ModelCHECK report to view all references to and from the reported features.

If the ModelUPDATE mode is enabled, buried features are automatically deleted.

Suggested Settings:

Inter	Batch	Regen	Save
E	E	E	E

ModelCHECK Teacher: Buried Features

A buried feature is one that is entirely surrounded by or enclosed within other features.

What causes buried features?

The two most common causes of buried features are:

- A cut (or other geometry elimination feature) that completely surrounds a solid feature (protrusion), eliminating it from view.
- A solid feature (protrusion) that completely surrounds another feature (solid or not), eliminating it from view.

Example 1: Cut eliminates the handle on the coffee cup.

In the example below, the designer did not like the handle of the coffee cup, so rather than deleting it, they created a cut (feature #10) that completely eliminated the handle geometry to make room for a new one (all that is shown is the datum curve that was used to create the handle).

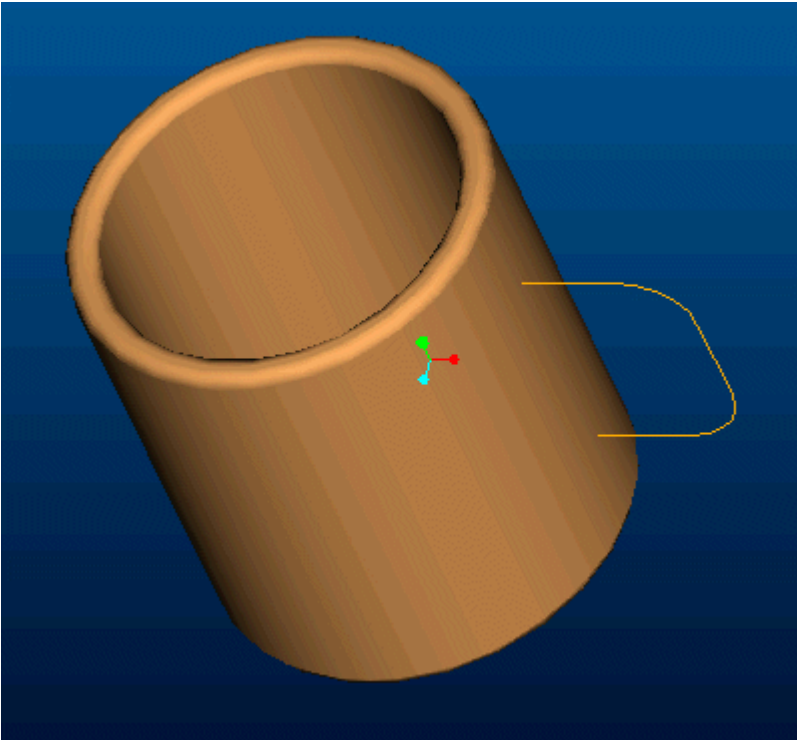
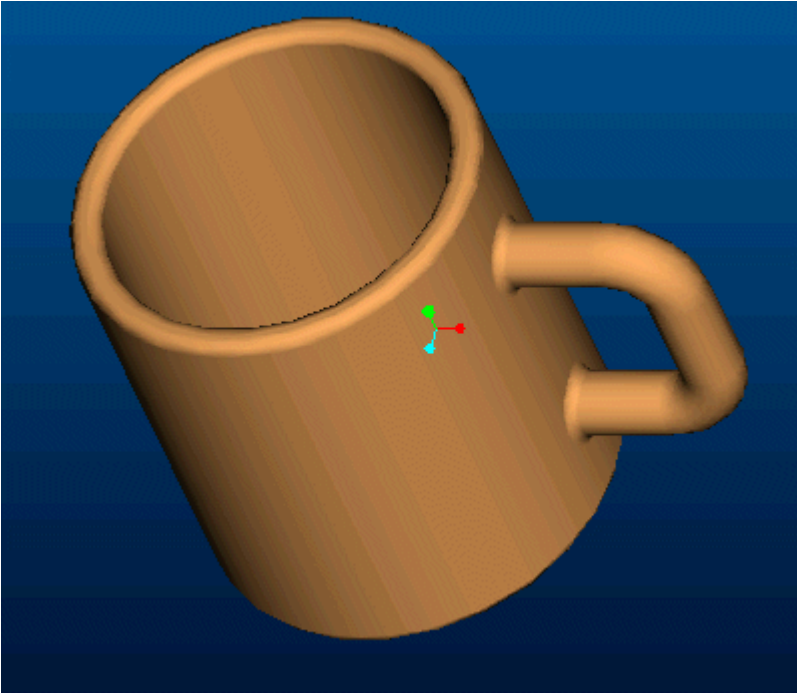

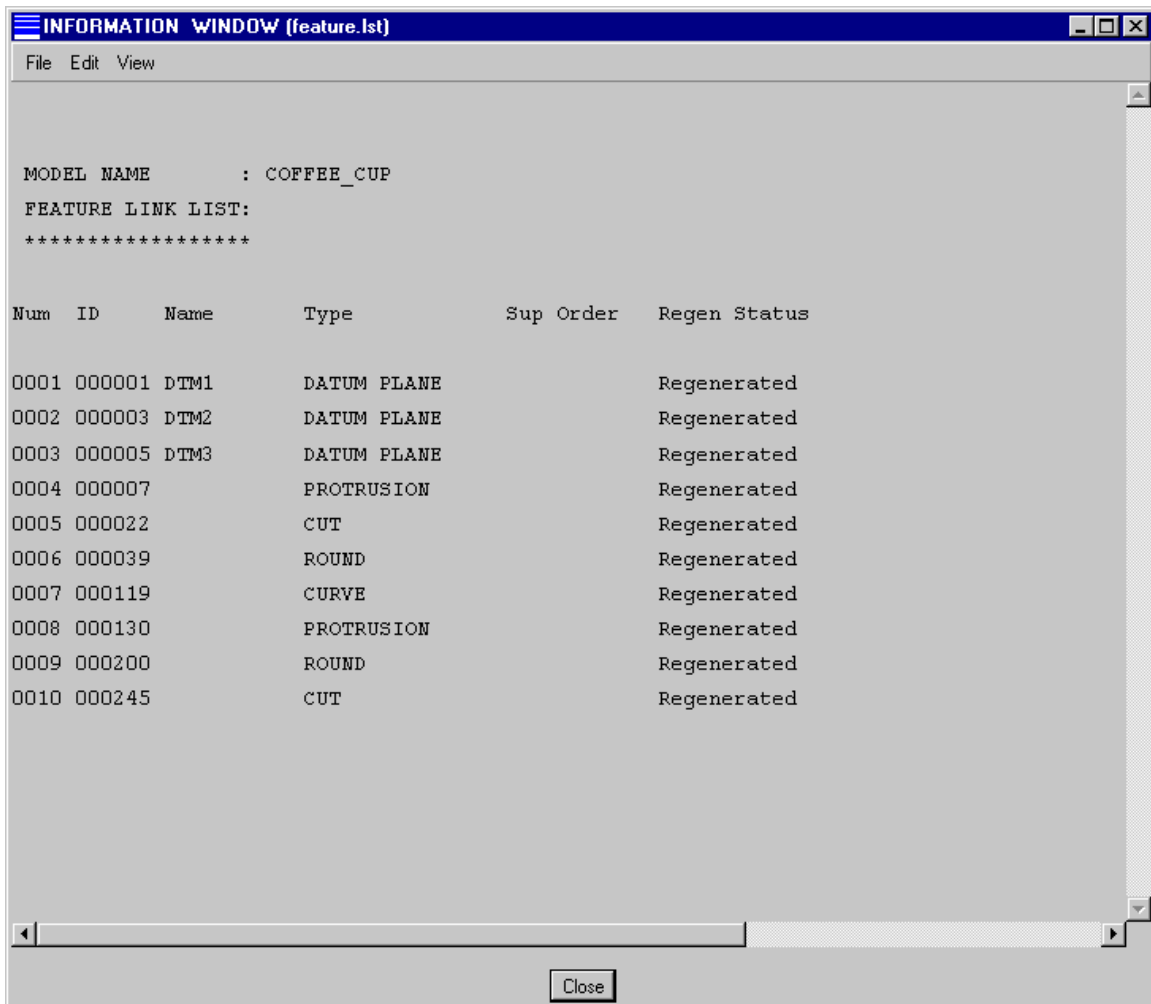

The protrusion used to create the handle is still present but is completely invisible due to the existence of the cut. The correct method would have been to delete or redefine the protrusion rather than creating the cut.

Example 2: Element of patterned protrusion is hidden from view.

In the example below, a protrusion was patterned from right to left. The designer intended to end up with 4 protrusions, but due to a mistake in the dimension value, the last element of the pattern became completely buried. At the next regeneration, ModelCHECK notified the designer of this by highlighting the hidden feature.

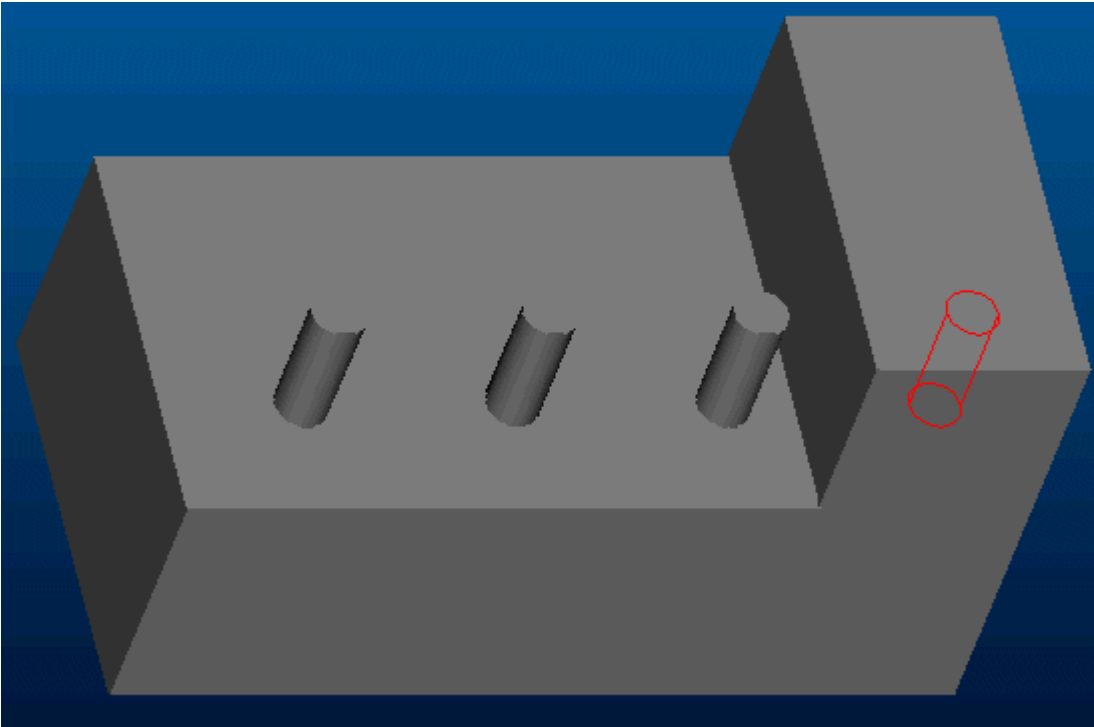
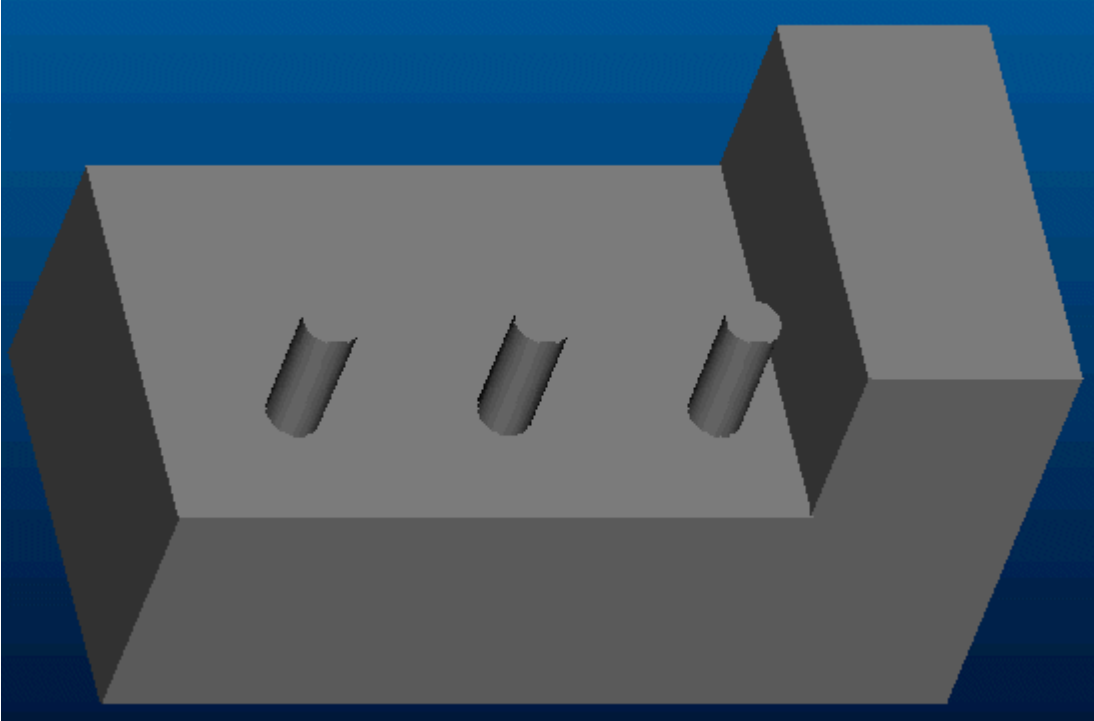

Why are buried features dangerous?

There are a number of reasons why there should not be buried features in a model:

- Intended geometry may be hidden from view.
- Trying to modify or redefine children of buried features can be confusing and difficult. Unexpected feature failures may occur.
- Pro/ENGINEER files will be larger than necessary.
- The model will take longer to regenerate than it should because of the extra features.

How can buried features be avoided?

There is no way to query Pro/ENGINEER to identify buried features. The only way is to use the Model Tree to highlight features one by one. You then have to examine each feature to identify if it is buried. The alternative is to have ModelCHECK tell you if there are any.

C7_SELF_DIST (Distance from Itself)

Y/N/E/W

GeomIntegrityCHECK checks the proximity of the boundary-curve bounded surfaces to appurtenant surfaces. It reports the boundary curve if the curve extends beyond the parameter range of the surface.

Suggested Settings:

Inter	Batch	Regen	Save
E	E	N	N

CHAMFER_CHILD (Children of Chamfers)

Y/N/E/W

Reports any features that are children of chamfers. If any are found, you can highlight them in the Pro/ENGINEER window.

You can also access the Global Reference Viewer from the ModelCHECK report to view all references to and from the reported features.

Suggested Settings:

Inter	Batch	Regen	Save
E	E	E	E

CHECK_ALL_MODELS

<Y/N>

Specifies whether ModelCHECK must check all the models of an assembly irrespective of whether the models have been changed after they were retrieved or the value of the MC_ERRORS parameter.

- Y - Always checks all models ignoring the setting of the SKIP_MODELS configuration option.
- N - Checks models according to the setting of the SKIP_MODELS configuration option.

ModelCHECK Teacher: Features that are Children of Rounds, Drafts, or Chamfers

Underlying each feature are relationships that link it to one or more features that came before it in the model. These links are referred to as Parent-Child Relationships and are created any time one feature references another. The feature that is referenced is referred to as the parent. The feature that references the parent is referred to as the child.

All features except the base feature and default coordinate system are children of other features.

What causes features that are children of rounds, drafts or chamfers?

A feature becomes a child of a round, draft, or chamfer when one of these features is used as a sketching (sketch or orientation) or dimensioning reference.

Why are features that are children of rounds, drafts or chamfers dangerous?

Parent-Child Relationships make Pro/ENGINEER parametric, one of its most powerful attributes. When used correctly, they contribute to intelligent, well designed models. When used incorrectly however, unexpected problems can arise. Such can be the case when rounds, drafts, and chamfers are referenced by other features.

The problem with referencing edges and surfaces of rounds, drafts, and chamfers is that dimensions of these features are commonly changed or the feature is removed entirely.

In the images below, the protrusion was located by dimensioning its center to the edge of the round. This made the round a parent of the protrusion. Therefore, if the radius of the round is changed, the position of the protrusion will also change. It would have been better to have dimensioned the protrusion to the side surface of the base.

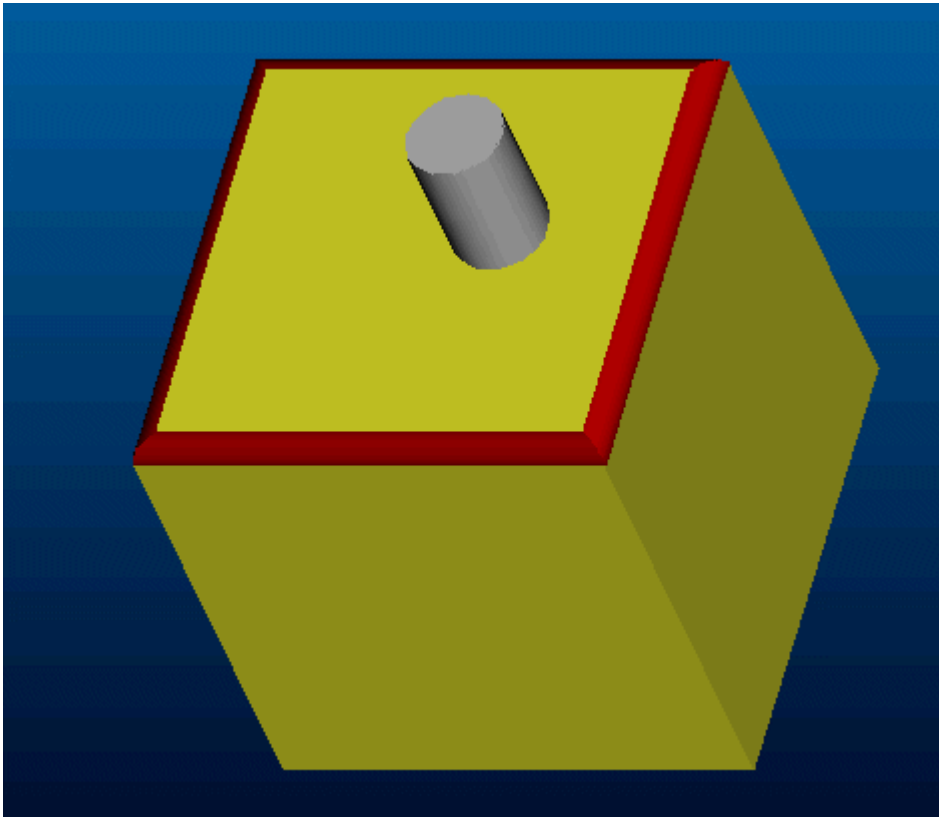
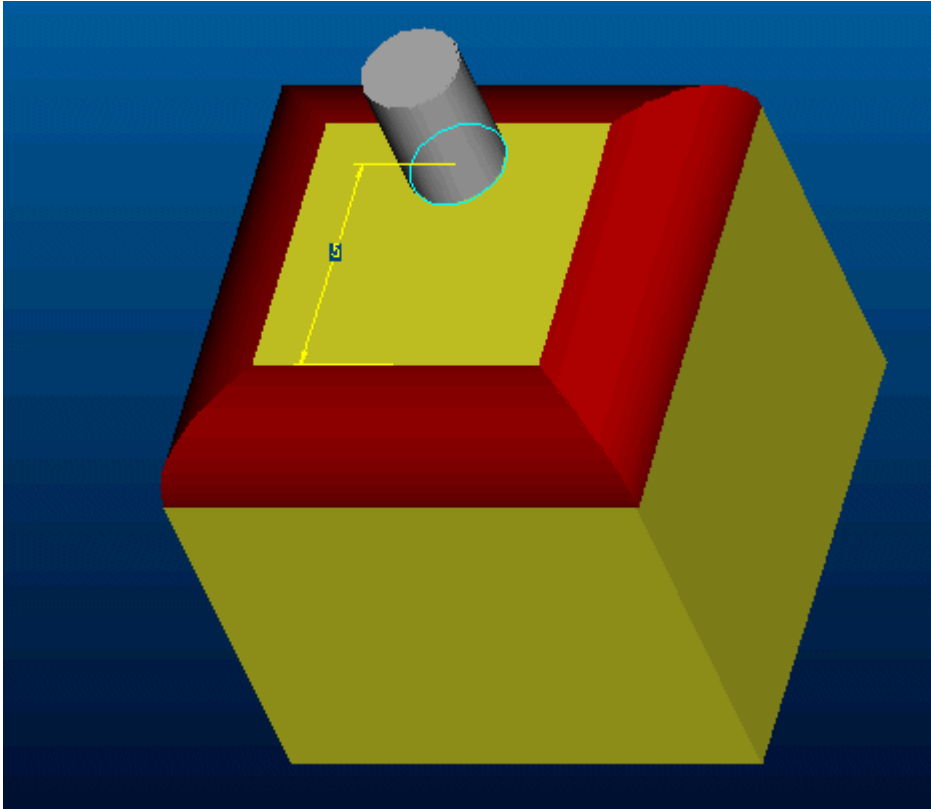

How can features that are children of rounds, drafts or chamfers be avoided?

- Always use default datum planes for all your parts and assemblies.
- Dimension to default datums or base features.
- Dimension to surfaces and not edges.
- Use Query Select when dimensioning to ensure the proper references are selected.
- Create rounds, drafts, and chamfers as late as possible in the model.
- If rounds, drafts, and chamfers have to be added early, suppress them to make it easier to select references for new features without creating undesirable Parent-Child Relationships.

CHILDREN_EXIST (Standard Children)

Y/N/E/W

Checks for the existence of a set of standard named features. If they are found, ModelCHECK checks for the existence of standard named children.

If the parent features do not exist in the model, ModelCHECK does not check for the children.

Parent features and their children are listed using the `PRT_CHILD_EXIST` and `ASM_CHILD_EXIST` configuration options.

Suggested Settings:

Inter	Batch	Regen	Save
E	E	E	E

CIRCULAR_REFS (Circular References)

Y/N/E/W

Checks for any circular references in the assembly. Circular references occur when an assembly contains a number of cross references that form a loop.

ModelCHECK reports all the circular references. You can highlight the features or components involved.

Suggested Settings:

Inter	Batch	Regen	Save
Y	Y	Y	N

CNFG_SELECT_AUTO

<Y/N/A>

Configures whether ModelCHECK loads the configuration files automatically based on the rules in the `condition.mcc` file, or whether you can load the configuration files using the **Load Config** menu commands in Pro/ENGINEER (**Analysis > ModelCHECK > Load Config**).

- **Y** - ModelCHECK automatically chooses the configuration files.
- **N** - ModelCHECK requires you to choose the configuration files.
- **A** - ModelCHECK performs neither option **Y** nor option **N** automatically. Instead, ModelCHECK prompts you to choose between having ModelCHECK choose the configuration files or prompt you to choose the configuration files on starting Pro/ENGINEER.

The **N** option requires a file called `setconf.mcc` in the ModelCHECK `config` directory. This file is used to name and specify the Pro/ENGINEER menu commands for selecting configuration files.

COSMETIC_FEAT (Cosmetic Features)

Y/N

Lists the cosmetic features in the model.

You can also access the Global Reference Viewer from the ModelCHECK report to view all references to and from the reported features.

Suggested Settings:

Inter	Batch	Regen	Save
Y	Y	N	N

CREATE_VIEW (Create Views)

Y/N

Creates views as specified by the `PRT_CREATE_VIEW` option in the start configuration file.

Create Views for ModelUPDATE

You can specify details of views to be created by ModelUPDATE if configured to do so in the `CREATE_VIEW` check. Use the following format in the start configuration file:

```
PRT_CREATE_VIEW [view name] [axis] [direction] [reference axis]
[orientation]
```

where

- `[view name]` is the name of the view. The name is not case-sensitive.

- [axis] is the primary axis for the view. The values are X, Y, or Z.
- [direction] is the direction of the primary axis. The values are 0 (away from you) or 1 (toward you).
- [reference axis] is the secondary axis for the view. The values are the two axes other than the primary axis.
- [orientation] is the angle (counter-clockwise) in degrees of the reference axis about the primary axis. The values are 0, 90, 180, and 270.

For example:

```
PRT_CREATE_VIEW MC_VIEW1 X 1 Y 270
PRT_CREATE_VIEW MC_VIEW2 Y 0 Z 90
```

Custom Checks File

Specifies the name of the external text file in which custom checks are listed in the start configuration file. For example:

```
CUSTOM_CHECKS_FILE c:\apps\mc\config\text\custom_checks.txt
CUSTMTK_CHECKS_FILE text\custmtk_checks.txt
```

where `custom_checks.txt` is used to specify new checks created from two or more checks and `custmtk_checks.txt` is used to specify the custom checks created using Pro/TOOLKIT.

CYL_CUT_SLOTS (Cuts and Slots That Should Be Holes)

Y/N/E/W

Reports any circular cuts or slots in the model that could have been modeled using holes instead. If any are found, you can highlight the features in question in the Pro/ENGINEER window. This check ignores cylindrical features that have been created using the **Revolve** command.

You can also access the Global Reference Viewer from the ModelCHECK report to view all references to and from the reported features.

Suggested Settings:

Inter	Batch	Regen	Save
W	W	W	W

CYL_DIAMS (Circular Cut Diameters)

Y/N/E/W

Reports any circular cuts in the model without standard diameters. If any are found, you can highlight the features in question in the Pro/ENGINEER window.

You can also access the Global Reference Viewer from the ModelCHECK report to view all references to and from the reported features.

Standard cut diameters are listed in a text file specified by the `STD_HOLE_DIAM_FILE` start configuration option (The same file is used for hole diameters.)

Suggested Settings:

Inter	Batch	Regen	Save
E	E	E	E

D28_IGES_TEXT (IGES Conform Text)

Y/N/E/W

In drawings, GeomIntegrityCHECK reports text that does not conform to IGES fonts.

Suggested Settings:

Inter	Batch	Regen	Save
E	E	N	N

DATUM_RENAME (Renaming Datums)

Y/N/E/W

If this check is enabled and a specified datum is found in the model, ModelCHECK renames it as specified. Datum names to be renamed are specified using the `PRT_DATUM_RENAME` and `ASM_DATUM_RENAME` start configuration options.

Suggested Settings:

Inter	Batch	Regen	Save
W	W	N	W

ModelCHECK Teacher: Datum Features

Datums are non solid geometric objects that are used as construction features to help model other features and assemble components. The major different types of datums are:

- Planes
- Coordinate Systems
- Axes
- Curves
- Points

There are several key rules to follow when using datums:

- Always start new parts and assemblies with default datum planes and coordinate systems.
- If you do not need a datum, delete it, it is overhead to your model.
- If ModelCHECK complains that there is a datum plane that has only one parent that is also a datum plane, do the following:
 - Redefine the children so that they reference the parent datum plane.
 - Delete the datum plane.

DEF_DENSITY (Model Density)

Y/N/E/W

Checks that the model's density is not the default (1.00). If it is the default, update the density from the ModelCHECK report.

Suggested Settings:

Inter	Batch	Regen	Save
W	W	N	E

DEFAULT_CHILD (Children of the Default Datum Planes)

Y/N

Reports the number of features that are direct children of the default datum planes.

Suggested Settings:

Inter	Batch	Regen	Save
Y	Y	N	N

DEFAULT_VIEWS (Views with the Default Hidden Line Display Mode)

Y/N/E/W

Reports any views with the hidden line display mode set to the default (and not the other options, namely, **Wireframe**, **Hidden Line**, and **No Hidden**) in a drawing.

If any views are found, you can be highlight them from the report.

Suggested Settings:

Inter	Batch	Regen	Save
W	W	N	W

DEPENDENT_FEATURE (Dependent Features)

Y/N/E/W

Checks for the existence of dependent features. A dependent feature is created when you copy a feature by translating, rotating, or mirroring it. The copied as well as the original features are reported and can be highlighted.

Suggested Settings:

Inter	Batch	Regen	Save
N	N	N	N

DESIGNATE_MU_STAMP

<Y/N>

Designates the MODELUPDATE parameter which indicates the date and time that the model was last updated in the ModelUPDATE mode for use with a data management system.

DESIGNATED_ATTR (Designated Attributes)

Y/N/E/W

Reports the designated parameters in a model. Designated parameters are identified for use as attributes in a PDM system.

Suggested Settings:

Inter	Batch	Regen	Save
N	N	N	N

DIM_OVERWRITE (Overwritten Dimensions)

Y/N/E/W

Reports any dimensions modified using @0, which breaks their associations with the model, allowing you to enter whatever value you choose.

If any overwritten dimensions are found, you can highlight the features in question in the Pro/ENGINEER window.

Suggested Settings:

Inter	Batch	Regen	Save
E	E	E	E

ModelCHECK Teacher: Dimensions

ModelCHECK reports two types of dimensions:

- Shown dimensions

Dimensions that are created using the same dimensional constraints as the model

- Created dimensions

Dimensions that are created in Drawing Mode.

It is highly recommended that you use as many shown dimensions as possible for the following reasons:

- It is faster to detail your drawing this way.
- It is more difficult to make mistakes because the same dimensions that were used to constrain the part are used for the drawing.
- Dimensions can be modified from the drawing and the changes will be updated in the model.

Created dimensions should only be used in cases where the model does not contain adequate dimensioning scheme for manufacturing.

DIR_MC_BACKUP_CONFIG

<directory path>

Specifies the path to a directory in which earlier versions of the ModelCHECK configuration files are stored. The format for the file names is <filenamedatettime>. For example, `default_checks.mch200502111943`, where the date is in the `yyyymmdd` format and the time is in the `hhmm` format.

DIR_MC_BACKUP_CONFIG_NT

<directory path>

Specifies the path on Windows NT to a directory in which earlier versions of the ModelCHECK configuration files are stored. If this option is not set, the `DIR_MC_BACKUP_CONFIG` configuration option is used.

DIR_MC_BACKUP_CONFIG_U

<directory path>

Specifies the path on UNIX to a directory in which earlier versions of the ModelCHECK configuration files are stored. If this option is not set, the `DIR_MC_BACKUP_CONFIG` configuration option is used.

DIR_MC_DUP_READ

<directory path>

Specifies the path to a directory from which duplicate model information is read. ModelCHECK reads a file called `mc_dup_model.bin` from this location. The directory specified by the `DIR_MC_DUP_READ` configuration option should be a common directory for all users.

Reuse this option up to 50 times to specify more than one location to read from. Use a new line for every location.

Note: This option is used only if the `DIR_MC_DUP_READ_NT` or `DIR_MC_DUP_READ_U` configuration options are not set. If none of the options are set, the directory from which Pro/ENGINEER was started is used by default.

DIR_MC_DUP_READ_NT

<directory path>

Specifies the path on Windows NT to a directory from which duplicate model information is read. If this option is not set, the `DIR_MC_DUP_READ` configuration option is used.

DIR_MC_DUP_READ_U

<directory path>

Specifies the path on UNIX to a directory from which duplicate model information is read. If this option is not set, the `DIR_MC_DUP_READ` configuration option is used.

DIR_MC_DUP_WRITE

<directory path>

Specifies the path to a directory in which duplicate model information is written. The directory specified by the `DIR_MC_DUP_WRITE` configuration option should be a central directory for all users.

ModelCHECK writes a file called `mc_dup_model.bin` to this location when you exit Pro/ENGINEER.

Note: This option is used only if the `DIR_MC_DUP_WRITE_NT` or `DIR_MC_DUP_WRITE_U` configuration options are not set. If none of the options are set, the directory from which Pro/ENGINEER was started is used by default.

DIR_MC_DUP_WRITE_NT

<directory path>

Specifies the path on Windows NT to a directory in which duplicate model information is written. If this option is not set, the `DIR_MC_DUP_WRITE` configuration option is used.

DIR_MC_DUP_WRITE_U

<directory path>

Specifies the path on UNIX to a directory in which duplicate model information is written. If this option is not set, the `DIR_MC_DUP_WRITE` configuration option is used.

DIR_MC_PREVIEW

<directory path>

Specifies the path to a directory in which the temporary files created by the preview process are stored. The default path is `c:\Temp` (Windows NT) or `/tmp` (UNIX).

Note: This option is used only if the `DIR_MC_PREVIEW_NT` or `DIR_MC_PREVIEW_U` configuration options are not set. If none of the options are set, the directory from which Pro/ENGINEER was started is used by default.

DIR_MC_PREVIEW_NT

<directory path>

Specifies the path on Windows NT to a directory in which the temporary files created by the preview process are stored. If this option is not set, the `DIR_MC_PREVIEW` configuration option is used.

DIR_MC_PREVIEW_U

<directory path>

Specifies the path on UNIX to a directory in which the temporary files created by the preview process are stored. If this option is not set, the `DIR_MC_PREVIEW` configuration option is used.

DIR_METRICS

<directory path>

Specifies the path to a directory in which metrics flat files are written. The directory specified by the `DIR_METRICS` configuration option should be a common directory for all users, for easy compilation and management of the flat files.

For performance reasons, the flat file is initially written to the directory specified by the `DIR_REPORT` configuration option and is moved to the directory specified by the `DIR_METRICS` configuration option when you exit Pro/ENGINEER.

Note: This option is used only if the `DIR_METRICS_NT` or `DIR_METRICS_U` configuration options are not set. If none of the options are set, the directory from which Pro/ENGINEER was started is used by default.

DIR_METRICS_NT

<directory path>

Specifies the path on Windows NT to a directory in which metrics flat files are written. If this option is not set, the `DIR_METRICS` configuration option is used.

DIR_METRICS_U

<directory path>

Specifies the path on UNIX to a directory in which metrics flat files are written. If this option is not set, the `DIR_METRICS` configuration option is used.

DIR_REPORT

<directory path>

Specifies the path to a directory in which ModelCHECK, including ModelUPDATE, reports are to be written. If the specified directory does not exist or is specified incorrectly, reports are placed in the directory from which Pro/ENGINEER was started.

If ModelCHECK is running on a server and is used by many clients, it is suggested that each user have his or her own report directory. To do this, create a directory called `mc_reports` as a subdirectory of your home directory. Then set the `DIR_REPORT` configuration option to `$HOME/mc_reports`.

To optimize ModelCHECK for speed, place the directory specified by the `DIR_REPORT` configuration option on your machine.

The reports generated in the ModelUPDATE mode have `mu` as a part of the filename.

Note: This option is used only if the `DIR_REPORT_NT` or `DIR_REPORT_U` configuration options are not set.

DIR_REPORT_NT

<directory path>

Specifies the path on Windows NT to a directory in which ModelCHECK, including ModelUPDATE, reports are to be written. If this option is not set, the `DIR_REPORT` configuration option is used.

DIR_REPORT_U

<directory path>

Specifies the path on UNIX to a directory in which ModelCHECK, including ModelUPDATE, reports are to be written. On a UNIX system, you can specify the `/tmp` directory to write the report files to, so that the directory is cleaned each time the machine is rebooted.

If this option is not set, the `DIR_REPORT` configuration option is used.

Draft Angle File

Specifies the name of the external text file in which standard draft angles are listed in the start configuration file. For example:

```
STD_DRAFT_ANGLE_FILE c:\apps\mc\config\text\draft.txt
```

The draft angle file has the following format:

```
# ModelCHECK Standard Draft Angles File
#
UNIT DEGREE
.25
.5
.75
```

Note: The declaration of units must be in uppercase.

DRAFT_ANGLES (Standard Draft Angles)

Y/N/E/W

Reports whether any draft features in the model do not have standard draft angles. If any are found, you can highlight the features in question in the Pro/ENGINEER window.

You can also access the Global Reference Viewer from the ModelCHECK report to view all references to and from the reported features.

Standard draft angles are listed in a text file specified by the `STD_DRAFT_ANGLES_FILE` start configuration option.

Suggested Settings:

Inter	Batch	Regen	Save
E	E	E	E

DRAFT_CHILD (Children of Draft)

Y/N/E/W

Lists the features that are children of draft features. If any are found, you can highlight them in the Pro/ENGINEER window.

You can also access the Global Reference Viewer from the ModelCHECK report to view all references to and from the reported features.

Suggested Settings:

Inter	Batch	Regen	Save
E	E	E	E

DRAFT_GEOM (Draft Geometry not Associated to a View)

Y/N/E/W

Reports any draft geometry in the model that is not associated with a view.

Suggested Settings:

Inter	Batch	Regen	Save
W	W	W	W

ModelCHECK Teacher: Draft Entities that are not Attached to a View

Draft entities in drawing mode can be attached to a view. This means that when the view is moved or resized, the draft entities will move along with the view.

ModelCHECK notified you of any draft items in your drawing that are not attached to a view and allows you to highlight them from your Web browser.

To relate or attach draft entities to a view, use the following menu picks from drawing mode: **Views, Relate View**, pick the view to relate the entities to, then pick the draft entities to attach.

Drawing Detail File

The settings in the current drawing detail file, also known as the drawing setup file, are compared to the settings in a standard drawing detail file that is saved on disk.

Different standard drawing detail files can be specified for different format names using the `STD_DRW_DTL_FILE` start configuration option as follows:

```
STD_DRW_DTL_FILE [format_name] [path to the drawing detail file]
```

A line-by-line comparison between the specified drawing detail file and the one that is currently set for the drawing is performed and any discrepancies are reported in the ModelCHECK report.

There is no limit to the number of standard drawing detail files that you can specify. It is suggested that you set the following line at the end of all standard drawing detail file listings in the start configuration file:

```
STD_DRW_DTL_FILE DEFAULT [file_name]
```

The standard drawing detail file specified in the DEFAULT line is used if the format for the drawing being checked is not listed in the lines before it in the start configuration file.

Drawing Format

Standard drawing formats are listed in the start configuration file as shown in the following example:

```
DRW_FORMAT A_MFG
DRW_FORMAT A_QC
```

Any formats listed here must be files having the `.frm` extension and located in a directory where Pro/ENGINEER can find them. This means that they either have to exist in the Pro/ENGINEER formats directory or in a location specified by the `PRO_FORMAT_DIR` configuration option in your `config.pro` file.

Drawing Information

You can specify the location of an external text file for drawing formats using the `STD_DRW_INFO_FILE` start configuration option.

The external text file may contain the following drawing items:

Drawing model name specifications	DRW_MODEL_NAME
Drawing format for the FORMAT_NAME check	DRW_FORMAT
Drawing parameters for the STARTCHECK check	DRW_PARAMETER
Drawing layers for the STARTCHECK check	DRW_LAYER
Drawing layer move specifications for the LAYER_MOVE check	DRW_LAYER_MOVE
Drawing note font name specifications for the NOTE_FONT check	DRW_NOTE_FONT
Drawing note height specifications for the NOTE_HEIGHT check	DRW_NOTE_HEIGHT
Drawing table cell specifications for the TABLE_CELLS check	DRW_TABLE_CELLS
Unacceptable notes for the NOTE_UNACCEPT check	DRW_NOTE_UNACC
Add a check name and value as a parameter	DRW_ADD_CHK_PARAM
Version string for the PRO_VERSION check	DRW_PRO_VERSION
Sheets to ignore during ModelCHECK	DRW_IGNORE_SHEETS

DRAWING_LAYERS (Drawing Layers)

Y/N/E/W

Adds all layer functionality from Part and Assembly modes to Drawing mode.

If the ModelUPDATE mode is enabled, ModelCHECK automatically performs the STARTCHECK, LAYER_PLACE, LAYER_STATUS, LATER_MOVE, EXTRA_LAYERS, and LAYER_UNWANTED checks.

Suggested Settings:

Inter	Batch	Regen	Save
E	E	W	W

DRAWING_NAME (Drawing Name)

Y/N/E/W

Verifies that the name of the drawing conforms to the standard naming conventions defined by the DRW_MODEL_NAME start configuration option.

Suggested Settings:

Inter	Batch	Regen	Save
E	E	W	W

Drawing Note Fonts and Heights

Standard note fonts and heights are listed in the start configuration file as shown in the following example:

```
DRW_NOTE_FONT leroy
DRW_NOTE_FONT isofont
DRW_NOTE_HEIGHT .25
DRW_NOTE_HEIGHT .35
```

DRAWING_PARAMS (Parameter Checks)

Y/N/E/W

Enables the following parameter checks in Drawing mode:

Missing parameters	STARTCHECK
Parameter errors	PARAMCHECK
Spelling errors	PARAM_SPELL

Rename specifications	PARAM_RENAME
Parameters not included in start list	EXTRA_PARAMS

Suggested Settings:

Inter	Batch	Regen	Save
E	E	W	W

Drawing Sheets to be Ignored

Drawing sheets to be ignored are specified in the start configuration file using the following syntax:

```
DRW_IGNORE_SHEETS [PARAM_NAME] [Sheet]
```

Where

- [PARAM_NAME] is the name of a parameter that must exist in the drawing in order to complete this check. If the parameter does not exist, this check is skipped.
- [Sheet] is the sheet number to be skipped. Acceptable values are:
 - FIRST - The first sheet in the drawing
 - LAST - The last sheet in the drawing
 - ## - A specific sheet number
 - LIST_xxx - A list of sheets. You can create a list using the following syntax:

```
LIST_xxx 1
```

```
LIST_xxx 2
```

Drawing Symbols

Standard drawing symbols are listed in the start configuration file as shown in the following example:

```
DRW_SYMBOL PTC_LOGO
```

```
DRW_SYMBOL ANSI
```

Drawing Table Cells

This check verifies that specific table cells contain standard text. Standard table cell text is designated using the DRW_TABLE_CELLS configuration option in the start configuration file.

Tables are identified by looking for a certain cell with specific text in it. Once found, ModelCHECK looks for a second cell and makes sure that it contains standard text.

Format

This is set up using the following syntax:

```
DRW_TABLE_CELLS [row1, col1, str1] [row2, col2, str2]
```

For example:

```
DRW_TABLE_CELLS [1,1,BOM] [4,2,PTC]
```

Then, a certain cell can be checked in every table for specific text.

This is set up as follows:

```
DRW_TABLE_CELLS [row,col,string]
```

DRW_SHEET_ALL

<Y/N/A>

Runs ModelCHECK on drawings with multiple sheets.

- **Y** - Runs ModelCHECK automatically on all sheets.
- **A** - Prompts you whether to run ModelCHECK on the current sheet or on all sheets.
- **N** - Runs ModelCHECK only on the current sheet.

Note: Set this configuration option for each operating mode.

ModelCHECK Teacher: Drawing Formats

A drawing format is a standard or customized template for a drawing. It can contain a border, title block, standard tables, parameters, and notes that can be used on multiple drawings.

Formats can be added to a drawing at the time of drawing creation, when Pro/ENGINEER prompts you for the format to use. They can also be added or changed by selecting: **Sheets, Format, Add/Replace** from within drawing mode. If the format contains any references to model parameters, the model has to be added to the drawing prior to the format in order for the drawing to reference the parameters.

For example, the following standard formats can be used in your drawings:

- A_MFG
- A_QC
- A_PURCH

DTM_AXES_INFO (Datum Axis Information)

Y/N

Lists all datum axes found in the model.

Suggested Settings:

Inter	Batch	Regen	Save
Y	Y	N	N

DTM_CSYS_INFO (Coordinate System Information)

Y/N

Lists all datum coordinate systems found in the model.

Suggested Settings:

Inter	Batch	Regen	Save
Y	Y	N	N

DTM_CURVE_INFO (Datum Curve Information)

Y/N

Lists all datum curves found in the model.

Suggested Settings:

Inter	Batch	Regen	Save
Y	Y	N	N

DTM_PLANE_INFO (Datum Plane Information)

Y/N

Lists all datum planes found in the model.

Suggested Settings:

Inter	Batch	Regen	Save
Y	Y	N	N

DTM_POINT_INFO (Datum Point Information)

Y/N

Lists all datum points found in the model.

Suggested Settings:

Inter	Batch	Regen	Save
Y	Y	N	N

DUPLICATE_MODELS (Duplicate Models)

Y/N/E/W

Lists the models in your shape indexing database that are similar in shape to the model being checked.

Suggested Settings:

Inter	Batch	Regen	Save
W	W	W	W

ModelCHECK Teacher: Early Drafts and Rounds

ModelCHECK counts the number of features in the model and makes sure that there are no rounds or drafts created within the first specified percentage of all the features. This percentage is specified in the configuration file defined by the system administrator.

Why are early drafts and rounds dangerous?

A draft feature is used in molded and cast parts. When draft is used, it is typically applied to all surfaces of the model. Therefore, applying draft near the end of model creation is good design practice; it avoids undesirable parent-child relationships and allows you to apply draft in only one step.

Rounds are most often applied to a part after the design is complete to give it a finished look and to eliminate sharp edges. If they are added to models too early in the design stage they may effect the model when additional features are added, and undesirable Parent-Child Relationships may be created.

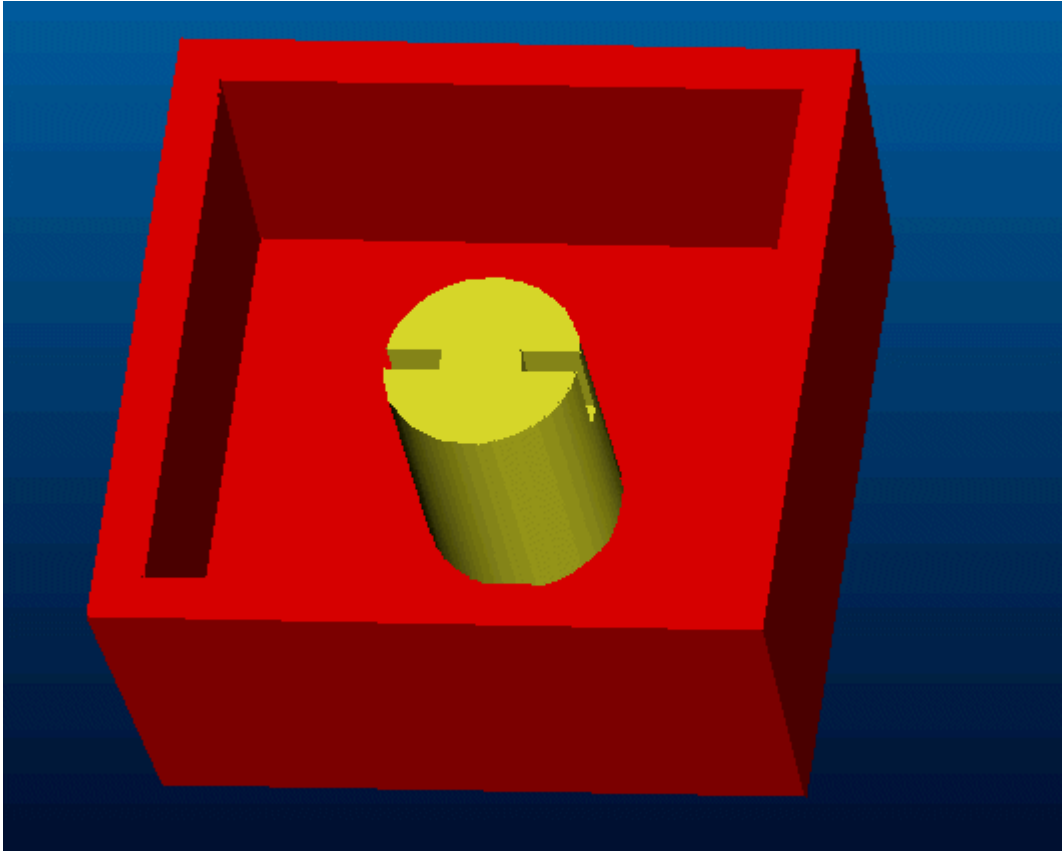

```

MODEL NAME      : EARLY_DRAFT
FEATURE LINK LIST:
*****

Num  ID      Name      Type

0001 000001 DTM1      DATUM PLANE
0002 000003 DTM2      DATUM PLANE
0003 000005 DTM3      DATUM PLANE
0004 000007          PROTRUSION
0005 000028          SHELL
0006 000046          DRAFT
0007 000087          PROTRUSION
0008 000106          CUT

```

In the above example, draft was added to the button too early in the design and as a result, the shell, protrusion and cut do not have draft applied to them. This part will be impossible to mold.

EARLY_CHAMFER (Early Chamfers)

Y/N/E/W

Lists the chamfers in the early features of the model. Early features appear within a specified percentage of all the features in the model starting from the top of the Model Tree. The percentage is defined by the `PERC_EARLY_CHAMF` start configuration option.

If any are found, you can highlight the features in question in the Pro/ENGINEER window.

You can also access the Global Reference Viewer from the ModelCHECK report to view all references to and from the reported features.

Suggested Settings:

Inter	Batch	Regen	Save
E	E	E	E

EARLY_COSMETIC (Early Cosmetic Features)

Y/N/E/W

Lists cosmetic features in the early features of the model. Early features appear within a specified percentage of all the features in the model starting from the top of the Model Tree. The percentage is defined by the `PERC_EARLY_COSMETIC` start configuration option.

If any are found, you can highlight them in the Pro/ENGINEER window.

You can also access the Global Reference Viewer from the ModelCHECK report to view all references to and from the reported features.

Suggested Settings:

Inter	Batch	Regen	Save
W	W	W	W

EARLY_DRAFT (Early Draft)

Y/N/E/W

Lists the drafts in the early features of the model. Early features appear within a specified percentage of all the features in the model starting from the top of the Model Tree. The percentage is defined by the `PERC_EARLY_DRAFT` start configuration option.

If any are found, you can highlight the features in question in the Pro/ENGINEER window.

You can also access the Global Reference Viewer from the ModelCHECK report to view all references to and from the reported features.

Suggested Settings:

Inter	Batch	Regen	Save
E	E	E	E

EARLY_ROUND (Early Rounds)

Y/N/E/W

Lists rounds in the early features of the model. Early features appear within a specified percentage of all the features in the model starting from the top of the Model Tree. The percentage is defined by the `PERC_EARLY_ROUND` start configuration option.

If any are found, you can highlight the features in question in the Pro/ENGINEER window.

You can also access the Global Reference Viewer from the ModelCHECK report to view all references to and from the reported features.

Suggested Settings:

Inter	Batch	Regen	Save
E	E	E	E

EDGE_REFERENCES (Features That Reference Edges)

Y/N/E/W

Lists features that have been created using edges as dimension reference points. If any are found, you can highlight them in the Pro/ENGINEER window.

You can also access the Global Reference Viewer from the ModelCHECK report to view all references to and from the reported features.

Suggested Settings:

Inter	Batch	Regen	Save
E	E	E	E

ERASED_VIEWS (Erased Views)

Y/N/E/W

Checks for erased views in the drawing. Erased views exist in the drawing until they are deleted.

If any erased views are found, you can highlight, delete, or resume them from the ModelCHECK report. If the ModelUPDATE mode is enabled, the erased views are automatically deleted from the drawing.

Suggested Settings:

Inter	Batch	Regen	Save
E	E	E	E

ModelCHECK Teacher: External References

An external reference is created when a feature of one component in an assembly references a feature in a different component. The references can take the form of dimensioning, aligning or sketching.

What causes external references?

They can be created for any of the following reasons:

- When working on a part in assembly mode.
- A part is created in assembly mode and sketcher or dimensioning references are made to features that belong to other parts.
- A feature of a part is redefined in assembly mode and sketcher or dimensioning references are made to features that belong to other parts or assembly features.

Example: In the assembly below, the orange disk was created in assembly mode using an offset edge reference from the outside surface of the gray cup. This gave the disk an external reference to the cup.

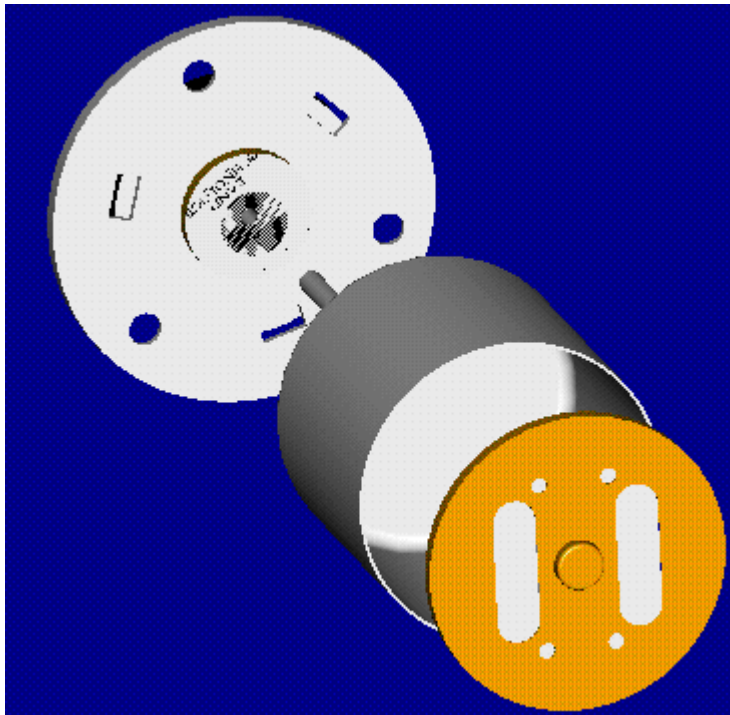

Why are external references dangerous?

If a model has an external reference, it becomes dependent on another model. This means that if you modify a dimension in a model to which another one is dependent, the next time you retrieve the dependent model, it may have changed unexpectedly.

In some cases you can use external references to your advantage, but do so carefully. An example of an effective use of external references is if you want to design a shaft that should always fit into a specific hole. Create the shaft in assembly mode with the part containing the hole already assembled. From SKETCHER, choose **Use Edge** and pick the edges of the hole as references. Now the diameter of the shaft will always be equal to the diameter of the hole. When doing this, make sure the part is not reused in another assembly, its dimensions will be driven from the original assembly, and unexpected things will happen.

If you want to create parts that have equal dimensions, such as in the above example, but do not want to create external references, follow this procedure:

1. Create the orange disk in assembly mode.
2. Set the diameter of the disk by using **Use Edge** on the surface of the cup.
3. Bring the disk up in part mode or by using **Modify, Modify Part** and redefine the protrusion that has the external reference.
4. Break the external references by unaligning, and dimension the diameter of the disk. Pro/ENGINEER will not change the diameter of the disk, but will give it a value.
5. Now the disk has a diameter equal to the diameter of the cup, but does not reference it. The drawback of this is that if the diameter of the cup is changed, the diameter of the disk will not automatically update.
6. Add an assembly relation to set the diameter of the disk equal to that of the cup. The assembly relation will allow you to bring the disk into session in part mode and modify the diameter of the disk. The next time the disk is retrieved into the assembly, the relation will set its diameter to that of the cup.

How can external references be avoided?

- Always use default datum planes for all your parts and assemblies.
- When working on parts in assembly mode, be very careful how you dimension and reference your sketches. Always use Query Select to ensure you are dimensioning to entities on the same part.
- As of Revision 18.0, Pro/ENGINEER has a Design Manager (Design Mgr) which is available within the ASSEMBLY menu. The **Ref Control** and **Ref Viewer** menu options allow you to investigate external references and to set the scope as to how components can be referenced.
- The use of assembly relations can be an effective way to drive dimensions in assemblies without creating external relations.

External Lists

Most list items can be moved to external text files. This helps to keep the configuration files short so you can reuse list items in multiple configuration files.

The following items can be placed in external lists:

- Lists of Parameter Values
- Lists of Model Names
- Sheet Metal Bend Tables
- Drawing Format Names
- Drawing Note Heights
- Drawing Note Fonts
- Unit Lengths
- Unit Mass
- Family Table Parameters
- Required and unacceptable parameter notes
- Standard model notes
- Drawing Symbols
- Unwanted Relations

Example of lists in the configuration file:

```
PRT_PARAMETER DRAWN_BY STR EQ LIST_DESIGNERS
PRT_MODEL_NAME EQ LIST_MODEL_NAMES

LIST_DESIGNERS Damon Stoudamire
LIST_DESIGNERS Walt Williams
LIST_MODEL_NAMES block
LIST_MODEL_NAMES bolt
```

Example of lists in separate text files:

```
PRT_PARAMETER DRAWN_BY STR EQ LIST_DESIGNERS
PRT_MODEL_NAME EQ LIST_MODEL_NAMES
STD_USER_LIST_FILE designers.txt
STD_USER_LIST_FILE model_names.txt
```

The two text files would then contain the following lines:

- `designers.txt`

```
LIST_DESIGNERS Damon Stoudamire
LIST_DESIGNERS Walt Williams
```

- model_names.txt

```
LIST_MODEL_NAMES block
```

```
LIST_MODEL_NAMES bolt
```

Note: You can specify an upper limit for the number of items in the list using the `NUM_ITEMS_LONG_LIST` configuration option in the `config_init.mc` file. The default limit is 100 items.

EXTERNAL_DEPS (External Dependencies)

Y/N/E/W

Lists all the external dependencies of a model. The names of the assemblies in which the external dependencies exist are also listed. You can highlight the external dependencies.

Note: If the referenced models are not in the current session, a corresponding message appears.

Suggested Settings:

Inter	Batch	Regen	Save
Y	N	Y	N

EXTRA_LAYERS (Extra Layers)

Y/N/E/W

Lists any extra layers in the model. Extra layers are not listed in the start part.

If any are found, you can highlight the features in question in the Pro/ENGINEER window.

If the ModelUPDATE mode is enabled, this check automatically deletes the extra layers.

Suggested Settings:

Inter	Batch	Regen	Save
W	W	W	W

EXTRA_PARAMS (Extra Parameters)

Y/N/E/W

Reports extra parameters in the model. Extra parameters are not listed in the start part. If any are found, you can highlight the features in question in the Pro/ENGINEER window.

If the ModelUPDATE mode is enabled, this check automatically deletes the extra parameters.

Suggested Settings:

Inter	Batch	Regen	Save
W	W	W	W

F14_BOUND_DIST (Penetration or Distance of Boundaries)

Y/N/E/W

GeomIntegrityCHECK reports instances of penetration or contact of boundary curves caused by using values lower than the minimum distance tolerance.

Suggested Settings:

Inter	Batch	Regen	Save
E	E	N	N

F15_SURF_DIST (Proximity of a Boundary Curve to its Surface)

Y/N/E/W

In bounded surfaces, GeomIntegrityCHECK reports boundary curves with too great a distance to the surface (normal or lateral). It also reports boundary curves that extend beyond the parameter range of the surface.

Suggested Settings:

Inter	Batch	Regen	Save
E	E	N	N

F16_SIM_ORIENT (Parallel Path or Similar Orientation)

Y/N/E/W

GeomIntegrityCHECK reports boundary curves that are not parallel, because they can lead to unwanted self-penetration and face degeneration in some systems.

Suggested Settings:

Inter	Batch	Regen	Save
E	E	N	N

F17_NUM_SEG (Number of Segments in a Boundary Curve)

Y/N/E/W

GeomIntegrityCHECK reports cases of disproportionately large numbers of segments within a boundary curve.

Suggested Settings:

Inter	Batch	Regen	Save
E	E	N	N

FAMILY_INFO (Family Table Information)

Y/N/E/W

Identifies a model as either generic or not. If the model is generic, this check reports the instances with their names, and whether the instances have been successfully verified.

An instance is marked with one of the following verification states:

Successfully verified - Verified and regenerates successfully.

Unsuccessfully verified - Verified but does not regenerate successfully.

Not verified - Not verified because one or more of the following cases is true.

- The geometry of the generic model has changed after the family table was last verified.
- The instance has been modified after it was last verified.
- The instance was never verified since it was created.
- A new item has been added to the family table after the family table was last verified.

Suggested Settings:

Inter	Batch	Regen	Save
W	W	N	N

Family Table Parameter

Models with family tables can be checked to make sure that standard parameters exist in the Family Table. Use the following format in the start configuration file to designate standard family table parameters:

```
[MODE]_FT_PARAMETER [parameter]
```

where

- [MODE] is PRT or ASM.
- [parameter] is the name of the parameter that should exist in all family tables.

For example:

```
PRT_FT_PARAMETER PN
ASM_FT_PARAMETER MODELNAME
```

FEATURE_INFO (Feature Information)

Y/N

Lists the types and number of features used in the model.

Suggested Settings:

Inter	Batch	Regen	Save
Y	Y	N	N

FILE_SIZE (File Size)

Y/N

Displays the disk space that is used to store the model.

Suggested Settings:

Inter	Batch	Regen	Save
Y	Y	N	N

FORMAT_NAME (Drawing Format Name)

Y/N/E/W

Checks that the drawing format is from the standard list of acceptable formats. Standard formats are defined by the `DRW_FORMAT` start configuration option. If the drawing does not have a format, ModelCHECK prompts you to add one.

Suggested Settings:

Inter	Batch	Regen	Save
W	W	N	W

FREEFORM (Freeform Surfaces)

Y/N/E/W

Reports the number of freeform features in the model.

You can also access the Global Reference Viewer from the ModelCHECK report to view all references to and from the reported features.

Suggested Settings:

Inter	Batch	Regen	Save
Y	Y	N	N

FRZ_COMPONENTS (Frozen Components)

Y/N/E/W

Checks for frozen components in the assembly.

Suggested Settings:

Inter	Batch	Regen	Save
E	E	E	E

FT_DEF_VALS (Family Table Default Values)

Y/N/E/W

If the model has a family table, this check makes sure that no instances have default values [there are no asterisks (*) in the table].

Suggested Settings:

Inter	Batch	Regen	Save
W	W	N	N

FT_STD_PARMS (Family Table Standard Parameters)

Y/N/E/W

Ensures that the standard parameters have been added to models with family tables. Standard parameters are set in the start configuration file using the `PRT_FT_PARAMETER` and `ASM_FT_PARAMETER` configuration options.

Suggested Settings:

Inter	Batch	Regen	Save
W	W	W	W

ModelCHECK Teacher: Surface Gaps and Overlaps

Surface irregularities are most often found in models that have been imported from other CAD systems.

Why are surface gaps and overlaps dangerous?

- If you attempt to make a solid model from a quilt (a bunch of surfaces merged together), the quilt must be watertight (no gaps or overlaps)
- If you attempt to create a protrusion with **Use Quilt**, if the quilt has any gaps in it, Pro/ENGINEER will protrude to infinity through the gaps.
- Gaps and overlaps will give you problems in downstream applications such as Pro/MANUFACTURE, Pro/MOLD, and MECHANICA.

How can surface gaps and overlaps be avoided?

If you find that there are gaps and overlaps in surfaces when they are imported, try re-importing using a different accuracy.

Note: It is recommended that you use CAD/IQ to help analyze surface irregularities that ModelCHECK finds.

GEN_COMPONENTS (Generic Components)

Y/N/E/W

Reports the components in an assembly in which the generic of a family table, rather than an instance, was assembled.

You can also access the Global Reference Viewer from the ModelCHECK report to view all references to and from the reported components.

Suggested Settings:

Inter	Batch	Regen	Save
W	W	W	W

GEOM_CHECKS (Geometry Checks)

Y/N/E/W

Reports if there are any geometry checks in the model. If any are found, the features in question can be highlighted in the Pro/ENGINEER window.

You can also access the Global Reference Viewer from the ModelCHECK report to view all references to and from the reported features.

Suggested Settings:

Inter	Batch	Regen	Save
N	E	N	E

ModelCHECK Teacher: Geometry Checks

A geometry check is Pro/ENGINEER's method of warning you that there are potential regeneration or geometry problems with the model.

Although geometry checks do not always pose immediate problems to the model, it may fail to regenerate if changes are made. Therefore it is important to fix geometry checks immediately.

What causes geometry checks?

There are numerous problems that may cause geometry checks, including:

- Overlapping geometry
- Small edges
- Features that have small dimensions compared to the rest of the part
- Merged surfaces that do not exactly match
- A feature that references an edge that no longer exists in the model (that is, it was eliminated by a round)
- A round with a radius that is larger than one of the adjacent surfaces
- A feature that intersects itself
- A feature that was sketched on a drafted plane
- A section that is close to but not touching an edge

Example:

In the following example, the two cuts shown have left a small edge. It is currently not a problem, but may become one if any of the part's dimensions are changed.

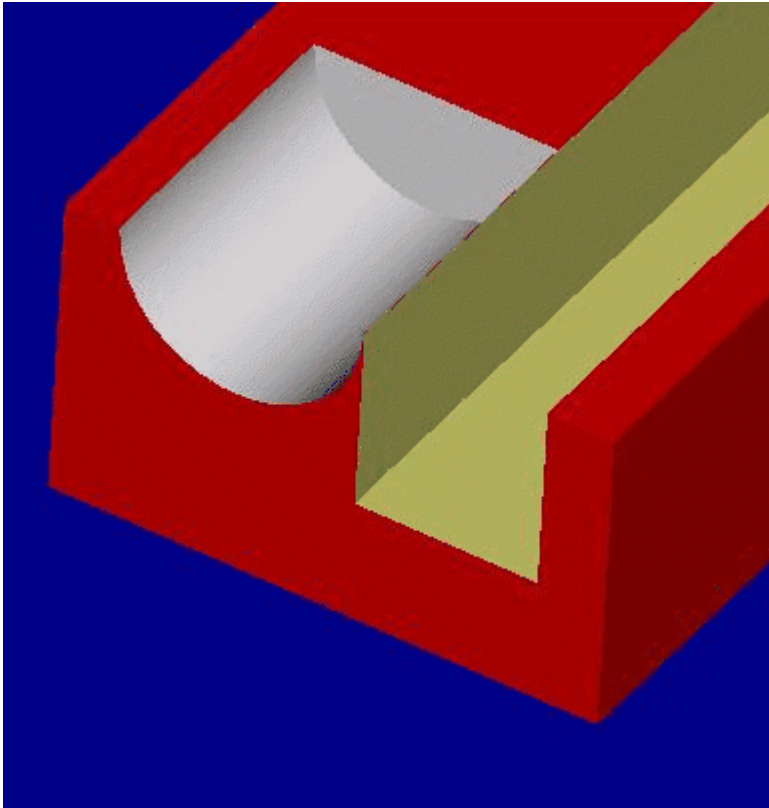

How can geometry checks be avoided?

Pro/ENGINEER checks for geometry checks on every regeneration, and reports them in the message window. It is often difficult to see the geometry checks warning because during a regeneration, the message window scrolls through many different messages.

When a geometry check is found, the **Info, Geom Check** menu pick becomes available. This menu may be used to investigate the features that are causing problems.

ModelCHECK verifies if your models contain geometry checks every time the part is saved and in batch mode.

GEOMETRIC_TOL (Geometric Tolerances)

Y/N

Reports all geometric tolerances associated with parts, assemblies, and drawings.

Suggested Settings:

Inter	Batch	Regen	Save
Y	Y	N	N

GeomIntegrityCHECK Constants

- TINY_ELMNT_TOL
- TINY_ELMNT_AREA_TOL
- TINY_DRW_ELMNT_TOL
- ID_ELMNT_TOL
- ID_DRW_ELMNT_TOL
- POS_CONT_TOL1
- TANG_CONT_TOL2
- CURV_CONT_TOL3
- POLYN_DEG_TOL
- KNOT_TOL
- SELF_DIST_TOL
- TINY_SEGMENT_TOL
- CURVATURE_RAD_TOL
- BOUND_ANGLE_MIN
- BOUND_CRV_INT_TOL
- BOUND_CRV_SRF_TOL
- NUM_SEGMENT_TOL
- KNIFE_EDGE_TOL
- DIST_VERT_EDGE_TOL
- DIST_VERT_FACE_TOL

See the topics on GeomIntegrityCHECK for information about the GeomIntegrityCHECK constants.

GLOBAL_INTF (Assembly Global Interference)

Y/N/E/W

Checks the number of days since the last global interference check was run and whether it was within the acceptable period or not.

When you run a global interference check on an assembly, ModelCHECK creates a parameter in the assembly. ModelCHECK uses the parameter the next time a report is generated to determine when the last interference check was run.

The GLOBAL_INTF_DAYS configuration option in the start configuration file sets the maximum number of days between interference checks. ModelCHECK reports whether an interference check was done recently or not.

Suggested Settings:

Inter	Batch	Regen	Save
E	E	E	E

HIGHLIGHT_COLOR

<Yellow/White/Gray/Blue/Red/Magenta/Cyan/Green/Brown>

Specifies the color used to highlight objects in Pro/ENGINEER.

Hole and Cut Diameter File

Specifies the name of the external text file in which standard hole and cut diameters are listed in the start configuration file. For example:

```
STD_HOLE_DIAM_FILE c:\apps\mc\config\text\holes.txt
```

The hole and cut diameter file has the following format:

```
# ModelCHECK Standard Hole Size File
#
UNIT INCH
.125
.25
.375
UNIT MM
2.5
3
4
4.1
```

Note: The declaration of units must be in uppercase.

HOLE_DIAMS (Standard Hole Diameters)

Y/N/E/W

Reports any holes in the model that do not have standard diameters. If any are found, you can highlight the features in question in the Pro/ENGINEER window.

You can also access the Global Reference Viewer from the ModelCHECK report to view all references to and from the reported features.

Standard hole diameters are listed in a text file specified by the `STD_HOLE_DIAM_FILE` start configuration option.

Suggested Settings:

Inter	Batch	Regen	Save
E	E	E	E

HTML_FILE_OUTPUT

<Y/N>

Creates HTML-based summary reports and writes them to the directory specified by the `DIR_REPORT` configuration option.

Note: Set this configuration option for each operating mode.

HTML_FILE_OUTPUT_REPXSL

<path>

Specifies the path to the XSL file that is used to customize the summary reports. You can use the XSL file to format the information in the XML-based reports.

HTML_MAX_DAYS

<Integer>

Specifies the maximum number of days that ModelCHECK reports are kept.

When you start Pro/ENGINEER and ModelCHECK is initialized, the directory specified by the `DIR_REPORT` configuration option is scanned for reports that are older than the specified number of days. If any are found, they are deleted.

If the `HTML_MAX_DAYS` configuration option is not specified, the purge is not done.

IGNORE_FEAT (Problem Features That Should Be Ignored)

Y/N

Sometimes it is necessary to create a feature that ModelCHECK will view as an error. ModelCHECK can be configured to ignore the problems. Problems can be set to the ignore state from any place that allows highlighting of problems. To set a problem to ignore, select the feature, type the reason for ignoring the problem in the box and click **Ignore in future**. The reason is mandatory. This information is stored in the model as a feature parameter with the name `MC_<CONFIG_TAG>`, where `CONFIG_TAG` is the name of the check.

When ModelCHECK runs on a model that contains ignored features, the ignored features are listed in the ModelCHECK report and can be highlighted. You can also see the names of the users who ignored the features and their comments. From the report, the status of the ignored features can be reset so that ModelCHECK resumes warnings about the problem.

You can also access the Global Reference Viewer from the ModelCHECK report to view all references to and from the reported features.

When ModelCHECK uses a configuration file with the IGNORE_FEAT check set to N, any ignored problems are reported as regular problems.

Suggested Settings:

Inter	Batch	Regen	Save
Y	Y	Y	Y

IGNORE_SHEETS (Sheets to Be Ignored)

Y/N/E/W

Specifies sheets that should be ignored. Use the DRW_IGNORE_SHEETS start configuration option to configure this check.

Suggested Settings:

Inter	Batch	Regen	Save
W	W	N	W

ILNK_MC_DUP_FLDR

<directory path>

Specifies the complete path to the folders that the mclchkout application must search for duplicate models.

Reuse this option up to 50 times to search more than one folder. Use a new line for every folder as follows:

- ILNK_MC_DUP_FLDR <root_dir>/<dir1>
- ILNK_MC_DUP_FLDR <root_dir>/<dir2>

ModelCHECK recursively searches the subdirectories.

ILNK_MC_PRVW_SCRIPT

<path>

Specifies the path to the Pro/INTRALINK TOOLKIT execution script (in the bin directory of the Pro/INTRALINK TOOLKIT loadpoint) to execute the mclchkout application. The mclchkout application allows duplicate models in the Pro/INTRALINK Commonsense to be previewed from the ModelCHECK report.

ILNK_MC_SRCH_SCRIPT

<path>

Specifies the path to the Pro/INTRALINK TOOLKIT execution script (in the `bin` directory of the Pro/INTRALINK TOOLKIT loadpoint) to execute the `mcilsearch` application. The `mcilsearch` application searches for duplicate models.

IMPORT_FEAT (Imported Features)

Y/N/E/W

Reports the number of imported features in the model. If any are found, you can highlight the features in question in the Pro/ENGINEER window.

You can also access the Global Reference Viewer from the ModelCHECK report to view all references to and from the reported features.

Suggested Settings:

Inter	Batch	Regen	Save
Y	Y	N	N

INCOMPLETE_FEAT (Incomplete Features)

Y/N/E/W

Reports whether any incomplete features exist in the model. If any are found, you can highlight or delete them in the Pro/ENGINEER window. ModelCHECK regenerates the model if any incomplete features are deleted.

Suggested Settings:

Inter	Batch	Regen	Save
W	E	N	E

INSERT_MODE (Insert Mode Left Active)

Y/N/E/W

Reports whether the Insert mode is active.

If this is the case, you can deactivate the Insert mode through the ModelCHECK report.

If the ModelUPDATE mode is enabled, the Insert mode is automatically deactivated.

Suggested Settings:

Inter	Batch	Regen	Save
E	E	N	E

INSTANCE_NAME (Instance Name)

Y/N/E/W

Verifies that the names of family table instances conform to the standard naming conventions defined by the PRT_INSTANCE_NAME and ASM_INSTANCE_NAME start configuration options.

This check can also be configured to verify that the names of instances begin with the same string as the generic.

Suggested Settings:

Inter	Batch	Regen	Save
E	E	W	W

INTRALINK_DUPINFO

<Y/N>

- Y - Creates read-only parameters to store the shape information for models in the Pro/INTRALINK Commonsense. ModelCHECK then searches the Pro/INTRALINK Commonsense for duplicate models.
- N - Stores the shape information for models in a place other than the Pro/INTRALINK Commonsense.

ModelCHECK Teacher: Layer Checks

Layers are a means of grouping items and then performing operations on them as a group such as displaying or blanking, plotting, selecting, and suppressing.

What ModelCHECK does with layers

- Report information - Lists all the layers and the number of items on them.
- Display status - Checks the display status of the standard named layers. If a layer is found to have the wrong display status, a **Set Status** button in the layer report will allow for automatic correction of the layer.
- Standard items - Checks that layers have the standard items on them. If items are found that are on the wrong layer, or not on any layer when they are supposed to be on a specific one, an **Add** button in the layer report will allow for automatic movement of items to their proper layers.

- Legacy layers - If configured to do so, a **Move** button in the layer report will allow you to move all items from an old or legacy layer to a new layer. ModelCHECK will then delete the old layer.

The following layers have to be in all your parts:

NAME	DISPLAY STATUS	Standard Items
AXES	BLANK	DATUM_AXIS
CSYS	BLANK	DATUM_CSYS
CURVES	BLANK	DATUM_CURVE
DATUMS	BLANK	DATUM_PLANES
ROUNDS	NONE	ROUND
DRAFT	NORMAL	DRAFT
CHAMFERS	NORMAL	CHAMFER
COSMETICS	NONE	COSMETIC_ALL

For example, the following layers will be replaced with new layers in all your parts:

OLD LAYER	NEW LAYER
DTMS	DATUM_ALL

For example, the following layers have to be in all your assemblies:

NAME	DISPLAY STATUS	Standard Items
DATUMS	BLANK	DATUM_ALL

For example, the following layers will be replaced with new layers in all your parts:

OLD LAYER	NEW LAYER
DTMS	DATUM_ALL

LAYER_DISPSTAT (Layers That Are Set to Isolate)

Y/N/E/W

Checks that no layers are stored in the Isolate mode.

Suggested Settings:

Inter	Batch	Regen	Save
W	E	N	E

LAYER_DTM_BLANK (Datum Features on Blanked Layers)

Y/N/E/W

Checks whether all datum features exist on layers (regardless of their names) and that the layers are blanked. Datum features that do not exist on layers can be highlighted.

You can also access the Global Reference Viewer from the ModelCHECK report to view all references to and from the reported features.

Suggested Settings:

Inter	Batch	Regen	Save
W	W	W	W

LAYER_EXT_ITEMS (Extra Features on Layers)

Y/N/E/W

Lists the layers containing features that do not belong to a given layer. For example, if a layer is designated as the datum plane layer and it contains features other than the datum planes, it is listed.

The extra features can be removed from the layers.

Suggested Settings:

Inter	Batch	Regen	Save
W	W	W	W

LAYER_INFO (Layer Information)

Y/N

Lists any layers found in the model and the features that are on each one.

Suggested Settings:

Inter	Batch	Regen	Save
Y	Y	N	N

LAYER_ITEMS (Items on Multiple Layers)

Y/N/E/W

Checks that features do not exist on multiple layers. If any are found, the entity IDs and their feature IDs are listed.

Suggested Settings:

Inter	Batch	Regen	Save
W	W	W	W

LAYER_MOVE (Move Items from Old Layers to New Ones and Delete the Old One)

Y/N/E/W

Note: Use this check if your standard layer configuration has changed and layers have to be updated in legacy parts (old models).

Creates a new layer, takes all items from an existing layer, moves them to a new layer, and then deletes the old layer. To use this check, both the old and new layers must be named in the start configuration file using the `PRT_LAYER_MOVE`, `ASM_LAYER_MOVE` and `DRW_LAYER_MOVE` options.

This check is available in the ModelUPDATE mode.

Suggested Settings:

Inter	Batch	Regen	Save
E	E	E	E

Layer Move

For legacy parts, ModelCHECK can create new layers, move items from old layers to the new ones, and delete the old layers. Use the following format in the start configuration file to set up a change in layers:

```
[MODE]_LAYER_MOVE [old_layer] [new_layer]
```

where

- [MODE] is PRT, ASM, or DRW.
- [old_layer] is the name of the old layer.
- [new_layer] is the name of the new layer.

For example:

```
PRT_LAYER_MOVE DTMS DATUMS
PRT_LAYER_MOVE CSYS DATUMS
```

A layer called `DATUMS` will be created in the model, all features from the `DTMS` and `CSYS` layers will be moved to the `DATUMS` layer, and the `DTMS` and `CSYS` layers will be deleted.

LAYER_PLACE (Layers Contain Standard Items)

Y/N/E/W

Checks whether the standard layers contain the standard features. If any items are found on wrong layers, you can have ModelCHECK automatically move them on to correct ones.

Standard features include:

- axes
- chamfers
- components
- cosmetic grooves
- cosmetic sketches
- cosmetic threads
- coordinate systems
- curves
- cuts
- datums
- datum axes
- datum coordinate systems
- datum planes
- datum points
- datum quilts
- datum surfaces
- drafts
- draft lines
- groups
- geometric tolerances
- holes
- notes
- protrusions

- rounds
- shells
- slots
- symbols
- threads

The `PRT_LAYER` and `ASM_LAYER` start configuration options define standard layers.

If the ModelUPDATE mode is enabled, this check automatically moves items on wrong layers to the correct layers and moves items that are not placed on any layer to the appropriate layers.

Suggested Settings:

Inter	Batch	Regen	Save
W	E	N	E

LAYER_STATUS (Layer Status)

Y/N/E/W

Checks the display status of the standard named layers. If any layers are not saved in the right display status, you can have ModelCHECK automatically correct them. The `PRT_LAYER` and `ASM_LAYER` start configuration options define standard layers.

If the ModelUPDATE mode is enabled, this check automatically updates the display status of the standard named layers.

Suggested Settings:

Inter	Batch	Regen	Save
W	E	N	E

LAYER_UNWANTED (Unwanted Layers)

Y/N

Checks for unwanted layers and deletes them. Unwanted layers are specified in the start configuration file using the `PRT_LAYER_UNWANTED`, `ASM_LAYER_UNWANTED`, and `DRW_LAYER_UNWANTED` start configuration options.

Layers

ModelCHECK can do the following:

- Check the display status of layers.
- Find standard layers and check their status settings. If the status of a layer is not set correctly, ModelCHECK can change it at your request.

ModelCHECK - Help Topic Collection

- Check the features on a layer.
- Find certain features on specific layers. If a standard layer does not have all expected features, ModelCHECK can incorporate them as requested.

Use the following format in the start configuration file to configure layers:

```
[MODE]_LAYER [layer] [layer_status] [entity_type]
```

where

- [MODE] is PRT, ASM or DRW.
- [layer] is the name of the layer.
- [layer_status] is the layer display status. Acceptable values are:
 - BLANK - Layer is blanked.
 - DISPLAY - Layer is isolated. It is the only layer shown; all the other layers are blanked.
 - NORMAL - Layer is shown.
 - NONE - Layer maintains the previously set display status.
- [entity_type] is the entity type. Leave blank if there are no standard items for the layer in question. The acceptable values are listed in the next table.

AXIS	CHAMFER	COMPONENT	COSMETIC
COSMETIC_ALL	COSMETIC_GROOVE	COSMETIC_SKETCH	COSMETIC_THREAD
CSYS	CURVE	CUT	DATUM
DATUM_AXIS	DATUM_CSYS	DATUM_PLANES	DATUM_POINT
DATUM_QUILT	DATUM_SURF	DRAFT	DRAFT_LINE
GROUPS	GTOLS	HOLE	NOTES (DRW)
PROTRUSION	ROUND	SHELL	SLOT
SYMBOLS (DRW)	THREAD		

Note: CSYS and DATUM_CSYS can be interchangeably used. AXIS is the axis of any feature while DATUM_AXIS is specifically used as a reference for feature creation.

For example:

```
PRT_LAYER DEFAULT_DATUMS NONE LIST_DEF
PRT_LAYER DATUM_PLANES BLANK DATUM_PLANES
PRT_LAYER AXES BLANK DATUM_AXIS
PRT_LAYER CSYS BLANK DATUM_CSYS
PRT_LAYER ROUNDS NONE ROUND
PRT_LAYER COSMETICS NORMAL COSMETIC_ALL
```

Feature names can be listed as entity types using a named list as `LIST_XXX` where `XXX` is the name of the list used. For example, to specify that default datums must go on a layer called `DEFAULT_DATUMS`, use the following syntax:

```
PRT_LAYER DEFAULT_DATUMS NONE LIST_DEF EXCLUSIVE
```

Then create a list of datum names to include on this layer (create this list either in the start configuration file or in an external file referenced by the start configuration file):

```
LIST_DEF DTM1
LIST_DEF DTM2
LIST_DEF DTM3
LIST_DEF CSYS_0
```

If `EXCLUSIVE` is added to the end of the line, ModelCHECK ignores the listed features in the rules set for other layers.

Lines that use the `EXCLUSIVE` option should be placed before lines that are not exclusive in the configuration files.

Extra Layers

Layers in the model that are not listed as start items can be reported as extra layers. ModelCHECK lists extra layers that you can delete from the model. This check is configured in the check configuration file as follows:

```
EXTRA_LAYERS YNEW W W N N Y
```

Sub-Layers

Layers can be specified to have a standard list of sub-layers (other layers) on them. To set this up, use the following line:

```
PRT_LAYER LAYER_NAME BLANK LIST_LAYERS
```

where `LIST_LAYERS` is a list containing the names of the layers to be on `LAYER_NAME`.

The `LIST_LAYERS` list needs to have each layer name specified with the prefix of `LAYER_` as follows:

```
LIST_LAYERS LAYER_DATUM_PLANES
LIST_LAYERS LAYER_DATUM_CSYS
```

LAYOUT_INFO (Layout Information)

Y/N/E/W

Lists layouts associated with the model.

Suggested Settings:

Inter	Batch	Regen	Save
Y	Y	N	N

Length Units

The length units of the model can be checked and verified as being from an acceptable list. These units are configured in the start configuration file as shown in the following example:

```
PRT_UNITS_LENGTH INCH
PRT_UNITS_LENGTH MM
```

LOW_TOLERANCE (Lowest Allowable Tolerance)

Y/N/E/W

Reports the dimensions in the model in which the tolerance is lower than the standard minimum value. If any are found, you can highlight the features in question in the Pro/ENGINEER window.

The minimum allowable tolerance is set using the `MIN_TOLERANCE` constant configuration option.

Suggested Settings:

Inter	Batch	Regen	Save
E	E	E	E

M1_TINY_ELMNT (Tiny Elements)

Y/N/E/W

- In wire geometry, `GeomIntegrityCHECK` reports the elements in your model that are smaller than specified in your configuration files.
- In surfaces, `GeomIntegrityCHECK` reports the faces and face patches whose length in at least two opposing directions is smaller than specified in your configuration file.
- `GeomIntegrityCHECK` reports bounded surfaces that are smaller than specified in your configuration file.
- `GeomIntegrityCHECK` reports the solids whose expansion in two spatial directions is smaller than specified in your configuration file.
- `GeomIntegrityCHECK` reports the drawing elements that are smaller than specified in your configuration file.

Suggested Settings:

Inter	Batch	Regen	Save
E	E	N	N

M2_IDENTICAL_ELMNT (Identical Elements)

Y/N/E/W

GeomIntegrityCHECK reports those wire, surface, and drawing elements that are identical to other elements in the same model.

Suggested Settings:

Inter	Batch	Regen	Save
E	E	N	N

M3B_TANG_CONT (Tangential Continuity)

Y/N/E/W

- In wire geometry, GeomIntegrityCHECK reports the curve segments or curves whose tangential angles exceed the configuration angle value.
- In surfaces, GeomIntegrityCHECK measures and compares tangential angles of two segments along a common border. If the maximum difference among the angles exceeds the configuration angle tolerance, the affected segment boundary is reported.
- In topologies, the tangency angle or normal angles of two faces in a common boundary curve are checked at several points. If the angle difference exceeds the configuration angle tolerance, GeomIntegrityCHECK reports the affected boundary curve.

Suggested Settings:

Inter	Batch	Regen	Save
E	E	N	N

M3A_POSITION_CONT (Position Continuity)

Y/N/E/W

- In wire geometry, GeomIntegrityCHECK reports discontinuities in curve and curve-segment transition points that exceed the configuration tolerance.
- GeomIntegrityCHECK checks individual bounded surfaces and their segments for continuity in position, gradient, and curvature at several points. It reports discontinuities.
- In topologies, GeomIntegrityCHECK checks at several points the parity of two common boundary curves. If the gap between the curves exceeds the configuration tolerance, GeomIntegrityCHECK reports the affected face boundary.

Suggested Settings:

Inter	Batch	Regen	Save
E	E	N	N

M3C_CURV_CONT (Curvature Continuity)

Y/N/E/W

- In wire geometry, GeomIntegrityCHECK measures the curvature radii in curves and curve segments. It reports the curves and curve segments where the relative difference of the radii exceeds the configuration curvature tolerance.
- In surfaces, GeomIntegrityCHECK checks the curvature radii of two segments at several points along the common border. If the maximum relative curvature difference is greater than the configuration curvature tolerance, the affected segment boundary is reported.
- In topologies, GeomIntegrityCHECK checks the curvature radii of two faces at several points in a common boundary curve. If the relative curvature difference exceeds the configuration curvature tolerance, the affected boundary curve is reported.

Suggested Settings:

Inter	Batch	Regen	Save
E	E	N	N

M4_POLYN_DEG (Polynomial Degree)

Y/N/E/W

- In wire geometry and drawings, GeomIntegrityCHECK reports the curves whose polynomial degrees exceed the upper limit specified in your configuration file.
- GeomIntegrityCHECK reports the surfaces where the polynomial degree in at least one parameter direction exceeds the upper limit specified in your configuration file.

Suggested Settings:

Inter	Batch	Regen	Save
E	E	N	N

M5_WAVINESS (Waviness)

Y/N/E/W

Reports wavy curves and surfaces.

Suggested Settings:

Inter	Batch	Regen	Save
E	E	N	N

M6_KNOT_DIST (Knot Distance)

Y/N/E/W

Reports the curves and faces having a knot clearance that is lower than the specified tolerance value.

Suggested Settings:

Inter	Batch	Regen	Save
E	E	N	N

Mass Units

The mass units of the model can be checked and verified as being from an acceptable list. These are configured in the start configuration file as shown in the following example:

```
PRT_UNITS_MASS KILOGRAM
ASM_UNITS_MASS POUND
```

Note: The units must be specified in uppercase and spelled as shown.

MATERIAL_INFO (Material Type)

Y/N/E/W

Reports whether the model's material has been defined or not. If it has, its name is reported. This check also verifies that the defined material comes from an acceptable list. Standard material names are listed in the start configuration file using the `MATERIAL_NAME` configuration option.

If the ModelUPDATE mode is enabled and a material has not been assigned to a model, this check updates the model by automatically assigning a material from the material library. You must specify a location for the material library using the `pro_material_dir` configuration option in the Pro/ENGINEER `config.pro` file.

Suggested Settings:

Inter	Batch	Regen	Save
W	W	N	W

Material Name

The material name can be checked and verified as being from an acceptable list. This option is configured in the start configuration file as shown in the following example:

```
MATERIAL_NAME STEEL  
MATERIAL_NAME ALUMINUM
```

You can update the material from the ModelCHECK report. To do this, a valid material file having the `.mtl` extension must exist in either the working directory or in the location specified by the `pro_material_dir` configuration option in the `config.pro` file.

MAX_ABS_ACCURACY

Defines the maximum acceptable value for a model's absolute accuracy. This is only used if the model's accuracy is set to absolute.

MAX_DRAW_SHEETS

This defines the maximum number of drawing sheets allowed.

MAX_SKETCH_ITEMS

Defines the maximum number of entities allowed in a sketched feature.

MC_AUTHORIZATION_FILE

<Y/N>

Specifies whether an external text file (`external_access.txt`) is used to control access to the ModelCHECK configuration files.

Note: The `external_access.txt` file is used only if you have set the `MCDIR` environment variable is set. This file is located in the `text` subdirectory in the `config` directory specified by the `MCDIR` environment variable.

MC_ENABLE

<Y/N/A>

- Y - Enables ModelCHECK all the time.
- N - Disables ModelCHECK.
- A - Prompts you when Pro/ENGINEER starts whether to enable ModelCHECK or not.

MC_METRICS

<Y/N>

Specifies whether ModelCHECK must generate metrics files for use in the metrics package.

Note: Set this configuration option for each operating mode.

MC_VDA_RUN

<Y/N>

Runs the GeomIntegrityCHECK utility along with ModelCHECK in all the ModelCHECK operating modes.

Note: Set this configuration option for each operating mode.

MCREGEN_VERIFY_FT_INSTS

<Y/N>

Verifies all instances during **ModelCHECK Regenerate** if the assembly is a generic representative of a family. The default is N.

Note: This configuration option is applicable only in Interactive mode and for assemblies.

MCSI1_TOL

Defines the tolerance value, as a percentage, for the volume of a model. ModelCHECK uses this value to search for duplicate models. The largest allowable value is 0.1, that is, 10%.

MCSI2_TOL

Defines the tolerance value, as a percentage, for the surface area of a model. ModelCHECK uses this value to search for duplicate models. The largest allowable value is 0.1, that is, 10%.

MCSI3_TOL

Defines the tolerance value, as a percentage, for the first principal moment of inertia of a model. ModelCHECK uses this value to search for duplicate models. The largest allowable value is 0.1, that is, 10%.

MCSI4_TOL

Defines the tolerance value, as a percentage, for the second principal moment of inertia of a model. ModelCHECK uses this value to search for duplicate models. The largest allowable value is 0.1, that is, 10%.

MCSI5_TOL

Defines the tolerance value, as a percentage, for the third principal moment of inertia of a model. ModelCHECK uses this value to search for duplicate models. The largest allowable value is 0.1, that is, 10%.

MEMORY_SPACE (Memory Space Used)

Y/N

Displays the memory space used while the model is in session. This check is available only in Batch mode.

Suggested Settings:

Inter	Batch	Regen	Save
N	Y	N	N

ModelCHECK Teacher: Merged and Cutout Features

In the assembly mode, it is possible to add or subtract the material of one set of parts to or from another set of parts that are in the same assembly. When this is done, a new feature called a merge or cutout is added to each of the parts to which the action was performed.

Why are merged and cutout features dangerous?

If the merge or cutout was created using the Reference option (rather than copy), the new feature will depend on the parts that it references. This means that when retrieving the part with the merge or cutout feature, Pro/ENGINEER will have to retrieve all the reference parts into session in order to re-create the merge. This means that the reference parts have to always reside somewhere where Pro/ENGINEER can find them.

To create a merge or cutout feature without any external references or dependencies, use the Copy option. This will add a new feature to all the parts, but will break all association with the reference parts.

If you often reuse parts in different assemblies, it is not recommended that you use a Reference Merge or Cutout. You will find that many of your parts will become overloaded with external references, and it will become a nightmare to manage all of your models.

MERGE_FEAT (Merged Features)

Y/N/E/W

Lists the features that have been merged or cut out in Assembly mode. If any are found, you can highlight them in the Pro/ENGINEER window.

You can also access the Global Reference Viewer from the ModelCHECK report to view all references to and from the reported features.

Suggested Settings:

Inter	Batch	Regen	Save
E	E	E	E

MIN_ABS_ACCURACY

Defines the minimum acceptable value for a model's absolute accuracy. This option is only used if the model's accuracy is set to absolute.

MIN_TOLERANCE

Specifies the maximum allowable dimensional tolerance in a model.

MINMAXTOL_INFO (Minimum and Maximum Tolerances)

Y/N

Reports the minimum and maximum linear tolerance used in the model. You can highlight the minimum and maximum tolerances in the Pro/ENGINEER window.

Suggested Settings:

Inter	Batch	Regen	Save
Y	Y	Y	Y

MIS_COMPONENTS (Missing Components)

Y/N/E/W

Reports missing components. These occur when Pro/ENGINEER does not know where a component, needed for an assembly, can be found on the disk.

Suggested Settings:

Inter	Batch	Regen	Save
E	E	E	E

MODE_RUN

<Y/N>

Specifies the operating mode in which ModelCHECK will run. Set to Y to run and to N to turn ModelCHECK off in each mode.

MODE_UPDATE

<Y/N>

Sets ModelCHECK to allow updating of wrong items or adding missing items according to the settings in the start configuration file.

Note: This configuration option is used only in Batch mode. Corrections are automatically made to models and the models are saved.

MODEL_NAME (Model Name Specification Errors)

Y/N/E/W

Verifies that the names of parts and assemblies conform to the standard naming conventions defined by the PRT_MODEL_NAME and ASM_MODEL_NAME start configuration options.

Suggested Settings:

Inter	Batch	Regen	Save
E	E	W	W

Model Name

ModelCHECK can verify that Pro/ENGINEER model names, instances, and simplified representations conform to company-specific naming standards in the following ways:

- Are file names less than, equal to, or greater than a specific number of characters?
- Do file names consist of only characters or only numbers?
- Do file names contain specific strings?

Use the following format in the start configuration file to configure layers:

```
[MODE]_[MOD_INST]_NAME [equality] [value]
```

where

- [MODE] is PRT, ASM, or DRW.
- [MOD_INST] is MODEL, INSTANCE or SIMPREP.
- [equality] is the equality relationship. Acceptable values are:
 - EQ - Equal to
 - NEQ - Not equal to
 - LT - Less than (only for length)
 - GT - Greater than (only for length)

- LTE - Less than or equal to (only for length)
- GTE - Greater than or equal to (only for length)
- [value] is the value of the model name. Rules for values are:
 - Do not specify exact values, because each Pro/ENGINEER model has to have a different name.
 - Use ALL_CHARACTERS to verify that all models have names that consist only of characters. This check ignores dashes (-) or underscores (_) found in names.
 - Use ALL_NUMBERS to verify that all models have names that consist of only numbers. This check ignores dashes (-) or underscores (_) found in names.
 - Use LENGTH_## where ## is a number. This check verifies that the number of characters in model names is either less than, less than or equal to, equal to, greater than, or greater than or equal to a specific number.
 - *, ?, # and \$ can be used as wildcards, where:
 - * - Any number of characters
 - ? - One character (numerical, alphabetical, or symbol)
 - # - One numerical character
 - \$ - One string character
 - For DRW_MODEL_NAME, a value of FIRST_MODEL can be specified if you want to check that the name of the drawing is the same as the first model added to the drawing.
 - Specify LIST_XXX to refer to a list of acceptable values.

```
PRT_MODEL_NAME EQ LIST_NAMES
```

Specify each member of the LIST_NAMES list on a separate line in the configuration file as follows:

```
LIST_NAMES CE_*
LIST_NAMES CD_*
LIST_NAMES EO_*
```

This check would verify that all model names begin with CE_, CD_ or EO_. Alternatively, you can refer to a text file that contains the list, as follows:

```
LIST_NAMES text/list.txt
```

For example:

```
PRT_MODEL_NAME EQ ALL_CHARACTERS
PRT_MODEL_NAME EQ ALL_NUMBERS
PRT_MODEL_NAME EQ LIST_NAMES
PRT_INSTANCE_NAME EQ XYZ_*
PRT_INSTANCE_NAME EQ GENERIC
```

ModelCHECK - Help Topic Collection

```
ASM_MODEL_NAME LT LENGTH_12
ASM_INSTANCE_NAME EQ E_##_*
DRW_MODEL_NAME EQ CD_*
DRW_MODEL_NAME EQ ???_CD
DRW_MODEL_NAME EQ FIRST_MODEL
```

Examples of wildcards:

- `*test` - The value has to end in `test`, so `model test` would be an acceptable value.
- `??-??` - The value has to be five characters long with a hyphen (-) as the third character.
- `####-$000` - The first four characters have to be numbers, the fifth character has to be a dash (-), character number 6 has to be a letter, and the last 3 characters have to be zeros (0).
- `???_*` - The first three characters can be any characters followed by an underscore.

MODEL_NAME_STR (Model Name)

Y/N

Reports the name of the model. This check primarily creates a parameter that stores the name of the model. This is done using the `ADD_CHK_PARAM` start configuration option.

Suggested Settings:

Inter	Batch	Regen	Save
Y	Y	N	N

Model Parameters

Parameters to be added to a model can be specified. Use the following format in the start configuration file to list the parameters to add to the model:

```
[MODE]_ADD_CHK_PARAM [parameter] [check_output]
```

where

- `[MODE]` is `PRT`, `ASM`, or `DRW`.
- `[parameter]` is the name of the parameter to be created.
- `[check_output]` is the name of the check whose output is to be used.

For example,

```
PRT_ADD_CHK_PARAM MATERIAL MATERIAL_INFO
PRT_ADD_CHK_PARAM UNITS_LENGTH UNITS_LENGTH
PRT_ADD_CHK_PARAM MODEL_NAME MODEL_NAME_STR
```

MODELS_USED (Models Used in a Drawing)

Y/N

Lists the models used in a drawing.

Suggested Settings:

Inter	Batch	Regen	Save
Y	Y	N	N

MU_ENABLED

<Y/N>

Enables or disables the ModelUPDATE mode.

MU_REGENERATE

<Y/N>

Regenerates the model after ModelUPDATE is complete.

NAMED_FEAT (Named Features)

Y/N

Reports the number of features that are named in parts and assemblies and calculates them as a percentage of all the features in the model. The check also lists the names of these features.

Suggested Settings:

Inter	Batch	Regen	Save
Y	Y	N	N

Unwanted Layers for ModelUPDATE

You can specify the names of unwanted layers. ModelUPDATE removes the unwanted layers if configured to do so in the `LAYER_UNWANTED` check. Use the following format in the start configuration file:

```
PRT_LAYER_UNWANTED [layer]
ASM_LAYER_UNWANTED [layer]
DRW_LAYER_UNWANTED [layer]
```

Unwanted Parameters for ModelUPDATE

You can specify the names of unwanted parameters. ModelUPDATE removes the unwanted parameters if configured to do so in the `PARAM_UNWANTED` check. Use the following format in the start configuration file:

```
PRT_PARAM_UNWANTED [parameter]
ASM_PARAM_UNWANTED [parameter]
DRW_PARAM_UNWANTED [parameter]
```

NOTE_CASE (Note Case)

Y/N/E/W

Reports notes in lowercase in a model. You can highlight the notes and change them to uppercase.

Note: This check does not consider notes that have more than 255 characters.

Suggested Settings:

Inter	Batch	Regen	Save
W	W	N	W

NOTE_FONT (Note Fonts)

Y/N/E/W

Reports any drawing notes using a font that is not from the list of approved fonts. Approved fonts are specified in the start configuration file using the `DRW_NOTE_FONT` configuration option.

Note: This check does not consider notes that have more than 255 characters.

Suggested Settings:

Inter	Batch	Regen	Save
E	E	W	W

NOTE_HEIGHT (Note Height)

Y/N/E/W

Reports any drawing notes with text that is not from the list of approved sizes. Approved sizes are specified in the start configuration file using the `DRW_NOTE_HEIGHT` configuration option.

Note: This check does not consider notes that have more than 255 characters.

Suggested Settings:

Inter	Batch	Regen	Save
E	E	W	W

NOTE_INFO (Drawing Note Information)

Y/N

Lists notes in the drawing with the sheets they are on.

Note: This check does not consider notes that have more than 255 characters.

Suggested Settings:

Inter	Batch	Regen	Save
Y	Y	N	N

NOTE_SPELL (Note Spelling Errors)

Y/N/E/W

Checks the drawing for spelling mistakes. If any mistakes are found you can highlight them or highlight and correct them. Also, you can add the word to the dictionary so that ModelCHECK accepts it as correct.

Note: This check does not consider notes that have more than 255 characters.

Suggested Settings:

Inter	Batch	Regen	Save
E	E	W	E

NOTE_UNACCEPT (Unacceptable Notes)

Y/N/E/W

Verifies that no unacceptable text exists in any drawing notes or tables.

Unacceptable text is defined in the start configuration file with the `DRW_NOTE_UNACC` configuration option.

Note: This check does not consider notes that have more than 255 characters.

Suggested Settings:

Inter	Batch	Regen	Save
E	E	W	W

NUM_COMPONENTS (Number of Components)

Y/N

Reports the total number of components in an assembly.

Suggested Settings:

Inter	Batch	Regen	Save
Y	Y	N	N

NUM_DRAW_SHEETS (Maximum Number of Drawing Sheets)

Y/N/E/W

Counts the number of sheets in a drawing and verifies that the number does not exceed the maximum.

The maximum allowed is set using the MAX_DRAW_SHEETS configuration option in the constant configuration file.

Suggested Settings:

Inter	Batch	Regen	Save
E	E	N	E

NUM_ITEMS_LONG_LIST

<Integer>

Specifies the maximum number of items that a list can contain. If the number of items in the list exceeds the limit, ModelCHECK does not display the list in the report and you cannot update any values which refer to the list. The default limit is 100 items.

OVERALL_SIZE (Overall Size)

Y/N

Reports the length, width, and height of a box that would fit around the model.

Suggested Settings:

Inter	Batch	Regen	Save
Y	Y	N	N

OVERLAP_INFO (Overlap Information)

Y/N/E/W

Checks for overlapping views in the drawing. If any are found, the features in question can be highlighted in the Pro/ENGINEER window.

Suggested Settings:

Inter	Batch	Regen	Save
W	W	W	W

ModelCHECK Teacher: Parameter Information

A parameter is a value that can be attached to a Pro/ENGINEER model which contains non geometric information on the model. For example, part numbers or the name of the designer can be stored in parameters.

Types of Parameters used by ModelCHECK

- Parameters - ModelCHECK verifies that the model contains a standard set of parameters. If they are not there, you can use the **Update Parameters** and **Layers** button from Netscape to add the missing parameters to your model. A second option is to use **Set Up, Parameters, Create** to add the missing parameters from within Pro/ENGINEER.

For example, the following parameters have to be in all your parts:

- MODEL

For example, the following parameters have to be in all your assemblies:

- DRAWN_BY
- MATERIAL
- DESCRIPTION

- PDM parameters - Parameters can be designated specifically for use in PDM. This means that when the model is submitted into PDM, these parameters can be extracted as attributes and submitted into the database.

To designate a parameter, use the following menu picks: **Set Up, Parameters, Designate, Parameters**, then pick the parameters to designate. The parameters must already exist in the model.

For example, the following PDM-designated parameters have to be in all your parts:

- PN

For example, the following PDM designated parameters have to be in all your assemblies:

- PN
- NULL parameters - NULL parameters are parameters that have been assigned to a model but have not been given a value. To add a value to a parameter, select **Set Up, Parameters, Modify**, and select the parameter.

For example, the following parameters have been designated as null in parts:

- EMPTY
- PN

For example, the following parameters have been designated as null in assemblies:

- DRAWN_BY
- MATERIAL
- DESCRIPTION
- Parameters used in drawings - Note and table information in a drawing can be driven by model parameters. An effective way to do this is to create a drawing format. This information is then available each time the format is used.

PACK_COMPONENTS (Packaged Components)

Y/N/E/W

Reports any components that are not fully constrained or that are packaged.

Suggested Settings:

Inter	Batch	Regen	Save
E	E	W	W

PARAM_INFO (Model Parameters)

Y/N

Lists all parameters in the model and their values.

Suggested Settings:

Inter	Batch	Regen	Save
Y	Y	N	N

PARAM_MAP (Parameter Mapping)

Y/N

Enables mapping the contents of one parameter to another parameter and deletes the first one, thus facilitating renaming of parameters. The parameters are specified in the start configuration file using the `PRT_PARAM_MAP`, `ASM_PARAM_MAP`, and `DRW_PARAM_MAP` start configuration options.

PARAM_NOTE_REQ (Required Parameter Notes)

Y/N/E/W

Checks that required parameter notes are present. Notes can be checked in the following way:

- Does a specific parameter exist and does it contain the required text?

Required parameter notes are designated in the start configuration file using the `PRT_PARAM_NOTE_REQ` and `ASM_PARAM_NOTE_REQ` configuration options.

All note text is stored in external text files.

Suggested Settings:

Inter	Batch	Regen	Save
W	W	N	N

PARAM_NOTE_UNACC (Unacceptable Parameter Notes)

Y/N/E/W

Checks and marks the unacceptable parameter notes. Notes can be checked in the following way:

- Does a specific parameter exist and does it contain any unacceptable text?

Unacceptable parameter notes are designated in the start configuration file using the `PRT_PARAM_NOTE_UNACC` and `ASM_PARAM_NOTE_UNACC` configuration options.

All note text is stored in external text files.

Suggested Settings:

Inter	Batch	Regen	Save
W	W	N	N

PARAM_RENAME (Parameter Rename)

Y/N/E/W

If this check is enabled, ModelCHECK can rename a specified parameter. Parameters to be renamed are specified using the `PRT_PARAM_RENAME` and `ASM_PARAM_RENAME` start configuration options.

Suggested Settings:

Inter	Batch	Regen	Save
W	W	W	W

PARAM_SPELL (Parameter Spelling)

Y/N/E/W

Checks that parameter values have been spelled correctly. If any are spelled incorrectly, you can correct the spelling or add the value to the dictionary.

Suggested Settings:

Inter	Batch	Regen	Save
W	W	N	N

PARAM_UNUSED (Unused Parameters)

Y/N/E/W

Reports part parameters that are unused in relations and in family tables. It also allows deletion of these unused parameters.

If the ModelUPDATE mode is enabled, this check automatically deletes part parameters that are unused in relations and in family tables.

Suggested Settings:

Inter	Batch	Regen	Save
W	N	W	N

PARAM_UNWANTED (Unwanted Parameters)

Y/N

Checks for unwanted parameters and deletes them. Unwanted parameters are specified in the start configuration file using the `PRT_PARAM_UNWANTED`, `ASM_PARAM_UNWANTED`, and `DRW_PARAM_UNWANTED` start configuration options.

PARAMCHECK (Parameter Format Errors)

Y/N/E/W

Checks that all standard parameters are present in the model and that they are of an acceptable type and format.

Standard parameters are defined by the `PRT_PARAMETER` and `ASM_PARAMETER` start configuration options.

If the ModelUPDATE mode is enabled, this check automatically corrects the type and value of parameters, if required.

Suggested Settings:

Inter	Batch	Regen	Save
E	E	W	W

Parameter Mapping for ModelUPDATE

In the ModelUPDATE mode, ModelCHECK can map the contents of an existing parameter to a new or existing parameter, and delete the first one, thus facilitating renaming of parameters. Use the following format in the start configuration file to map parameters:

```
[MODE]_PARAM_MAP [parameter_1] [parameter_2]
```

where

[MODE] is PRT, ASM, or DRW.

[parameter_1] is the parameter whose contents are mapped.

[parameter_2] is the parameter to which the contents of parameter_1 are mapped.

For example:

```
PRT_PARAM_MAP GAVIN FINN
```

Given the above configuration options, if ModelUPDATE finds a parameter called GAVIN, it maps the contents to a parameter called FINN and deletes GAVIN.

Parameter Rename

ModelCHECK can rename parameters from old names to new ones while preserving their values. Use the following format in the start configuration file to rename parameters:

```
[MODE]_PARAM_RENAME [old_name] [new_name]
```

where

- [MODE] is PRT, ASM, or DRW.
- [old_name] is the current name of the parameter.
- [new_name] is the new name of the parameter.

For example:

```
PRT_PARAM_RENAME GAVIN FINN
ASM_PARAM_RENAME WAYNE HOLDEN
```

Given the above configuration options, when you run ModelCHECK on a part or an assembly, if it finds a parameter called `GAVIN`, it allows you to rename it to `FINN`.

Parameters

ModelCHECK includes a parameter check that verifies that the model parameters conform to your company standards. The following information can be verified in parameters:

- Are they the right types (string, integer, real, Boolean)?
- Are they PDM designated?
- Do they have assigned values?
- Do specific parameters have values from a standard list of valid values?
- Are numerical parameters less than, greater than, or equal to a specific value?
- Are string or Boolean parameters equal to a specific value?
- Do string parameters contain specific letters, or are they a specific length?

Use the following format in the start configuration file to rename parameters:

```
[MODE]_PARAMETER [name] [type] [equality] [value]
```

where

- `[MODE]` is PRT, ASM, or DRW.
- `[name]` is the name of the parameter. The name is not case-sensitive.
- `[type]` is the type of the parameter. The following values are acceptable:
 - STR - String value
 - BOOL - Boolean value (Yes / No)
 - INTEGER - Integer value
 - REAL - Real value
 - NONE - No standard type
- `[equality]` is the equality. The following values are acceptable:
 - EQ - Equal to a value or a list of values
 - NEQ - Not equal to a value or a list of values
 - LT - Less than
 - GT - Greater than

- LTE - Less than or equal to
- GTE - Greater than or equal to
- [value] is the value. The value is case-sensitive. The following values are applicable:
 - The exact value can be specified, or a number can be given for less-than or greater-than checks.
 - PDM can be specified if the parameter is supposed to be PDM designated.
 - NULL can be specified if the parameter does not have an assigned value.
 - *, ?, # and \$ can be used as wildcards, where
 - * - Any number of characters
 - ? - One character (numerical, alphabetical, or symbol)
 - # - One numerical character
 - \$ - One string character

Note: You cannot use wildcards with parameters of type REAL.

- LIST_XXX can be specified where XXX is the name of a list of acceptable values.

```
PRT_PARAMETER DRAWN_BY STR EQ LIST_DESIGNERS
```

Specify each member of the list on a separate line in the start configuration file:

```
LIST_DESIGNERS Michael Jordan
LIST_DESIGNERS Grant Hill
LIST_DESIGNERS Penny Hardaway
```

This list would allow the three names as acceptable values for the given parameter.

For example:

```
PRT_PARAMETER MODEL STR EQ circ
PRT_PARAMETER PN NONE EQ PDM
PRT_PARAMETER PN NONE EQ ????-???
PRT_PARAMETER COMPANY STR EQ PTC
PRT_PARAMETER EMPTY NONE EQ NULL
PRT_PARAMETER DRAWN_BY STR EQ LIST_DESIGNERS
PRT_PARAMETER RELEASED BOOL EQ YES
PRT_PARAMETER DRAFT_ANGLE REAL LTE 5
PRT_PARAMETER DESCRIPTION STR EQ *test
PRT_PARAMETER MATERIAL STR EQ PDM
PRT_PARAMETER RC_MODEL_TYPE STR EQ LIST_MODEL_TYPE
PRT_PARAMETER ENG_PRJ_NO STR EQ PDM
PRT_PARAMETER DEPARTMENT STR LTE LENGTH_12
```

ModelCHECK - Help Topic Collection

```
PRT_PARAMETER MASS REAL
PRT_PARAMETER VOLUME REAL
PRT_PARAMETER MC_INT INTEGER EQ 12345
PRT_PARAMETER MC_REAL REAL EQ 5.33
```

Wildcard examples:

- *test - The value has to end in test, so `model test` would be an acceptable value.
- ??-?? - The value has to be five characters long with a hyphen (-) as the third character.
- ####-\$000 - The first four characters have to be numbers, the fifth character has to be a dash (-), character number 6 has to be a letter, and the last 3 characters have to be zeros.

Note: Parameters in the model that are not listed as start items can be reported as extra parameters by setting the EXTRA_PARAMS check in the check configuration file. ModelCHECK lists extra parameters and you can delete them from the model.

PARAMS_EXIST (Drawing Parameters)

Y/N/E/W

Checks for drawing parameters in the model. In some Pro/ENGINEER installations, all parameters must be driven from the model, so drawing parameters are highlighted as problems.

Suggested Settings:

Inter	Batch	Regen	Save
E	E	E	E

PARAMS_USED (Drawing Parameters Used)

Y/N/E/W

Checks the drawing for the standard set of parameters that are driven from model parameters. Standard parameters are set using the DRW_PARAMETER configuration option in the start configuration file.

Suggested Settings:

Inter	Batch	Regen	Save
E	E	E	E

PARENT_HI_COLOR

<Yellow/White/Gray/Blue/Red/Magenta/Cyan/Green/Brown>

Highlights parent objects in Pro/ENGINEER using the specified color. This option is used only when ModelCHECK simultaneously highlights a problematic feature and its parents.

PERC_EARLY_CHAMF

Defines the percentage of all features in a model, starting from the top of the Model Tree, in which chamfers must not be present.

PERC_EARLY_COSMETIC

Defines the early cosmetic features as a percentage of all the features in a model.

PERC_EARLY_DRAFT

Defines the percentage of all features in a model, starting from the top of the Model Tree, in which draft features must not be present.

PERC_EARLY_ROUND

Defines the percentage of all features in a model, starting from the top of the Model Tree, in which a round must not be present.

PLANE_CHILD (Datum Planes without Children)

Y/N/E/W

Reports any datum planes in the model, other than default planes, with no children. In the start part list in the start configuration file, you can specify a list of required standard datum planes for a model. The PLANE_CHILD check does not check these standard datum planes.

If any childless datum planes are found, you can highlight the features in question in the Pro/ENGINEER window.

ModelCHECK cannot highlight items on blanked layers.

You can also access the Global Reference Viewer from the ModelCHECK report to view all references to and from the reported features.

Suggested Settings:

Inter	Batch	Regen	Save
E	E	W	E

PLANE_PARENT (Datum Planes That Only Have One Parent)

Y/N/E/W

Reports the datum planes in the model that were created through other datum planes. If any are found, you can highlight the features in question in the Pro/ENGINEER window. ModelCHECK cannot highlight features on blanked layers.

You can also access the Global Reference Viewer from the ModelCHECK report to view all references to and from the reported features.

This check also reports datum planes with only one parent, where the datum is built through the parent. The PLANE_PARENT check does not check any standard datum planes in the start configuration file.

Suggested Settings:

Inter	Batch	Regen	Save
E	E	W	E

Pro/ENGINEER Build and Version

ModelCHECK can check when the current model was last saved to ensure that the proper version of Pro/ENGINEER was used. Use the following format in the start configuration file:

```
PRT_PRO_VERSION 1997360
ASM_PRO_VERSION 1998410
DRW_PRO_VERSION 1996320
```

Dates must be specified using the following format: YYYYWW0

where YYYY denotes the year, WW the week and 0 the first build of the week.

Note: The date must be an actual Pro/ENGINEER date code. For example, click **Help > About Pro/ENGINEER** to see the date code (manufacturing code) for your current session.

PRO_VERSION (Version of Pro/ENGINEER)

Y/N/E/W

Reports the version of Pro/ENGINEER that the model was last saved in. The following start configuration options are available:

- PRT_PRO_VERSION
- ASM_PRO_VERSION
- DRW_PRO_VERSION

Suggested Settings:

Inter	Batch	Regen	Save
W	W	W	W

PROGRAM

<Pro/ENGINEER start command>

Specifies the command to start Pro/ENGINEER. This option is used only in Batch mode.

RC_INCOMPLETED (RuleCHECK Rules That Are Not Complete)

Y/N/E/W

Checks to see if any RuleCHECK rules have been attached to the model. If so, it reports any rules in a pending or override state.

Suggested Settings:

Inter	Batch	Regen	Save
E	E	N	N

RC_PARAMETER_NAME

Determine the set of rules for RuleCHECK to apply to the model. If this line does not exist in the configuration file, the RC_MODEL_TYPE parameter is used by default.

REG_FEATURES (Resumed Features)

Y/N

Reports the number of features in the model that are resumed (not suppressed).

Suggested Settings:

Inter	Batch	Regen	Save
Y	Y	N	N

REGEN_DIMS (Dimensions That Cannot Regenerate)

Y/N/E/W

Reports any dimensions in the drawing that cannot be regenerated. This problem occurs if a dimension loses one of the entities it references. The entity may have been redefined or deleted. (only applies to the **MC Regen** option)

Suggested Settings:

Inter	Batch	Regen	Save
E	E	E	E

REGEN_ERRS (Regeneration Errors)

Y/N/E/W

Reports any errors when a model is fully regenerated. These are typically problems that are reported in the Pro/ENGINEER message window when a model is regenerated.

The `mc_regen.mcr` configuration file is used to specify the messages to search for and to determine whether a message is an error or a warning message.

Because this check can take considerable time, you run it with the **MC Regen** command or in Batch mode.

Suggested Settings:

Inter	Batch	Regen	Save
E	E	N	N

REGEN_WRNS (Regeneration Warnings)

Y/N/E/W

Reports any warnings when a model is fully regenerated. These are typically problems that are reported in the Pro/ENGINEER message window when a model is regenerated.

The `mc_regen.mcr` configuration file is used to specify the messages to search for and to determine whether a message is an error or a warning message.

Because this check can take considerable time, you run it with the **MC Regen** command or in Batch mode.

Suggested Settings:

Inter	Batch	Regen	Save
E	E	N	N

ModelCHECK Teacher: Dimensions that Will Not Regenerate

Sometimes when a drawing is retrieved, Pro/ENGINEER informs you that a highlighted dimension can not be regenerated. This means that a dimensional reference can not be found because it has been either redefined, deleted, or suppressed in the model.

Any dimension that Pro/ENGINEER can not regenerate will be displayed in red.

To successfully regenerate the dimension, the reference must be redefined or rerouted to a new entity.

Regeneration Messages

When a model is regenerated from its first feature, warning messages are sometimes displayed in the Pro/ENGINEER message window. ModelCHECK can report the messages as either errors or warnings. The checks to enable this are `REGEN_ERRS` and `REGEN_WRNS`.

The text that is searched for is configured in a file that has a default name of `mc_regen.mcr`, which is found in the ModelCHECK `config` directory.

The `MC_REGEN_CONFIG_FILE` configuration option in the start configuration file is used to specify the name and location of the `mc_regen.mcr` file as shown below:

```
MC_REGEN_CONFIG_FILE text\mc_regen.mcr
```

There are two sections to the `mc_regen.mcr` file, one for errors and another for warnings. Each line is designated by either an `E` or a `W`. Below is an example of what this file looks like:

```
# ModelCHECK Regen Config file (amn) 9-27-99
# This file contains a list of strings to search for
# among the lines that are output when MC Regen is run.
# The format is either E:strings or W:strings
# E means to consider all matching lines to be errors
# W means to consider all matching lines to be warnings

E:ERROR
E:Reference for the section entity no longer exists
E:WARNING: CUT is entirely outside the model
W:WARNING: Design intent is unclear
```

ModelCHECK Teacher: Regeneration Errors

A regeneration error is any warning message that Pro/ENGINEER reports to the message window when a model is regenerated.

What causes regeneration errors?

Regeneration problems can be caused by a wide variety of problems with the model. The list below describes some of them:

```
WARNING: external reference not present, SURFACE frozen (feat id: xxx).
```

```
WARNING: cross-section xxx may be incomplete.
```

```
WARNING: external reference not present, placement frozen (feat id: xxx).
```

```
WARNING: xxx is entirely outside the model.
```

```
WARNING: xxx is entirely inside the model.
```

ModelCHECK - Help Topic Collection

WARNING: xxx is entirely inside the volume; volume unchanged.

WARNING: xxx is entirely inside the model; model unchanged.

WARNING: xxx is entirely outside the volume; volume unchanged.

WARNING: xxx is entirely outside the model; model unchanged.

WARNING: Design intent is unclear.

WARNING: Design intent is unclear. Use "Geom Check" menu for details.

WARNING: Design intent is unclear. Use "Info"/"Geom Check" menu for details.

WARNING: Design intent is unclear in xxx.

WARNING: Design intent is unclear in xxx. Use "Info"/"Geom Check" in Part mode.

WARNING - Coordinate system xxx of assembly xxx has been frozen.

WARNING: external reference not present, coord system frozen (feat id: xxx).

WARNING: external reference not present, feature frozen (id:xxx).

WARNING - Datum (internal id = xxx) of assembly xxx has been frozen.

WARNING: external reference not present, datum plane frozen (feat id : xxx).

WARNING: external reference not present, placement frozen (feat id: xxx).

WARNING: external reference not present, SURFACE frozen (feat id: xxx).

WARNING: instance xxx no longer exists in driving UDF xxx.

WARNING: Can not update placememnt of member(Mxxx).

WARNING: Incomplete component xxx is frozen.

WARNING: Component xxx is frozen.

WARNING: external reference not present, SPRING BACK frozen (feat id: xxx).

WARNING: external reference not present, SURFACE frozen (feat id: xxx).

WARNING: Feature xxx (xxx) in assembly xxx is unattached.

WARNING: external reference not present, location frozen (feat id: xxx).

WARNING: xxx is entirely inside the model; model unchanged.

WARNING: xxx is entirely outside the model; model unchanged.

WARNING! Model geometry for drawing view is missing.

WARNING: merged feature xxx with obsolete external references.

WARNING: Design intent is unclear. Use "Geom Check" menu for details.

WARNING: external reference not present, datum axis frozen (feat id:xxx).

WARNING: external reference not present, datum point frozen (feat id: xxx) .

WARNING: Reference part xxx not found.

REL_UNWANTED (Unwanted Relations)

Y/N

Checks and removes unwanted relations in the model. Unwanted relations are specified in the start configuration file using the `PRT_REL_UNWANTED` and `ASM_REL_UNWANTED` start configuration options.

Relation and Relation Comments

ModelCHECK can check for standard relations and comment lines when it runs. Use the following format in the start configuration file:

```
PRT_RELATION MASS=mp_mass("")
PRT_COMMENT Sets the mass parameter to the mass value
PRT_RELATION D12=5
```

RELATION_COMM (Comments in Relations)

Y/N/E/W

Checks that every relation has at least one comment line.

Suggested Settings:

Inter	Batch	Regen	Save
W	W	N	W

RELATION_ERRS (Relation Errors)

Y/N/E/W

Checks for errors in the model's relations and reports the relation lines containing errors.

Suggested Settings:

Inter	Batch	Regen	Save
E	E	E	E

RELATION_INFO (Relation Information)

Y/N/E/W

Reports all the assembly or part relations and their respective comments.

Suggested Settings:

Inter	Batch	Regen	Save
Y	Y	N	N

RELATION_MISS (Relations That Are Missing)

Y/N/E/W

Checks for standard relations and their comments in parts and assemblies. If any are missing, ModelCHECK adds them to the model.

Standard relations and comments are listed in the configuration files using the `PRT_COMMENT`, `PRT_RELATION`, `ASM_COMMENT` and `ASM_RELATION` start configuration options.

If the ModelUPDATE mode is enabled, this check automatically adds standard relations and their comments, if any are missing, in parts and assemblies.

Suggested Settings:

Inter	Batch	Regen	Save
W	W	N	N

RELATION_MULT (Relations That Have Multiple Assignments)

Y/N/E/W

Checks that no dimensions and parameters have been assigned multiple times in the relations file.

Suggested Settings:

Inter	Batch	Regen	Save
E	E	N	N

RELATION_UPDATE (Relations That Need Update)

Y/N/E/W

Checks for relations in the model that need to be updated. Relations are defined using the `RELATION_UPDATE_FILE` configuration option in the start configuration file.

If the ModelUPDATE mode is enabled, this check automatically updates relations that need to be updated in the model.

Suggested Settings:

Inter	Batch	Regen	Save
E	E	N	N

Relation Update File

Specifies the name of the external text file in which relations are defined, in the start configuration file. For example:

```
RELATION_UPDATE_FILE text/rel_update.txt
```

The relation update file has the following format:

```
weight_kg = pro_mp_mass
PTC_WEIGHT_KG = pro_mp_mass
weight_lb = weight_kg * 2.205
PTC_WEIGHT_LB = PTC_WEIGHT_KG * 2.205
part_no = rel_model_name()
PTC_PART_NO = rel_model_name()
```

RENAMED_SYMBOLS (Renamed Dimension Symbols)

Y/N

Lists the names of the part dimension symbols that have been renamed.

Suggested Settings:

Inter	Batch	Regen	Save
Y	N	Y	N

REPT_LAYR_ALWAYS (Report Missing Layers)

Y/N

Always reports missing layers if set to Y. If set to N, missing layers will only be reported if a standard feature type for that layer exists in the model.

Suggested Settings:

Inter	Batch	Regen	Save
Y	Y	Y	Y

Required and Unacceptable Parameter Notes

Required parameter notes are defined in the start configuration file or in separate text files using the following format:

```
[MODE]_PARAM_NOTE_REQ [parameter] [file_name].txt
```

where

- [MODE] is PRT or ASM.
- [parameter] is the name of the parameter.
- [file_name] is the name of the text file for the required notes.

You can define a single note in the start configuration file as follows:

```
[MODE]_PARAM_NOTE_REQ [parameter] "[NOTE_TEXT]"
```

Unacceptable parameter notes are defined in the start configuration file or in separate text files using the following format:

```
[MODE]_PARAM_NOTE_UNACC [parameter] [file_name].txt
```

where

- [MODE] is PRT or ASM.
- [parameter] is the name of the parameter.
- [file_name] is the name of the text file for the unacceptable notes.

You can define a single note in the start configuration file as follows:

```
[MODE]_PARAM_NOTE_UNACC [parameter] "[NOTE_TEXT]"
```

For example:

```
PRT_PARAM_NOTE_REQ COMPANY notes.txt  
ASM_PARAM_NOTE_UNACC DATE "Hello"
```

ROUND_CHILD (Children of Rounds)

Y/N/E/W

Lists the features that are children of rounds. If any are found, they can be highlighted in the Pro/ENGINEER window.

You can also access the Global Reference Viewer from the ModelCHECK report to view all references to and from the reported features.

This check ignores children of other rounds, because this is not considered poor modeling.

Suggested Settings:

Inter	Batch	Regen	Save
E	E	E	E

RULECHECK_INFO (RuleCHECK Information)

Y/N/E/W

Runs RuleCHECK when ModelCHECK runs and provides a link to the RuleCHECK report.

Suggested Settings:

Inter	Batch	Regen	Save
Y	Y	N	N

SAVE_MC_PRE

<Y/N>

- **Y** - Runs ModelCHECK before a save operation. This option must be set to **Y** to ensure that the parameters that ModelCHECK writes to the model are saved with it.
- **N** - Runs ModelCHECK after the save operation.

Set this option to **N** if you are concerned about data loss. In the unlikely event that ModelCHECK causes Pro/ENGINEER to exit prematurely, this ensures that models are saved before Pro/ENGINEER exits prematurely.

Note: This option is applicable only in Save mode.

SAVE_MU

<Y/N>

Saves the models that have been updated in the ModelUPDATE mode.

SEARCH_DUP_MODELS (Search for Duplicate Models)

Y/N/E/W

Provides a **Search** for duplicate models in the active Windchill server registered in Pro/ENGINEER from the ModelCHECK report. Click **Search** to search the server for duplicate models and their details.

You can specify the tolerance percentage for the shape attributes using options in the constant configuration file (`MCSI1_TOL` through `MCSI5_TOL`). Only those models with all the attributes within the tolerance range are considered as duplicate models and are reported.

Suggested Settings:

Inter	Batch	Regen	Save
W	W	W	W

SHTMTL_THICK (Standard Sheet Metal Wall Thicknesses)

Y/N/E/W

Reports whether sheet metal parts have been modeled using standard wall thickness. If any are found, you can highlight the features in question in the Pro/ENGINEER window.

Standard wall thicknesses are listed in a text file specified by the `STD_SHTMTL_THICK_FILE` start configuration option.

Suggested Settings:

Inter	Batch	Regen	Save
E	E	E	E

SHTMTL_UNBENDS (Sheet Metal Unbends)

Y/N/E/W

Checks for consecutive unbend and bend-back (or vice versa) features in sheet metal parts. If any are found, delete these redundant features.

Suggested Settings:

Inter	Batch	Regen	Save
W	W	W	W

SHTMTL_YFACTOR (Sheet Metal Y-Factor)

Y/N

Reports the sheet metal Y-Factor used for sheet metal parts.

Suggested Settings:

Inter	Batch	Regen	Save
Y	Y	N	N

ModelCHECK Teacher: Simplified Representations

Simplified representations are used to simplify the geometry of a part or a component in an assembly. This increases the speed in which you are able to retrieve, regenerate and repaint your model in Pro/ENGINEER.

SIMPREP_INFO (Simplified Representations)

Y/N

Reports whether any simplified representations associated with the model exist.

Suggested Settings:

Inter	Batch	Regen	Save
Y	Y	Y	Y

SIMPREP_NAME (Simplified Representation Names)

Y/N/E/W

Checks that the name of simplified representations follows the standard naming convention defined by the `PRT_SIMPREP_NAME` and `ASM_SIMPREP_NAME` start configuration options.

Suggested Settings:

Inter	Batch	Regen	Save
E	E	W	W

SKETCH_ITEMS (Number of Entities in a Sketched Feature)

Y/N/E/W

Counts the number of geometric entities (lines, arcs, points) in a sketched feature and verifies that the number is less than a maximum value. Dimensions are not counted as entities. The maximum value can be defined with the `MAX_SKETCH_ITEMS` constant configuration option.

If the number of entities in a feature exceeds the maximum value, the feature is reported and you can highlight it in the Pro/ENGINEER window.

You can also access the Global Reference Viewer from the ModelCHECK report to view all references to and from the reported features.

Suggested Settings:

Inter	Batch	Regen	Save
N	N	N	N

SKIP_MODELS

<Y/N>

Specifies whether ModelCHECK must skip the checking of models that have not changed after they were retrieved.

- *Y* - Skips checking the model irrespective of the value of the `MC_ERRORS` parameter if the model has not changed after retrieval.
- *N* - Skips checking the model only if the value of the `MC_ERRORS` parameter is 0 and the model has not changed after retrieval. This is the default.

Note: The `SKIP_MODELS` configuration option is ignored if the `CHECK_ALL_MODELS` configuration option is set to *Y*.

ModelCHECK Teacher: SLA (STL) Information

SLA stands for stereolithography. A stereolithography machine creates a 3-dimensional solid part from a CAD model using the information provided in an SLA (STL) file. This file can be generated from within Pro/ENGINEER by choosing **Interface, Export, STL** in both part and assembly modes.

While creating the SLA file, Pro/ENGINEER translates the solid part or assembly into surfaces comprised of small polygons. The new model information is then stored in a text file that is read by the SLA machine.

If it is not possible to generate the SLA (STL) information file, Pro/ENGINEER normally returns one of the following errors in its message window:

- Unable to triangulate
- Failed to triangulate

In order for ModelCHECK to determine if it is possible to create an STL file of your model, it attempts to create one. For this reason, you may see the above error messages in Pro/ENGINEER's message window while running ModelCHECK.

Problems with SLA generally stem from design flaws like small gaps in surfaces. They can sometimes be overcome by reducing the chord height (the straight line which approximates the surface topology). If this does not work, you will have to investigate the model for flaws. Start by looking for geometry checks. If there are none, try to generate an STL file from the Interface menu. Pro/ENGINEER will not be able to generate the file, but it will go into a mode which allows you to highlight the problem areas where surfaces can not be triangulated.

SLA_INFO (SLA Information)

Y/N/E/W

Reports whether it is possible to generate an SLA output file of the model. This check takes a relatively long time. If you are concerned about speed, turn it off.

Suggested Settings:

Inter	Batch	Regen	Save
W	W	N	W

ModelCHECK Teacher: Small Cylindrical Surfaces and Edges

Cylindrical surfaces are present in features that have round surfaces such as a circular hole, a protrusion or a round.

ModelCHECK searches for cylindrical surfaces and edges in your model that are smaller than a value specified by your administrator. If any are found, ModelCHECK will report them. You can use your Web browser to highlight the features in question directly in Pro/ENGINEER to make it easier to identify and fix them.

Why are small cylindrical surfaces and edges dangerous?

Small edges or cylindrical surfaces should be avoided in modeling because they are difficult to manufacture.

SMALL_CYLSRF (Small Cylindrical Surfaces)

Y/N/E/W

Lists the features that have cylindrical surfaces (such as rounds and holes) and small radii. You can define the minimum radius with the `SMALL_RADIUS` constant configuration option. If any are found, the features in question can be highlighted in the Pro/ENGINEER window.

You can also access the Global Reference Viewer from the ModelCHECK report to view all references to and from the reported features.

Suggested Settings:

Inter	Batch	Regen	Save
E	E	E	E

SMALL_RADIUS

Defines the minimum radius of cylindrical surfaces (for rounds, holes, and so on).

SO21_DIST_VERT_EDGE (Distance to Vertex Edge)

Y/N/E/W

GeomIntegrityCHECK reports the vertex and the edge in a solid if the distance between the two elements exceeds the tolerance value specified in your configuration file.

Suggested Settings:

Inter	Batch	Regen	Save
E	E	N	N

SO22_DIST_VERT_FACE (Distance to Vertex Face)

Y/N/E/W

GeomIntegrityCHECK reports the vertex and the face in a solid if the distance between the two elements exceeds the tolerance value specified in your configuration file.

Suggested Settings:

Inter	Batch	Regen	Save
E	E	N	N

SO23_HIST_DELETE (Deletion of History)

Y/N/E/W

GeomIntegrityCHECK reports the B-reps in a solid if they have been imported into the existing model.

Suggested Settings:

Inter	Batch	Regen	Save
E	E	N	N

SO24_EXTRA_GEOM (Auxiliary Geometry)

Y/N/E/W

GeomIntegrityCHECK reports the solid elements that are hidden from view (for example, cut-off component part areas and dead branches).

In addition, it reports added material in component part areas that are already filled with material, without altering the component part in any way (for example, addition of a ball or sphere to a rectangular solid).

GeomIntegrityCHECK also reports geometrical elements that have no logical relationship to the given solid.

Suggested Settings:

Inter	Batch	Regen	Save
E	E	N	N

SO25_CAVITIES (Cavities)

Y/N/E/W

GeomIntegrityCHECK reports solids that are fully contained in another solid and are to be fully subtracted from.

Suggested Settings:

Inter	Batch	Regen	Save
E	E	N	N

SO26_MULT_BODY (Multi-Body Solids)

Y/N/E/W

GeomIntegrityCHECK reports solids that contain two volumes that do not touch each other. It considers the two volumes to be separate bodies, which is unacceptable in a single solid.

Suggested Settings:

Inter	Batch	Regen	Save
E	E	N	N

SO27_MULT_SOLID (Multi-Solid Parts)

Y/N/E/W

In an assembly environment, there is generally only one solid in one part. If there is more than one solid in a model, GeomIntegrityCHECK reports them as separate solids.

Suggested Settings:

Inter	Batch	Regen	Save
E	E	N	N

SRF_EDGES (Surface Gaps and Overlaps)

Y/N/E/W

Lists the edges with either gaps or overlaps between the surfaces that meet. If any are found, you can highlight the features in question in the Pro/ENGINEER window.

You can also access the Global Reference Viewer from the ModelCHECK report to view all references to and from the reported features.

This check takes a relatively long time. If you are concerned about speed, turn it off.

Suggested Settings:

Inter	Batch	Regen	Save
E	E	N	N

Standard Datums

Standard datums (datum axes, coordinate systems, curves, planes, and points) and their placement in the feature list can be verified. Use the following format in the start configuration file to set the standard datums:

```
[MODE]_DATUM_[ITEM] [item_name] [#]
```

where

- [MODE] is PRT or ASM.
- [ITEM] is AXIS, PLANE, CSYS, POINT, or CURVE.
- [item_name] is the name of the item. If the name of the item is not important, use the word NONE.
- [#] is the feature number. If only the feature name is important, you can omit the feature number.

Note: In assemblies, the feature number is not the number assigned by Pro/ENGINEER; it is the sequential feature number in the assembly, after ignoring skeleton parts if any.

For example,

```
PRT_DATUM_AXIS A_1
PRT_DATUM_PLANE DTM1 1
PRT_DATUM_PLANE DTM2 2
PRT_DATUM_PLANE DTM3 3
PRT_DATUM_CSYS NONE 4
ASM_DATUM_POINT PNT_1
ASM_DATUM_CURVE CURVE_1
ASM_DATUM_PLANE ADTM1 1
```

Standard Model Notes

Models can be checked to verify the presence of standard notes. Use the following format in the start configuration file to define the standard model notes:

```
[MODE]_STD_NOTE [NOTE_TEXT]
```

where

- [MODE] is PRT or ASM.
- [NOTE_TEXT] is the text for the note.

You can define any number of single-line standard notes using separate lines for each note. To define notes with multiple lines, use a separate text file as follows:

```
[MODE]_STD_NOTE FILE:[file_name].txt
```

ModelCHECK Teacher: Start Part and Start Assembly Items

Start part and start assembly items are a group of features that your company has set as a standard starting point for every part and assembly. These features are normally added to the model when it is created, and can be automated with the help of a map key or a menu pick in Pro/ENGINEER.

Start features can be any of the following:

- Datum Planes
- Datum Coordinate Systems
- Datum Axes
- Datum Points
- Datum Curves
- Parameters
- Layers
- Views

In many cases, you will have different requirements for your start features depending on the type of model you are creating, or whether it is a part or assembly.

Using Start Features has many advantages including:

- It makes it easier for other users to understand your model.
- It makes it easier for you to assemble parts together because assembly references can be identified in a standard manner.
- Maintaining company wide consistency.
- Ensures that default datum planes are always used.

ModelCHECK supports the following start features:

Feature	Name for Part Mode	Name for Assembly Mode
Datum Plane	PRT_DATUM_PLANE	ASM_DATUM_PLANE
Datum CSYS	PRT_DATUM_CSYS	ASM_DATUM_CSYS
Datum Axis	PRT_DATUM_AXIS	ASM_DATUM_AXIS
Datum Point	PRT_DATUM_POINT	ASM_DATUM_POINT

Feature	Name for Part Mode	Name for Assembly Mode
Datum Curve	PRT_DATUM_CURVE	ASN_DATUM_CURVE
Parameter	PRT_PARAMETER	ASM_PARAMETER
PDM Parameter	PRT_PARAM_PDM	ASM_PARAM_PDM
NULL Parameter (non empty)	PRT_PARAM_NULL	ASM_PARAM_NULL
Layer	PRT_LAYER	ASM_LAYER
View	PRT_VIEW	ASM_VIEW

Your company has the following standard start features:

- Three default datum planes called DTM1, DTM2, DTM3
- A PDM designated parameter called PN which is the model's part number
- Three views called TOP, SIDE and ISO

STARTCHECK (Start Part and Start Assembly Check)

Y/N/E/W

Verifies that the items in the start part and start assembly lists are in the model and have been created in the standard order (That is, default datum planes should be features 1, 2, and 3.) Start-part features can be datum planes, coordinate systems, curves, points, views, parameters, or layers.

If any parameters or layers are missing, ModelCHECK can automatically add them to the model.

Start-part items are defined in the start configuration file with the following configuration options: PRT_DATUM_PLANE, PRT_DATUM_CSYS, PRT_DATUM_POINT, PRT_DATUM_CURVE, PRT_DATUM_POINT, PRT_VIEW, PRT_PARAMETER and PRT_LAYER.

Tolerance types are checked as part of the start part. These are specified using the PRT_TOL_TYPE and ASM_TOL_TYPE start configuration options. The allowable types of tolerances are DIN/ISO or ANSI.

Suggested Settings:

Inter	Batch	Regen	Save
E	E	W	W

Missing Layers

Verifies that the standard list of layers exists in the model. This check is automatically enabled when STARTCHECK is enabled.

If any layers are missing, ModelCHECK can add them to the model. If the standard feature type for a layer (as specified in the start configuration file) does not exist in the model, ModelCHECK reports the layer as missing only if the `REPT_LAYR_ALWAYS` check is set to `Y`.

If the ModelUPDATE mode is enabled, this check automatically adds missing layers to the model.

Missing Parameters

Verifies that the standard list of parameters exists in the model. This check is automatically enabled when `STARTCHECK` is enabled.

If any parameters are missing, ModelCHECK can add them to the model. If the ModelUPDATE mode is enabled, this check automatically adds those missing parameters to the model that do not require manual interaction such as typing or selection.

STD_DTL_SETUP (Drawing Detail File)

Y/N/E/W

Compares the current detail settings to a standard drawing detail file on disk. If any differences are found, ModelCHECK can reset the detail settings to the values listed in the standard drawing detail file.

Different standard drawing detail files can be specified for different formats using the `STD_DRW_DTL_FILE` start configuration option.

Suggested Settings:

Inter	Batch	Regen	Save
E	E	W	W

STD_NOTES_MISSING (Missing Standard Notes)

Y/N/E/W

Verifies that all standard model notes exist in the model and reports the number of missing notes. You can define the standard notes in the start configuration file using the `PRT_STD_NOTE` and `ASM_STD_NOTE` start configuration options.

Suggested Settings:

Inter	Batch	Regen	Save
Y	Y	Y	Y

SU10_BOUND_ANGLE (Angle Between Edge Curves)

Y/N/E/W

GeomIntegrityCHECK checks whether the angle between the boundary curves of naturally bounded surfaces lies within the critical range around 0° or 180° or not. It measures the angles between the tangents of neighboring boundary curves and compares them with the specified configuration value.

Suggested Settings:

Inter	Batch	Regen	Save
E	E	N	N

SU11_NORM_REVERSAL (Reversal of Normals)

Y/N/E/W

GeomIntegrityCHECK reports the ranges of naturally bounded surfaces in which it finds a significant local change in the difference of the normal angle.

Suggested Settings:

Inter	Batch	Regen	Save
E	E	N	N

SU12_PATCH_DIST (Patch Distribution)

Y/N/E/W

GeomIntegrityCHECK reports the surfaces on which the number of patches exceeds the number specified in your configuration file.

Suggested Settings:

Inter	Batch	Regen	Save
E	E	N	N

SU13_UNOC_PATCH_ROW (Unoccupied Patch Rows)

Y/N/E/W

GeomIntegrityCHECK reports the surfaces with unoccupied patch rows. That is, GeomIntegrityCHECK reports the patch rows on every outside boundary curve of a bounded surface with boundary curves.

Suggested Settings:

Inter	Batch	Regen	Save
E	E	N	N

SU8_TINY_SEG_EDGE (Tiny Segment Edge)

Y/N/E/W

GeomIntegrityCHECK reports the faces and face patches whose extents are smaller in one parameter direction than specified in your configuration file.

Suggested Settings:

Inter	Batch	Regen	Save
E	E	N	N

SU9_TINY_CURV_RAD (Minimum Curvature Radius)

Y/N/E/W

GeomIntegrityCHECK reports the ranges of naturally bounded surfaces in which the curvature radius is less than the value in your configuration file. It also reports the places in which the normal to a face is not defined and where no curvature radius can be determined.

Suggested Settings:

Inter	Batch	Regen	Save
E	E	N	N

SUP_COMPONENTS (Suppressed Components)

Y/N/E/W

Checks for any suppressed components in the assembly.

You can also access the Global Reference Viewer from the ModelCHECK report to view all references to and from the reported components.

Suggested Settings:

Inter	Batch	Regen	Save
W	W	N	W

SUP_FEATURES (Suppressed Features)

Y/N/E/W

Lists the types and IDs of the suppressed features in the model. Any features that are included in family tables or sheet metal flat-pattern features are ignored.

Suggested Settings:

Inter	Batch	Regen	Save
W	W	N	W

SYMBOL_INFO (Symbol Information)

Y/N

Lists the names of symbols in the drawing.

Suggested Settings:

Inter	Batch	Regen	Save
Y	Y	N	N

SYMBOL_SPELL (Spelling Mistakes in Symbols)

Y/N/E/W

Checks drawing symbols for spelling mistakes. If any are found, you can highlight them or highlight and correct them. Also, you can add the word to the dictionary so that ModelCHECK accepts it as correct.

Suggested Settings:

Inter	Batch	Regen	Save
E	E	W	E

T18_NUM_FACE (Junction or Number of Faces Per Edge)

Y/N/E/W

GeomIntegrityCHECK checks for topological consistency (that is, the explicitness and the unity of surface groups) and absence of junctions. It reports the location of multiple junctions.

Suggested Settings:

Inter	Batch	Regen	Save
E	E	N	N

T19_NORMAL_ORIENT (Orientation of Similar Normals)

Y/N/E/W

GeomIntegrityCHECK checks whether all the normals of neighboring faces in a group have the same orientation. It reports the faces with normals whose orientation differs from the orientation of the majority of normals in the same face.

Suggested Settings:

Inter	Batch	Regen	Save
E	E	N	N

T20_KNIFE_EDGES (Knife Edge)

Y/N/E/W

GeomIntegrityCHECK reports the faces of composite surfaces whose angle between the tangential planes on a common boundary curve (or parts thereof) shows properties of a minute angle of nearly 0 degrees. At the restart points and fulcrums, GeomIntegrityCHECK calculates the angle between the tangential planes. GeomIntegrityCHECK reports all angles that are around 0 degrees.

Suggested Settings:

Inter	Batch	Regen	Save
E	E	N	N

TABLE_CELLS (Table Cells)

Y/N/E/W

Verifies that specific table cells contain standard text. Standard table cell text is designated using the DRW_TABLE_CELLS configuration option in the start configuration file.

Suggested Settings:

Inter	Batch	Regen	Save
E	E	W	W

TITLE_INFO (Title Block Information)

Y/N/E/W

Reports any entries in the title block that are not driven by model parameters.

Suggested Settings:

Inter	Batch	Regen	Save
W	W	W	W

TITLE_SPELL (Title Block Spelling Errors)

Y/N/E/W

Checks the title block for spelling mistakes. If any mistakes are found, you can highlight them or highlight and correct them. Also, you can add the word to the dictionary so that ModelCHECK accepts it as correct.

Note: The TITLE_SPELL check works only if the NOTE_SPELL check is active.

Suggested Settings:

Inter	Batch	Regen	Save
E	E	N	E

ModelCHECK Teacher: Sharp Edges

Edges are designated as being sharp when the angle between the two surfaces that meet (forming the edge) fall below a standard angle. The angle is customizable by your administrator. In the example below, an edge was found with an angle of 8 degrees between the two surfaces; the configuration file was set to generate a warning if any angles were below 10 degrees.

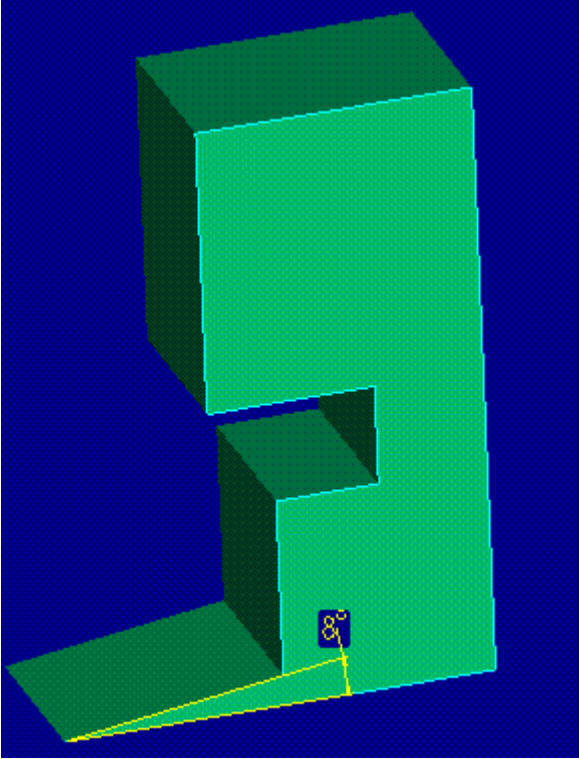

Why are sharp edges dangerous?

There are numerous reasons why edges should not be too sharp:

- It is difficult to mold a part if the edges are too sharp.
- It is difficult to manufacture parts.
- You will have a difficult time adding rounds, chamfers, or drafts to sharp edges.

SHARP_ANGLE

Defines the minimum angle between two surfaces that are considered sharp.

SHARP_EDGES (Sharp Edges)

Y/N/E/W

Lists the sharp edges in the model. Sharp edges are defined by a specified angle between the two surfaces that intersect at the edge. The angle is set using the `SHARP_ANGLE` constant configuration option. If any are found, the features in question can be highlighted in the Pro/ENGINEER window.

You can also access the Global Reference Viewer from the ModelCHECK report to view all references to and from the reported features.

This check takes a relatively long time. If you are concerned about speed, turn it off.

Suggested Settings:

Inter	Batch	Regen	Save
E	E	N	N

Sheet Metal Bend Table

Standard sheet metal bend tables are listed in the start configuration file as shown in the following example:

```
SHTMTL_BTNAME Bend_1
```

Sheet Metal Thickness File

Specifies the name of the external text file in which standard sheet metal wall thicknesses are listed in the start configuration file. For example:

```
STD_SHTMTL_THICK_FILE c:\apps\mc\config\text\thick.txt
```

The sheet metal thickness file has the following format:

```
# ModelCHECK Standard Sheet Metal Thicknesses File
#
UNIT INCH
.125
.25
.375
UNIT MM
0.5
2
3
4
```

Note: The declaration of units must be in uppercase.

SHEET_SIZE_INFO (Sheet Size Information)

Y/N/E/W

Lists the number of sheets in the drawing and their respective sizes.

Suggested Settings:

Inter	Batch	Regen	Save
Y	Y	N	N

SHORT_EDGE and SHORT_EDGE_BATCH

Defines the minimum length of edges before ModelCHECK considers them short.

Two values are available for the `SHORT_EDGE` configuration option:

- A numeric value.
- The string `CALCULATE`. In Interactive mode, ModelCHECK automatically calculates a suggested value for short edges and applies it to the model being checked.

In Batch mode, ModelCHECK does not calculate the suggested value for short edges. The `SHORT_EDGE_BATCH` configuration option is used to set the value in this case.

The value of the `SHORT_EDGE_BATCH` configuration option is only used if the `SHORT_EDGE` configuration option is set to `CALCULATE`. Otherwise, the value of the `SHORT_EDGE` configuration option overrides the value of the `SHORT_EDGE_BATCH` configuration option.

SHORT_EDGES (Short Edges)

Y/N/E/W

Lists the edges in the model with a length smaller than a specified limit. You can define the limit for the length using the `SHORT_EDGE` constant configuration option. If any short edges are found, the features in question can be highlighted in the Pro/ENGINEER window.

You can also access the Global Reference Viewer from the ModelCHECK report to view all references to and from the reported features.

The value for `SHORT_EDGE` can be set to `CALCULATE`. If this is the case, the value used to determine a short edge is based on the size of the model.

Suggested Settings:

Inter	Batch	Regen	Save
E	E	E	E

SHOW_REPORT

<Y/N>

Configures whether the ModelCHECK report should be displayed in the browser or not. The default is `Y`.

Note: Set this configuration option for each operating mode.

SHTMTL_BENDTAB (Sheet Metal Bend Tables)

Y/N/E/W

Checks that the bend table used for a sheet metal part comes from a standard list. Standard bend tables are defined using the `SHTMTL_BTNAME` configuration option in the start configuration file.

Suggested Settings:

Inter	Batch	Regen	Save
W	W	W	W

SHTMTL_FLAT (Sheet Metal Flat Patterns or Flat States)

Y/N/E/W

Checks for the existence of flat patterns or flat states in sheet metal parts.

A flat state is a completely unbent copy of your part. It streamlines the creation of flat patterns needed in manufacturing. You can create any number of flat states, at any time in your design process, whether your part is fully formed or fully flat. Flat states are managed with family tables.

A flat pattern is a feature that shows the model in its flat state. It is always positioned as the last feature. When new features are added, the flat pattern automatically moves to the end of the feature list. Flat patterns allow you to start working on drawings before the sheet metal part is finished.

Suggested Settings:

Inter	Batch	Regen	Save
W	W	Y	W

ModelCHECK Teacher: Dimensional Tolerances

This page is part of a series of instructional web pages which accompany ModelCHECK. The ModelCHECK Teacher is designed as an instructional tool to assist users in understanding modeling errors. This reduces the likelihood of them being repeated and thus improves modeling skills. ModelCHECK Teacher can be accessed from the information files for relevant checks.

Tolerance Type

ModelCHECK can verify the type of tolerance used for the model. Two types are available, ANSI and DIN/ISO. Use the following format in the start configuration file:

```
PRT_TOL_TYPE ANSI
PRT_TOL_TYPE DIN/ISO
```

UDF_INFO (UDF Information)

Y/N

Lists the UDFs found in the model and the groups to which they belong.

Suggested Settings:

Inter	Batch	Regen	Save
Y	Y	N	N

Unacceptable Notes in Drawings

Unacceptable text is defined in the start configuration file or in separate text files using the following syntax:

```
DRW_NOTE_UNACC [NOTE_TEXT]
```

This text is case sensitive.

If a separate text file is used, it is designated in the start configuration file as follows:

```
STD_DRW_INFO_FILE [FILE_NAME]
```

ModelCHECK Teacher: Sheet Metal Parts with Consecutive Unbend and Bend Back Features

An unbend feature is used to unbend any curved surface on a sheet metal part, whether it is a bend feature or a curved wall.

A bend back feature is used to bend a surface back to its original shape (with a bend).

Often it is necessary to use an unbend to add a feature like a cut to a model. Once the feature is added, a bend back feature is used to return the part back to its original shape.

ModelCHECK notifies you if there are any features in the model that have consecutive unbend and bend back features (or vice versa) because they are redundant features.

How can sheet metal parts with consecutive unbend and bend back features be avoided?

If you create an unbend feature and then decide you do not need it, do not create a bend back feature, delete it. The same applies if you create a bend back feature.

If ModelCHECK tells you that there are consecutive unbend and bend back features, delete them.

UNITS_LENGTH (Length Units)

Y/N/E/W

Checks that the length units are from a standard list of acceptable units. Standard length unit types are designated in the start configuration file using the `PRT_UNITS_LENGTH` and `ASM_UNITS_LENGTH` configuration options.

Suggested Settings:

Inter	Batch	Regen	Save
W	W	W	W

UNITS_MASS (Mass Units)

Y/N/E/W

Checks that the mass units are from a standard list of acceptable units. Standard mass unit types are designated in the start configuration file using the PRT_UNITS_MASS and ASM_UNITS_MASS configuration options.

Mass types are case sensitive. Units must be properly defined using the following key words:

- KILOGRAM
- POUND

Suggested Settings:

Inter	Batch	Regen	Save
W	W	Y	W

UNQ_COMPONENTS (Unique Components)

Y/N

Reports the number of unique components in an assembly.

Suggested Settings:

Inter	Batch	Regen	Save
Y	Y	N	N

ModelCHECK Teacher: Unused Models

There are two steps to adding a Pro/ENGINEER model to a drawing. The first is to add it to the drawing and the second is to create a view which displays the model.

Additional models can be added to the drawing by selecting **Views, Dwg Models, Add Models**. Sometimes a user will inadvertently add more models to the drawing than are required. The problem with this is that the more models a drawing has associated to it, the larger the file size will become. Also, each model associated with a drawing has to be retrieved into memory and regenerated when the drawing is retrieved, which could greatly increase the time it takes to bring drawings into session.

There are two ways to determine what models are added to the drawing. The first is in the Drawing menu and allows you to set the current model (**Set Model**). The second and more effective way is: **Views, Dwg Models** which brings you into a menu where you can set the current model, add new ones, or delete unwanted ones.

There are times when it is necessary to add a model to a drawing and not display it. An example of this is when a model is needed for parameter information, but is not needed in a view.

UNUSED_MODELS (Unused Models in Drawings)

Y/N/E/W

Checks for any models added to the drawing that have not been used in a view. If any are found, you can delete them from the drawing.

If the ModelUPDATE mode is enabled, this check automatically deletes models that have not been used in a view from the drawing.

Suggested Settings:

Inter	Batch	Regen	Save
E	E	N	E

UNUSED_SHEETS (Empty Sheets)

Y/N/E/W

Checks for empty sheets in the drawing. If any are found, you can delete them from the drawing.

If the ModelUPDATE mode is enabled, this check automatically deletes empty sheets from the drawing.

Suggested Settings:

Inter	Batch	Regen	Save
E	E	N	E

Unwanted Relations for ModelUPDATE

You can specify the names of unwanted relations. ModelUPDATE removes the unwanted relations if configured to do so in the REL_UNWANTED check. Use the following format in the start configuration file:

```
PRT_REL_UNWANTED [relation]
ASM_REL_UNWANTED [relation]
```

You can use an external text file to list the unwanted relations as follows:

```
PRT_REL_UNWANTED text/unwanted_relations.txt
```

UPDATE_INTER_ASM

<Y/N>

Updates interchange assemblies in the ModelUPDATE mode.

UPDATE_SHEETMETAL

<Y/N>

Updates sheet metal parts in the ModelUPDATE mode.

UPDATE_SKELETON

<Y/N>

Updates skeleton parts in the ModelUPDATE mode.

VIEW_INFO (View Information)

Y/N

Lists any named views in the model.

Suggested Settings:

Inter	Batch	Regen	Save
Y	Y	N	N

VIEW_SCALE (Scale Assigned to Views)

Y/N/E/W

Checks for views in a drawing that have a scale assigned to them and reports the views that do not. The reported views can be highlighted.

Suggested Settings

Inter	Batch	Regen	Save
W	W	N	W

Views

Standard views are listed in the start configuration file as shown in the following example:

```
PRT_VIEW FRONT
ASM_VIEW SIDE
```

Specify the standard names of views for the model.

WC_DUPINFO

<Y/N>

Designates mass property parameters to store the shape information for models in the Windchill database. ModelCHECK uses these parameters to search the Windchill database for duplicate models.

XSEC_INFO (Cross Section Information)

Y/N

Lists all cross sections in the model.

Suggested Settings:

Inter	Batch	Regen	Save
Y	Y	N	N

Index

G

GeomIntegrityCHECK

- All Geom Type Checks 80
- config.gmc file..... 80
- Curve and Drawing Checks..... 80
- Faces Checks 80
- Solids Checks 80
- Surface Checks..... 80
- Topology Checks..... 80
- VDA Standards 80

GeomIntegrityCHECK 80

M

ModelCHECK

- Configuring ModelCHECK 2
- Configuring Report Titles..... 2, 71
- Environments 2
- Optimizing 75
- Reports 2
- Running with PDM..... 2, 12
- Starting ModelCHECK 2
- Teacher 2
- Using with Windchill 13

ModelCHECK 2

ModelCHECK 2

ModelCHECK 12

ModelCHECK 13

ModelCHECK 71

ModelCHECK 75

ModelCHECK Files

- Check Configuration 9, 40

condition.mcc 9, 32

config_init.mc 9, 14

Constant Configuration..... 9, 66

External 9, 63

Group 36

setconf.mcc 9, 29

Start Configuration 9, 57

Status Configuration 9, 69

ModelCHECK Files 9

ModelCHECK Files 14

ModelCHECK Files 29

ModelCHECK Files 32

ModelCHECK Files 36

ModelCHECK Metrics Tool

Accessing training database 114, 117, 119

Administrative tasks . 110, 117, 118, 119, 120

Capabilities..... 109, 110

Check distribution graph..... 122, 123

Checking quality goals 117, 120

Creating database tables 111

Defining checksets..... 117, 118

Displaying graphs 110, 115, 120, 127

Error-warning graph .. 120, 121, 122

Invoking the tool..... 110

Metrics database 114

ModelCHECK runs..... 123

Overview..... 109, 116

Preferences for graphs 127

ModelCHECK - Help Topic Collection

Preferences for reports	128	ModelCHECK modes	4
Searching failed checks	129	ModelCHECK modes	5
Setting data filters	126	ModelCHECK modes	5
Setting preferences	116, 125	ModelCHECK modes	6
Setup	110	ModelCHECK modes	8
Task sets	110	ModelCHECK Reports	
Training costs graph.....	124, 125	Configuring Report Titles	71
Training database	114	ModelUPDATE Report	74
Troubleshooting.....	115	Summary Reports	74
Types of graphs.....	116, 120	ModelCHECK Reports.....	71
User database	115	ModelCHECK Reports.....	74
User experience graph.....	124	R	
Viewing ModelCHECK data .	117, 118	RuleCHECK	
Viewing user experience ...	115, 117, 119, 124	Defining Rules.....	77
ModelCHECK Metrics Tool	109	Hard Rules	77
ModelCHECK modes		Implementing Rules.....	77
Batch	6, 8	Integrating with ModelCHECK.	77, 78
Interactive	4	Soft Rules	77
ModelUPDATE.....	9	RuleCHECK.....	76
Regenerate	5	RuleCHECK.....	77
Save	5	RuleCHECK.....	78
		RuleCHECK.....	78